



DCX1000
DCX3000

DCX3000-DPT
DCX3000-DVR

DCX-VGA
DCX3000-DVT

DCX KVM Matrix Switch

High-Performance Digital KVM Matrix Switch.

Shielded CAT6/CAT6A/CAT7 cables are required.



Customer
Support
Information

Order toll-free in the U.S. or for FREE technical support 24/7: Call 877-877-BBOX
(outside U.S. call 724-746-5500)
www.blackbox.com • info@blackbox.com

Trademarks Used in this Manual

Black Box and the Double Diamond logo are registered trademarks of BB Technologies, Inc.

Any other trademarks mentioned in this manual are acknowledged to be the property of the trademark owners.

We're here to help! If you have any questions about your application or our products, contact Black Box Tech Support at **877-877-2269** or go to **blackbox.com** and click on "Talk to Black Box." You'll be live with one of our technical experts in less than 60 seconds.

Federal Communications Commission and Industry Canada Radio Frequency Interference Statements

This equipment generates, uses, and can radiate radio-frequency energy, and if not installed and used properly, that is, in strict accordance with the manufacturer's instructions, may cause interference to radio communication. It has been tested and found to comply with the limits for a Class A computing device in accordance with the specifications in Subpart B of Part 15 of FCC rules, which are designed to provide reasonable protection against such interference when the equipment is operated in a commercial environment. Operation of this equipment in a residential area is likely to cause interference, in which case the user at his own expense will be required to take whatever measures may be necessary to correct the interference.

Changes or modifications not expressly approved by the party responsible for compliance could void the user's authority to operate the equipment.

This digital apparatus does not exceed the Class A limits for radio noise emission from digital apparatus set out in the Radio Interference Regulation of Industry Canada.

Le présent appareil numérique n'émet pas de bruits radioélectriques dépassant les limites applicables aux appareils numériques de la classe A prescrites dans le Règlement sur le brouillage radioélectrique publié par Industrie Canada.

Disclaimer:

Black Box Network Services shall not be liable for damages of any kind, including, but not limited to, punitive, consequential or cost of cover damages, resulting from any errors in the product information or specifications set forth in this document and Black Box Network Services may revise this document at any time without notice.

Instrucciones de Seguridad

(Normas Oficiales Mexicanas Electrical Safety Statement)

1. Todas las instrucciones de seguridad y operación deberán ser leídas antes de que el aparato eléctrico sea operado.
2. Las instrucciones de seguridad y operación deberán ser guardadas para referencia futura.
3. Todas las advertencias en el aparato eléctrico y en sus instrucciones de operación deben ser respetadas.
4. Todas las instrucciones de operación y uso deben ser seguidas.
5. El aparato eléctrico no deberá ser usado cerca del agua—por ejemplo, cerca de la tina de baño, lavabo, sótano mojado o cerca de una alberca, etc.
6. El aparato eléctrico debe ser usado únicamente con carritos o pedestales que sean recomendados por el fabricante.
7. El aparato eléctrico debe ser montado a la pared o al techo sólo como sea recomendado por el fabricante.
8. Servicio—El usuario no debe intentar dar servicio al equipo eléctrico más allá a lo descrito en las instrucciones de operación. Todo otro servicio deberá ser referido a personal de servicio calificado.
9. El aparato eléctrico debe ser situado de tal manera que su posición no interfiera su uso. La colocación del aparato eléctrico sobre una cama, sofá, alfombra o superficie similar puede bloquea la ventilación, no se debe colocar en libreros o gabinetes que impidan el flujo de aire por los orificios de ventilación.
10. El equipo eléctrico deber ser situado fuera del alcance de fuentes de calor como radiadores, registros de calor, estufas u otros aparatos (incluyendo amplificadores) que producen calor.
11. El aparato eléctrico deberá ser conectado a una fuente de poder sólo del tipo descrito en el instructivo de operación, o como se indique en el aparato.
12. Precaución debe ser tomada de tal manera que la tierra física y la polarización del equipo no sea eliminada.
13. Los cables de la fuente de poder deben ser guiados de tal manera que no sean pisados ni pellizcados por objetos colocados sobre o contra ellos, poniendo particular atención a los contactos y receptáculos donde salen del aparato.
14. El equipo eléctrico debe ser limpiado únicamente de acuerdo a las recomendaciones del fabricante.
15. En caso de existir, una antena externa deberá ser localizada lejos de las líneas de energía.
16. El cable de corriente deberá ser desconectado del cuando el equipo no sea usado por un largo periodo de tiempo.
17. Cuidado debe ser tomado de tal manera que objetos líquidos no sean derramados sobre la cubierta u orificios de ventilación.
18. Servicio por personal calificado deberá ser provisto cuando:
 - A: El cable de poder o el contacto ha sido dañado; u
 - B: Objetos han caído o líquido ha sido derramado dentro del aparato; o
 - C: El aparato ha sido expuesto a la lluvia; o
 - D: El aparato parece no operar normalmente o muestra un cambio en su desempeño; o
 - E: El aparato ha sido tirado o su cubierta ha sido dañada.

Contents

1. Specifications 6

 1.1 Options 6

2. Welcome 7

 2.1 Access permissions 8

 2.2 Port designations 8

3. Installation 10

 3.1 Connections 10

 3.1.1 Computer connections: Video 10

 3.1.2 Computer connections: USB 11

 3.1.3 Computer connections: Data link 11

 3.1.4 Switch (DCX1000) connections: Computer links 12

 3.1.5 Reallocating ports 12

 3.1.6 Switch (DCX1000) connections: User console links 12

 3.1.7 Switch (DCX3000) connections: Computer links 13

 3.1.8 Reallocating ports 13

 3.1.9 Switch (DCX3000) connections: User console links 13

 3.1.10 Switch connections: Network link 14

 3.1.11 Switch connections: Serial options port 14

 3.1.12 Switch connections: Power 15

 3.1.13 Console connections: Video 16

 3.1.14 Console connections: USB 17

 3.1.15 Console connections: Audio 17

 3.1.16 Console connections: Data link 18

 3.1.17 Console connections: Options port 18

 3.1.18 Console connections: Power 19

4. Configuration 20

 4.1. Accessing DCX Matrix 20

 4.2 Using DCX Matrix 22

 4.3 Quick guide to creating a new installation 23

 4.4 The Control page 24

 4.5 The Configure pages 25

 4.6 Configure > Consoles 29

 4.7 Configure > Consoles > Remotes 33

 4.8 Configure > Computers 35

 4.9 Configure > Computers > Locals 38

 4.10 Reallocating ports 40

 4.11 The Users page 41

 4.12 The Maintenance pages 42

 4.13 Resetting and recovering 45

5. Operation 47

 5.1 Viewing the OSD 47

 5.2 Choosing a computer 48

 5.3 Using Audio 49

 5.4 Indicators 50

Appendix A. Safety Information 52

Appendix B. Firmware upgrades for basic extender installations 53

Appendix C. Link cable interference protection 54

1. Specifications

Approvals: CE, FCC

Hardware Compatibility: All computers with DVI-D/DisplayPort digital video and USB interfaces

Software Compatibility: Operates with all known software and operating systems including Windows®, Linux®, Unix®, BSD, all Sun® OS, all Mac® OS, NetWare®, etc.

Operating Temperature: 32 to 104°F (0 to 40°C)

1.1 Options

The following options are available for your DCX installation:

- DCX1000 digital matrix switch with 10 ports Part number: DCX1000-IEC
- DCX3000 digital matrix switch with 30 ports Part number: DCX3000-IEC
- DCX SAM module with DisplayPort video and USB connections Part number: DCX3000-DPT
- DCX SAM module with DVI-D video and USB connections Part number: DCX3000-DVT
- DCX SAM module with VGA video and USB connections Part number: DCX-VGA
- DCX DVR remote console module Part number: DCX3000-DVR-IEC
- 19" rack mount bracket for two DCX-DVR remote console modules Part number: DCX3000-DVR-RMK

2. Welcome

Thank you for choosing the Black Box DCX system. This adaptive system makes sharing numerous host computers among multiple users straightforward and flexible. Every computer is linked, via its USB and video ports, to a compact DCX SAM module while each set of peripherals are connected to a DVR Remote module (to form *Consoles*).

The various computers and consoles are then linked, via **CAT6a** or **CAT7** cable with **S/FTP**, **S/STP** or **PiMF shielding** (see [Appendix C](#) for details), to a central DCX switch. Each user can then, subject to the privileges granted by the admin, gain quick access to any of the required computers.

An integral part of the DCX1000 and DCX3000 Switches is the DCX Matrix, a browser-based configuration and management tool that allows one or more remote admin user(s) to monitor and maintain all aspects of operation.

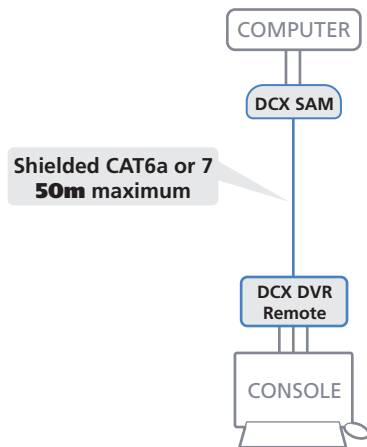
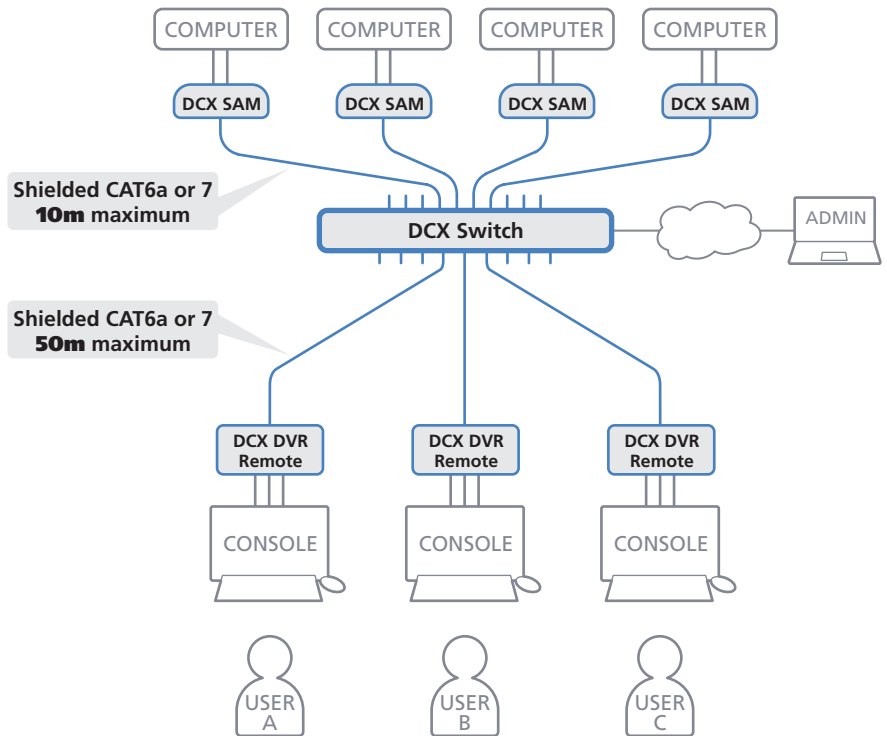

If required, computers and consoles can be individually connected in order to take advantage of the DCX extender properties without the switching.

IMPORTANT: Always ensure you are using shielded cables with DCX modules.

Cable type and distance rules

- Cable screening/shielding is required. The best cable shielding specifications for use with the DCX system are: S/FTP, S/STP or PiMF.
- Extension distances up to 50m are supported with single uninterrupted runs of recommended cable (shielded CAT6a or CAT7 cable).
- CAT5 or CAT5e cables must not be used with this product.
- Overall cable runs must be reduced by 5m for each additional cable coupling.
- All patch cables should be as short as possible and should be no longer than 2m.
- It is recommended that shielded CAT7 cables are used for maximum performance.

2.1 Access permissions

The DCX1000 and DCX3000 Switches use a system of hierarchal Access permissions to mediate between numerous consoles and multiple computers. Each console is granted the use of up to four types of access permissions to each computer, most of which influence how other users can gain simultaneous access to the same computer. The four access permissions, and their effects on other console users are as follows:



VIEW ONLY

The console user can view the chosen computer's output but cannot alter it.

Once selected, other consoles can simultaneously use VIEW ONLY, SHARED ACCESS or EXCLUSIVE for the same computer.



SHARED ACCESS

The console user can view and control the chosen computer's output.

Once selected, other consoles can simultaneously use VIEW ONLY or SHARED ACCESS for the same computer.



EXCLUSIVE

The console user can view and control the chosen computer's output.

Once selected, other consoles can simultaneously use VIEW ONLY for the same computer.



PRIVATE

The console user can view and control the chosen computer's output.

Once selected, all other consoles are completely locked out from the same computer.

Note: The hierarchy of permissions shown here increases from left to right.

2.2 Port designations

2.2.1 DCX1000

By default the DCX1000 Switch provides 8 computer ports (1 to 8) and 2 user console ports (9 to 10), all on its rear panel, however, these designations are not fixed. If your installation requires a greater number of consoles, you can alter the allocation of these standard ports to suit:

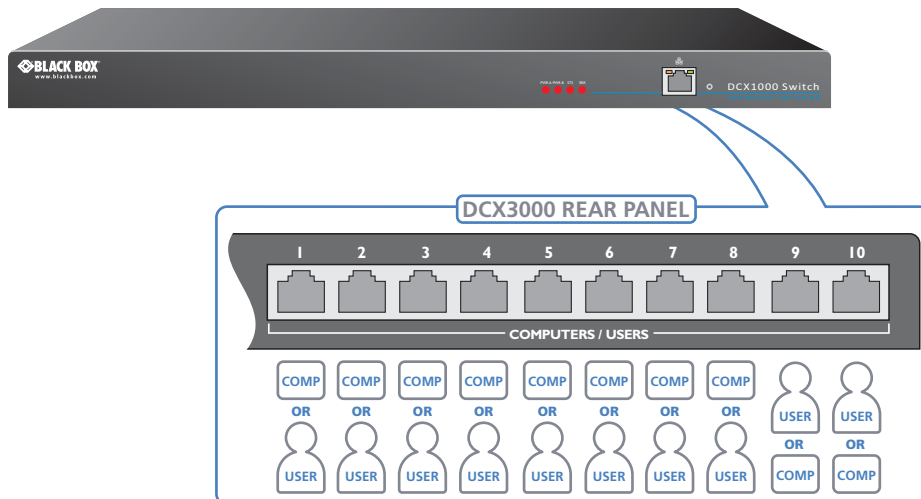

2.2.2 Port designations

By default the DCX3000 Switch provides 10 user console ports on its front panel and 20 computer ports along its rear panel, however, these designations are not fixed. If your installation requires a greater number of computers or has a need for more user consoles, you can alter the allocation of these standard ports to suit:

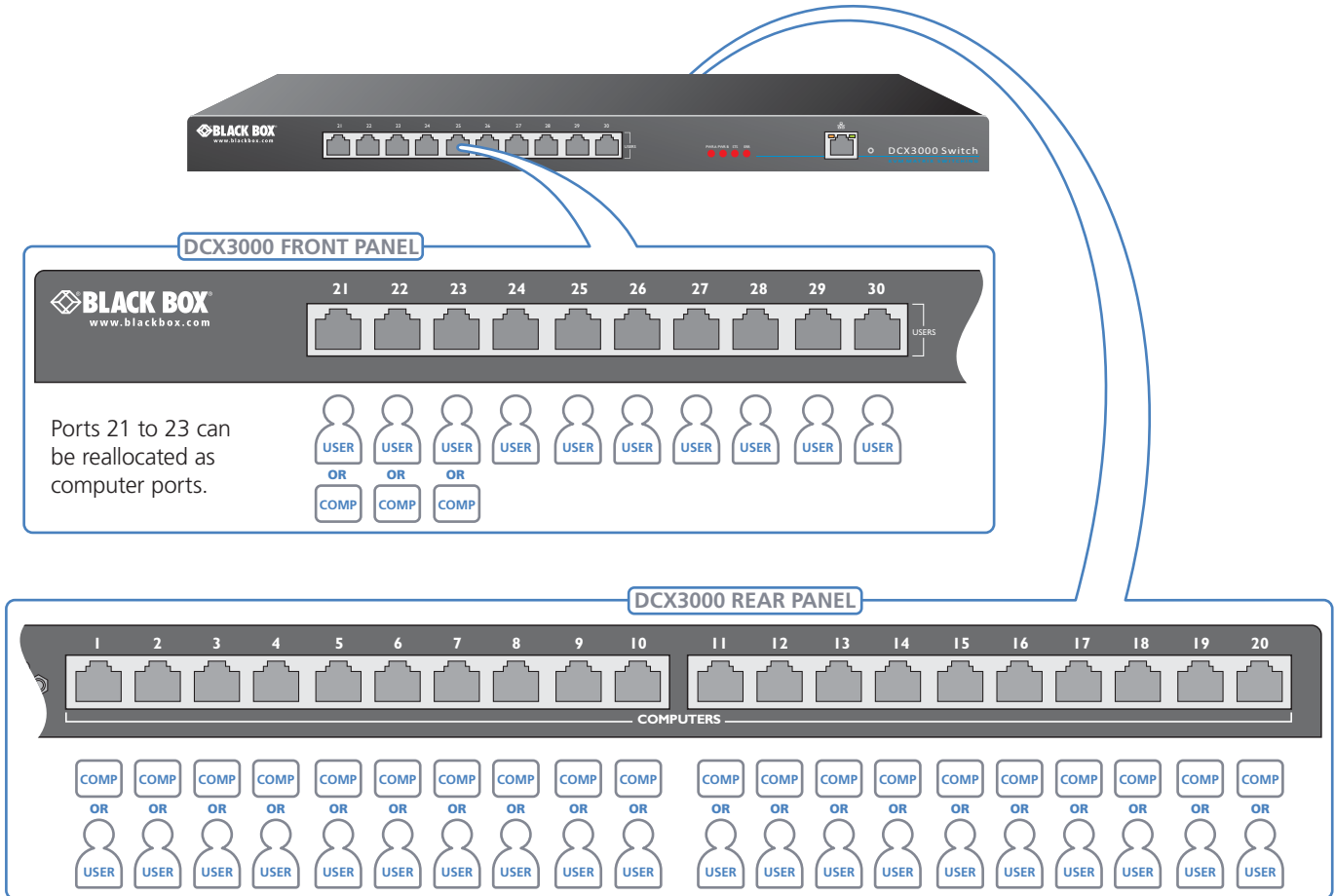

Any of the 20 rear panel computer ports can be reallocated as user console ports

3. Installation

Please consider the following important points when planning the position of the DCX modules:

- If used, position the DCX1000/3000 Switch in a central position that serves the host systems and user modules without exceeding the maximum link lengths. It will also require a source of mains power.
- Situate each DCX-DVR remote module close to the peripherals to which it will be connected and near to a source of mains power.
- Consult the precautions listed within the Safety information section.

3.1 Connections

Connections do not need to be carried out in the order given within this guide, however, where possible connect the power in as a final step. Connections are split into the following three areas:

- **Computer connections** - a DCX SAM module (two versions available) links to each computer.
- **Switch connections** - when used, a DCX1000 or DCX3000 Switch unit sits at the heart of the system.
- **Console connections** - the peripherals (keyboard, display, etc.) connect to DCX-DVR remote modules.

3.1.1 Computer connections: Video

Three types of DCX SAM modules are available:

- DVI-D and USB,
- or
- DisplayPort and USB.

If a computer has more than one video output, use additional DCX SAM modules to separately link the alternative video stream(s) with other ports on the DCX1000/3000 Switch.

3.1.1.1 To connect the video port

1 Connect the video lead of the DCX SAM (*DPT* for DisplayPort, *DVT* for DVI-D or *VGA* for VGA) video port of the host computer.

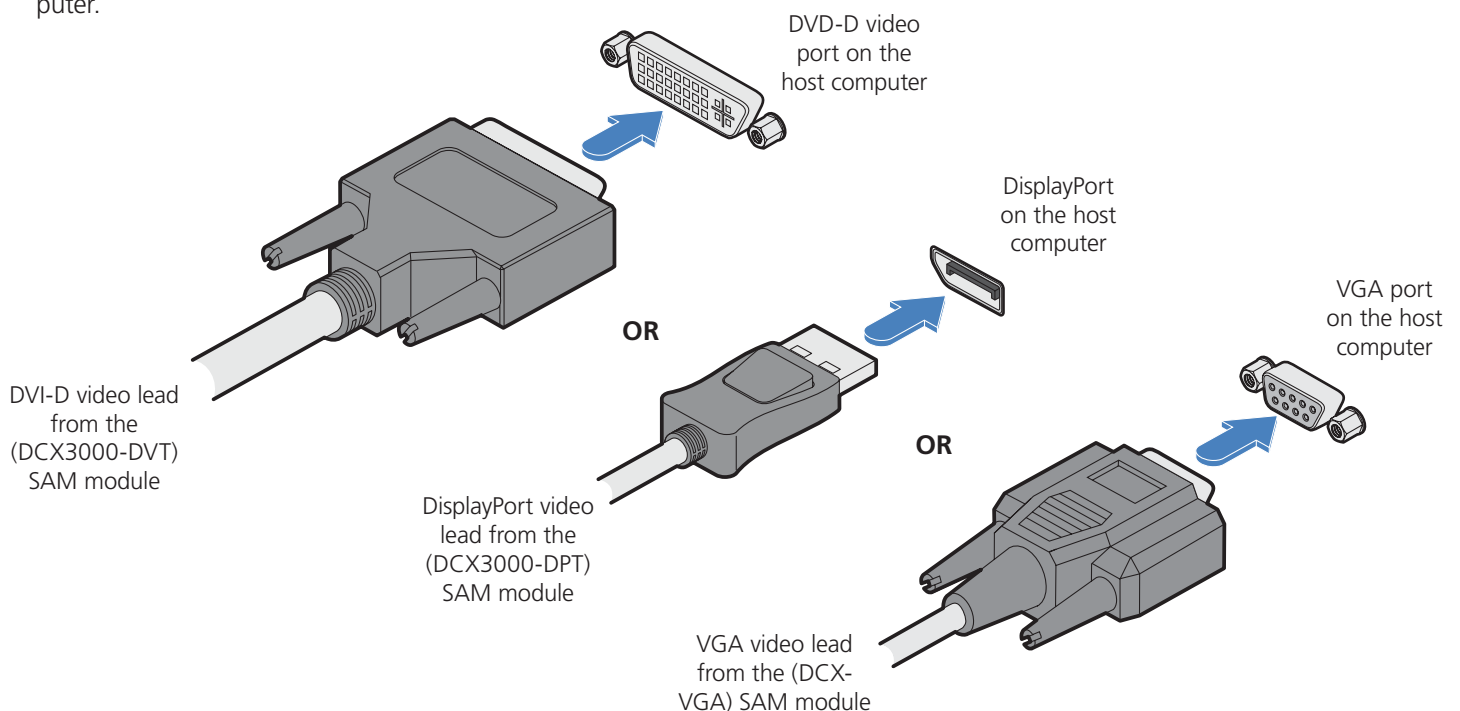

3.1.2 Computer connections: USB

Each DCX SAM module requires a single USB connection to the computer. This provides essential power for the DCX SAM module in addition to the USB signals. Each DCX-DVR module acts as a USB 2.0 hub and thus provides four sockets for peripherals.

3.1.2.1 To connect the USB port

- 1 Connect the USB cable of the DCX SAM module to a vacant USB socket on your host computer.

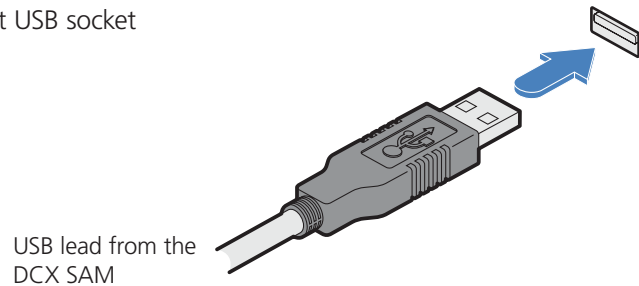

3.1.3 Computer connections: Data link

Each DCX SAM module is linked via a shielded (S/FTP or S/STP) CAT6a or CAT7 cable either to a central DCX Switch module (multi-system matrix installation) or directly to a DCX-DVR module (single system installation).

For best results use CAT7 cables to link all DCX SAM modules. Maximum cable lengths:

- DCX SAM to DCX Switch - 32 feet (10m) maximum.
- DCX SAM to DCX-DVR - 164 feet (50m) maximum.

3.1.2.2 To link the DCX SAM module

- 1 Connect the RJ-45 plug of the link cable to the socket located at the end of the DCX SAM module.

IMPORTANT: Always ensure you are using shielded cables with DCX modules.

Shielded CAT6a or CAT7 link from DCX Switch or DCX-DVR module

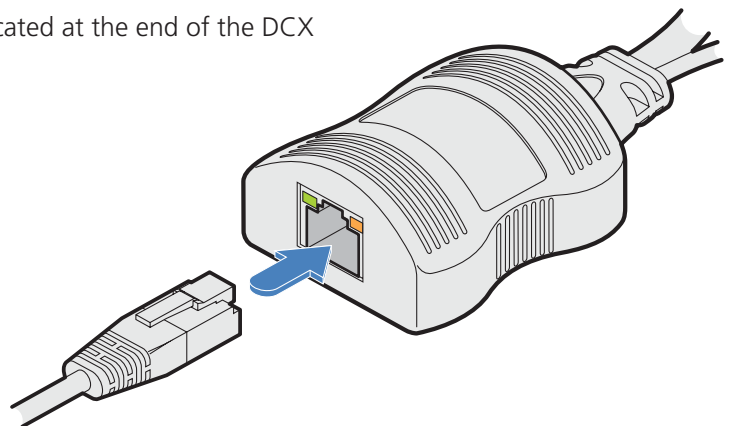

3.1.4 Switch (DCX1000) connections: Computer links

The host computer links are made to the sockets on the rear panel of the DCX1000 switch.

3.1.4.1 To connect a host link

- 1 Connect the shielded (S/FTP or S/STP) CAT6a or CAT7 cable from the remote DCX SAM host module to a vacant RJ-45 socket on the rear panel of the DCX Switch.

 These are NOT Ethernet/network ports and must NEVER be connected to any networking equipment.

Shielded CAT6a or CAT7 link from a DCX SAM host module

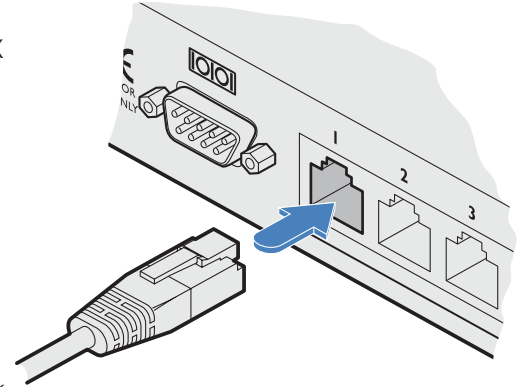

IMPORTANT: Always ensure you are using shielded cables with DCX modules.

3.1.5 Reallocating ports

The user console links are made via the sockets on the rear panel of the DCX1000 Switch provides 8 computer ports and 2 user ports along its rear panel. If necessary, these standard arrangements can be changed. See [Reallocating ports](#).

3.1.6 Switch (DCX1000) connections: User console links

The user console links are made via the sockets on the rear panel of the DCX1000.

3.1.6.1 To connect a console link

- 1 Connect the shielded (S/FTP or S/STP) CAT6a or CAT7 cable from the remote DCX-DVR module to a vacant RJ-45 socket (sockets 9 and 10, by default) on the rear panel of the DCX1000 Switch.

Shielded CAT6a or CAT7 link from a DCX-DVR module

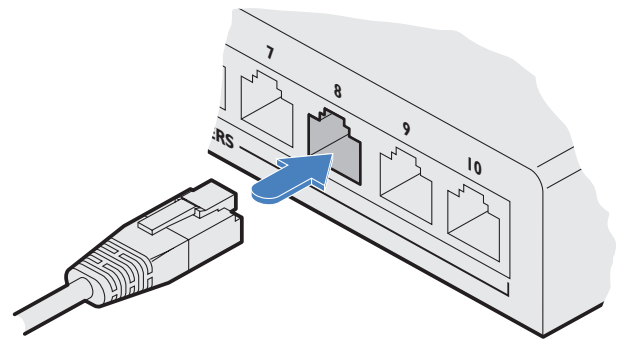

 These are NOT Ethernet/network ports and must NEVER be connected to any networking equipment.

IMPORTANT: Always ensure you are using shielded cables with DCX modules.

3.1.7 Switch (DCX3000) connections: Computer links

The host computer links are made to the sockets on the rear panel of the DCX3000 switch.

3.1.7.1 To connect a host link

- 1 Connect the shielded (S/FTP or S/STP) CAT6a or CAT7 cable from the remote DCX SAM host module to a vacant RJ-45 socket on the rear panel of the DCX Switch.

 These are NOT Ethernet/network ports and must NEVER be connected to any networking equipment.

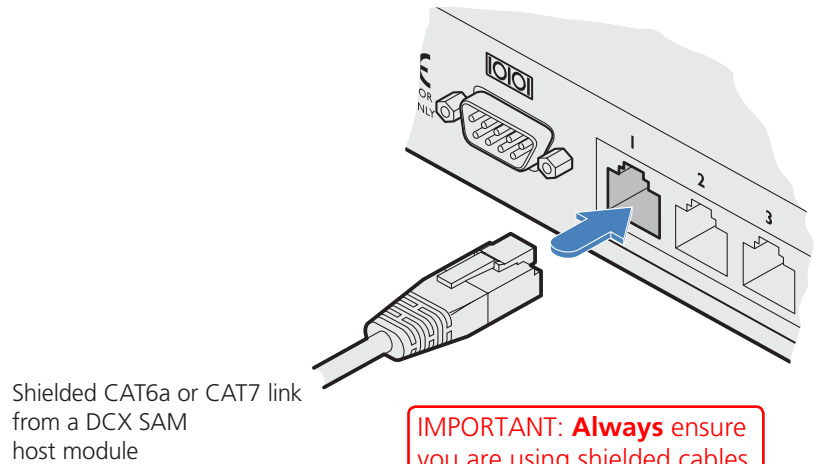

IMPORTANT: Always ensure you are using shielded cables with DCX modules.

3.1.8 Reallocating ports

By default the DCX3000 Switch provides 20 computer ports along its rear panel and 10 user ports along its front panel. If necessary, these standard arrangements can be changed. See [Reallocating ports](#).

3.1.9 Switch (DCX3000) connections: User console links

The user data links are generally made via the sockets at the front of the switch, although any of the rear panel sockets can also be converted to user ports (see above).

3.1.9.1 To connect a console link

- 1 Connect the shielded (S/FTP or S/STP) CAT6a or CAT7 cable from the remote DCX-DVR module to a vacant RJ-45 socket on the front panel of the DCX3000 Switch.

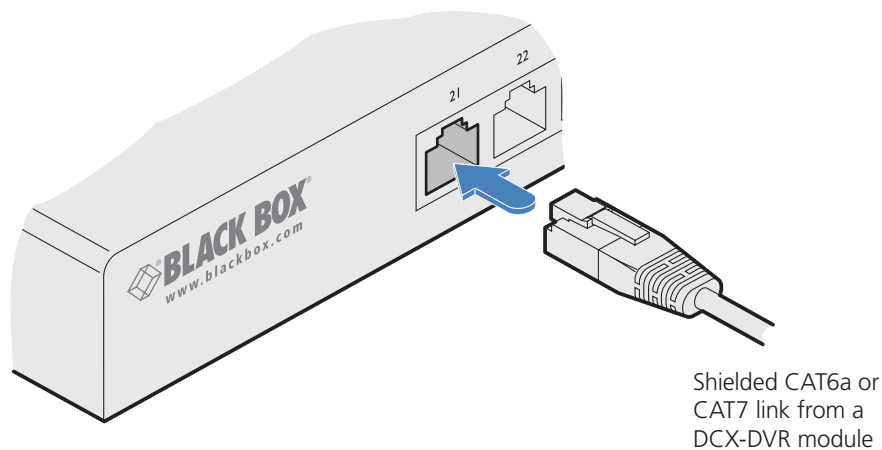

 These are NOT Ethernet/network ports and must NEVER be connected to any networking equipment.

IMPORTANT: Always ensure you are using shielded cables with DCX modules.

3.1.10 Switch connections: Network link

All system configuration is carried out via an Ethernet link, allowing adjustments to be made by authorized admin users located next to the DCX1000/3000 unit, or anywhere. The auto-sensing network port can determine between 10, 100Mbps or 1Gbps links and can also adjust to straight or cross-over cables.

3.1.10.1 To connect a network link

- 1 Connect the CATx cable from the nearest Ethernet switch or from a local computer.

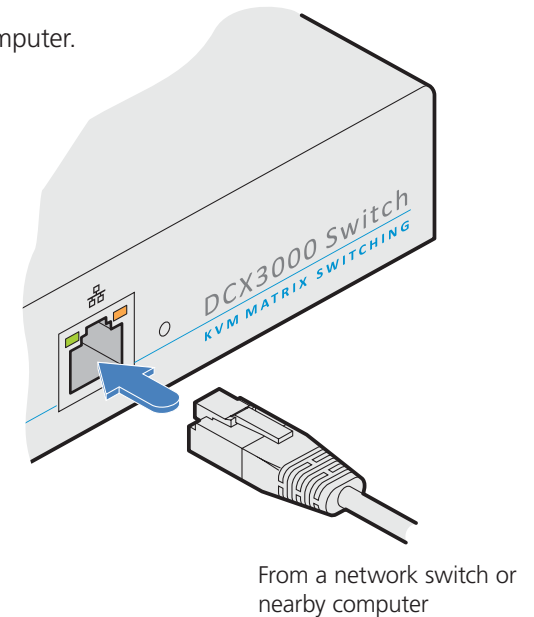

3.1.11 Switch connections: Serial options port

The options port is reserved for future use.

3.1.12 Switch connections: Power

Each DCX1000/3000 Switch is supplied with a single power adapter but offers the facility to use a second input in order to provide operational redundancy. The switch unit can operate perfectly well from a single power adapter operating alone. When two adapters are connected, the unit will spread its load between them; should one power input fail, 100% of the load will be transferred to the other power adapter without a break in operation. Remote checking of the power inputs is possible at any time via the Maintenance page of the browser interface.

There is no on/off switch on DCX1000/3000 units, so operation begins as soon as power is applied at either port.

3.1.12.1 To connect the power adapter

- 1 Attach the output plug of the supplied power adapter to either power input socket on the left side of the rear panel.

IMPORTANT: Please read and adhere to the electrical safety information given within the Safety information section of this guide. In particular, do not use an unearthed power socket or extension cable.

Note: Both the modules and the power supplies generate heat when in operation and will become warm to the touch. Do not enclose them or place them in locations where air cannot circulate to cool the equipment. Do not operate the equipment in ambient temperatures exceeding 40 degrees Centigrade. Do not place the products in contact with equipment whose surface temperature exceeds 40 degrees Centigrade.

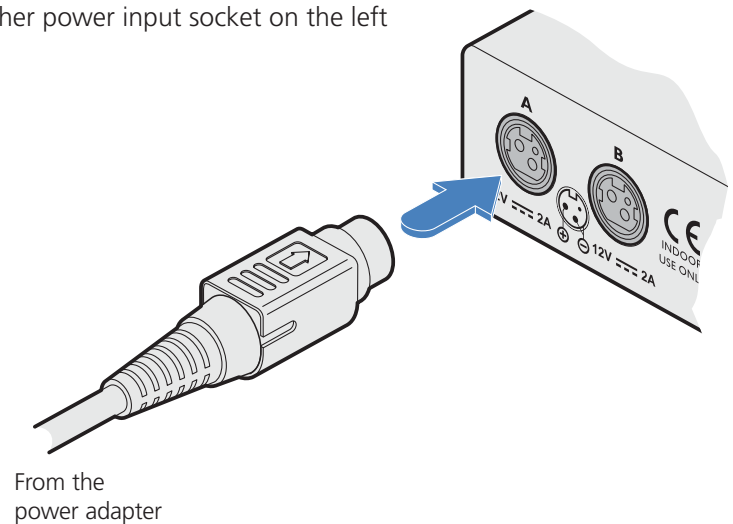

- 2 Connect the IEC connector of the supplied country-specific power cord to the socket of the power adapter.
- 3 Connect the power cord to a nearby main supply socket.
- 4 Where power redundancy is required, repeat steps 1 to 3 for a second power adapter.

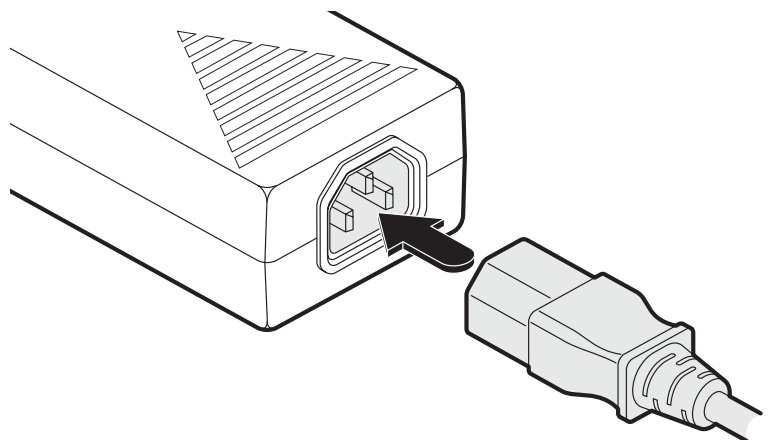

3.1.12.2 To disconnect the power adapter

- 1 Isolate the power adapter from the mains supply.

Note: If you are replacing one of dual power adapters during operation, it is not necessary to also remove power from the other adapter.

- 2 Grasp the outer body of the power adapter plug where it connects with the module.
- 3 Gently pull the body of the outer plug away from the module. As the body of the plug slides back, it will release from the socket and you can fully withdraw the whole plug.

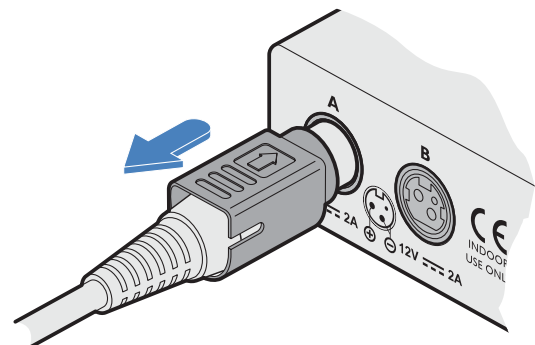

Gently pull back the plug outer body to release the lock

3.1.13 Console connections: Video

A Single Link DVI-D port is provided on the rear panel of the user module.

The DCX-DVR module supports one video display with pixel clocks up to 165MHz (equivalent to a maximum resolution of 1920 x 1200 at 60Hz - aka 'WUXGA').

If a second display is required to support a dual video installation, use another DCX-DVR module to drive the second display, and combine the two user modules into a single Console within the DCX Matrix configuration application.

3.1.13.1 To connect the video display

- 1 Connect the DVI-D video cable from your video display to the video output port on the rear panel of the user module.

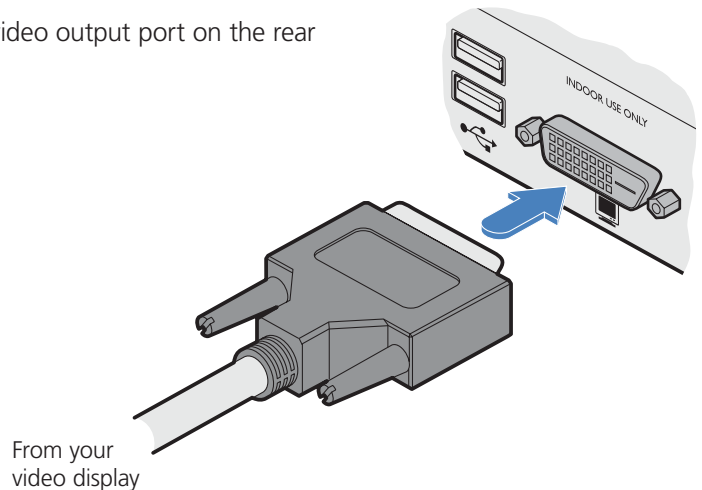

3.1.13.2 EDID management

The DCX1000/3000 Switches provide a number of fixed EDID (Extended Display Identification Data) profiles that will suit a large number of video display configurations. If additional EDID definitions are required for your installation, you can clone new definitions from connected video displays and add these to the list of available definitions.

For details about cloning EDIDs from displays, see [Add EDID](#).

For details about applying an EDID to a particular computer, see [Configure > Computers > Locals](#).

3.1.13.3 DCX-DVR module switches

The two switches on the DCX-DVR module are reserved for future use and must both remain in the OFF position.

3.1.14 Console connections: USB

The DCX-DVR module contains a USB hub that can support up to four v1.1 or v2.0 USB devices (in any combination). All four USB sockets, two on the front panel and two on the rear, are identical in operation.

Note: In multi-head installations, the USB devices must be attached only to the DCX-DVR that drives the main display.

3.1.14.1 To connect USB devices

- 1 Connect your USB keyboard and mouse to any of the four sockets distributed on the front and rear panels of the user module.

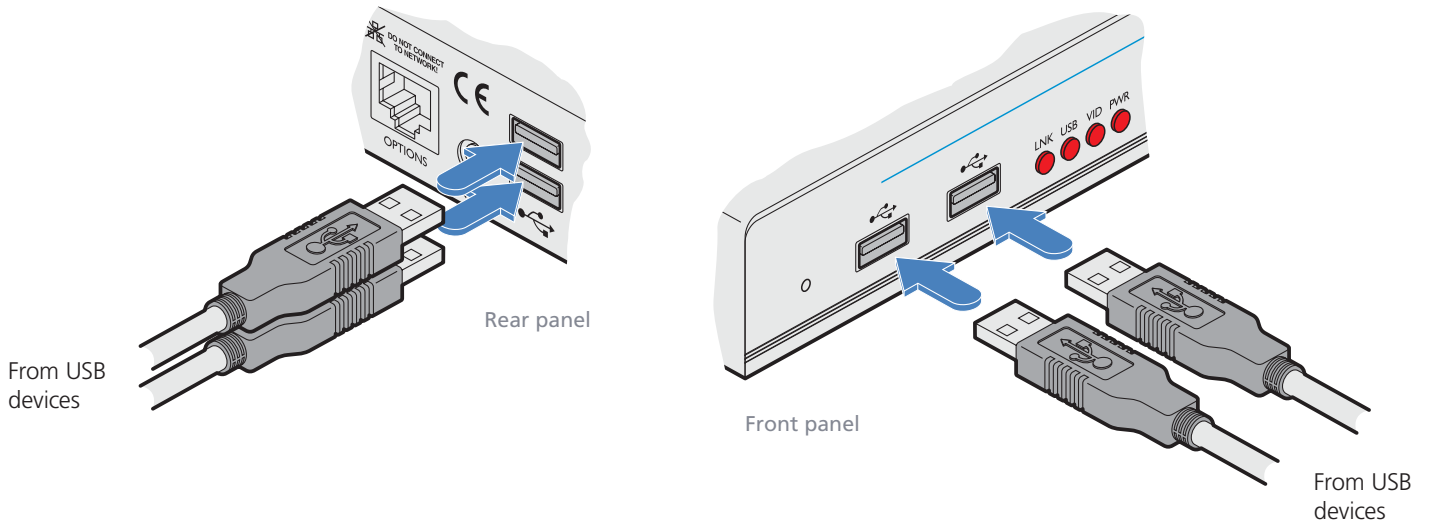

3.1.15 Console connections: Audio

The DCX-DVR module supports stereo speakers, headphones and also a microphone port. All audio devices are presented at the linked host computer as USB audio devices.



Note: In multi-head installations, the audio devices must be attached only to the DCX-DVR that drives the main display.

3.1.15.1 To connect your speakers

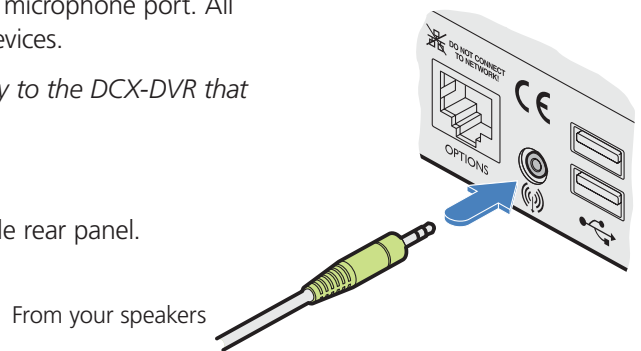
- 1 Connect your speakers to the audio line out socket on the user module rear panel.



3.1.15.2 To connect your headphones/microphone

- 1 Connect your headphones to the socket labeled  on the user module front panel.
- 2 Connect your microphone to the socket labeled  on the user module front panel.

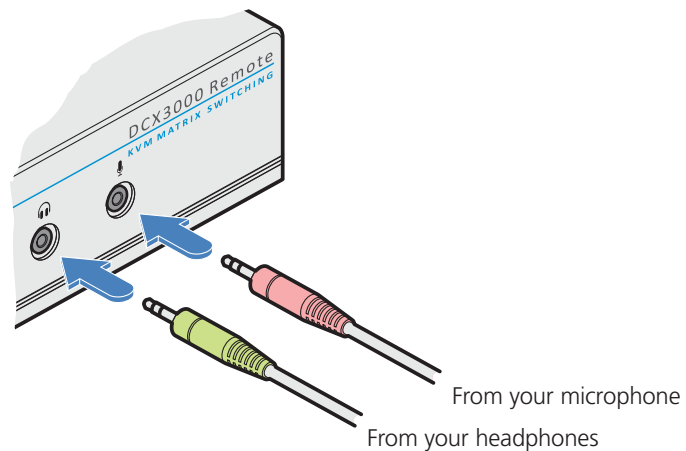

3.1.16 Console connections: Data link

Each DCX-DVR module is linked via a shielded (S/FTP or S/STP) CAT6a or CAT7 cable either to a central DCX1000/3000 Switch module (multi-system matrix installation) or directly to a DCX SAM module (single system installation).

For best results use shielded (S/FTP or S/STP) CAT6a or CAT7 cables to link all DCX SAM modules - do not exceed 50 meters (164 feet).

3.1.16.1 To link the DCX-DVR module

1 Connect a suitable shielded (S/FTP or S/STP) CAT6a or CAT7 cable to the LINK socket on the rear panel of the DCX-DVR module. Connect the other end of the cable to either a DCX1000/3000 Switch or directly to a DCX SAM host module.

 This is NOT an Ethernet/network port and must NEVER be connected to any networking equipment.

Shielded CAT6a or CAT7 link from DCX1000/3000 Switch or DCX SAM

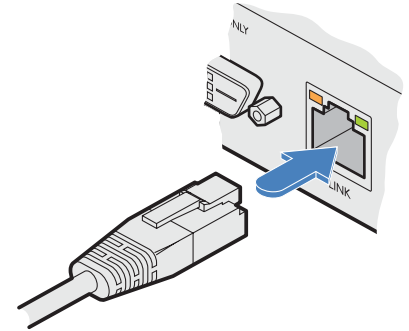

IMPORTANT: Always ensure you are using shielded cables with DCX modules.

3.1.17 Console connections: Options port

The options port is reserved for future use.

3.1.18 Console connections: Power

There is no on/off switch on the DCX-DVR module, so operation begins as soon as power is applied. The supplied power adapter uses a locking-type plug to help prevent accidental disconnections; please follow the instructions given right whenever disconnecting a power adapter.

3.1.18.1 To connect the power adapter

- 1 Attach the output plug of the supplied power adapter to either power input socket on the rear panel of the DCX-DVR module.

IMPORTANT: Please read and adhere to the electrical safety information given within the Safety information section of this guide. In particular, do not use an unearthed power socket or extension cable.

Note: Both the modules and the power supplies generate heat when in operation and will become warm to the touch. Do not enclose them or place them in locations where air cannot circulate to cool the equipment. Do not operate the equipment in ambient temperatures exceeding 40 degrees Centigrade. Do not place the products in contact with equipment whose surface temperature exceeds 40 degrees Centigrade.

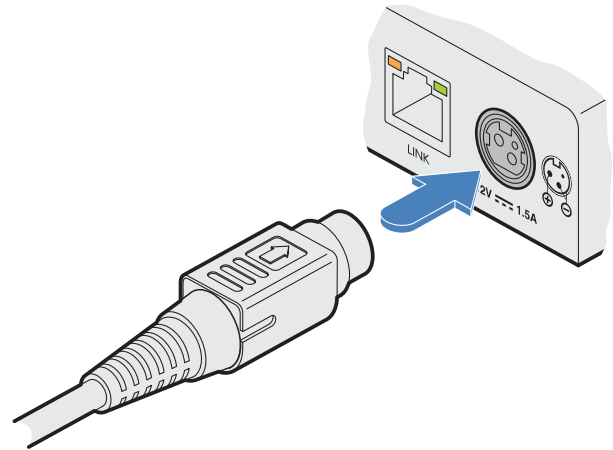

From the power adapter

- 2 Connect the IEC connector of the supplied country-specific power cord to the socket of the power adapter.
- 3 Connect the power cord to a nearby main supply socket.
- 4 Where power redundancy is required, repeat steps 1 to 3 for a second power adapter.

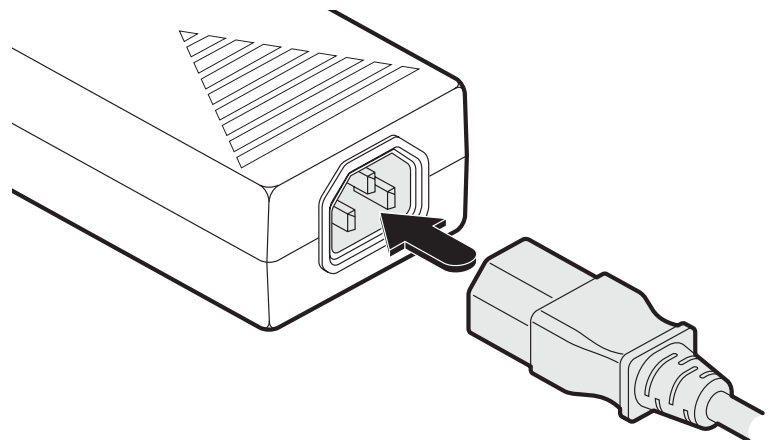

3.1.18.2 To disconnect the power adapter

- 1 Isolate the power adapter from the mains supply.
- 2 Grasp the outer body of the power adapter plug where it connects with the module.
- 3 Gently pull the body of the outer plug away from the module. As the body of the plug slides back, it will release from the socket and you can fully withdraw the whole plug.

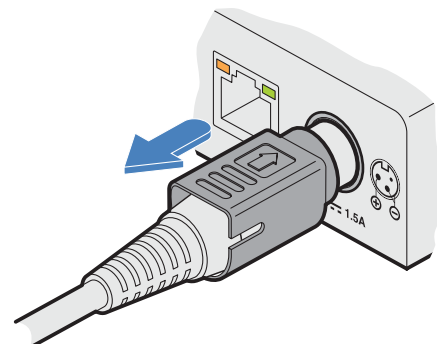

Gently pull back the plug outer body to release the lock

4. Configuration

4.1. Accessing DCX Matrix

DCX1000/3000 Switches are configured via their network connections using an intuitive browser-based application, called DCX Matrix. This secure, password protected application is accessible by any authorized admin user, located anywhere. The DCX1000/3000 switch can also be accessed via cross origin resource sharing (CORS). This allows interaction in a browser from a different web application. The API is served in a YAML format which can be found at `http(s)://<ipaddress>/rest-api`. The switch adheres to RESTful and CORS standards.

4.1.1 To access DCX Matrix

- 1 Use a computer that is directly or indirectly (i.e. via a network switch) connected to the Switch. If you need to make a temporary connection, see next page.
- 2 Run a web browser on your computer and enter the IP address of the DCX1000/3000 Switch. The switch will attempt to contact a valid DHCP server to determine a suitable IP address. If a DHCP server cannot be located then the switch will automatically fall back to a link-local IP address (in the range 169.254.1.0 thru 169.254.254.255).

Whichever method the switch uses, the initial IP address can be discovered either:

- Using the Windows network browser (of a computer connected to the same sub network or directly to the switch), or
- In the lower right corner of the OSD screen (of a console connected to one of the user ports) see Viewing the OSD.

Note: For security, DCX Matrix uses HTTPS by default with a self-signed certificate - Please ignore any warnings that may be displayed by your web browser.

- 3 If requested, enter your username and password to log on.

*Note: The default username and password are **admin** and **password** respectively.*

The opening page of the DCX Matrix should be displayed:

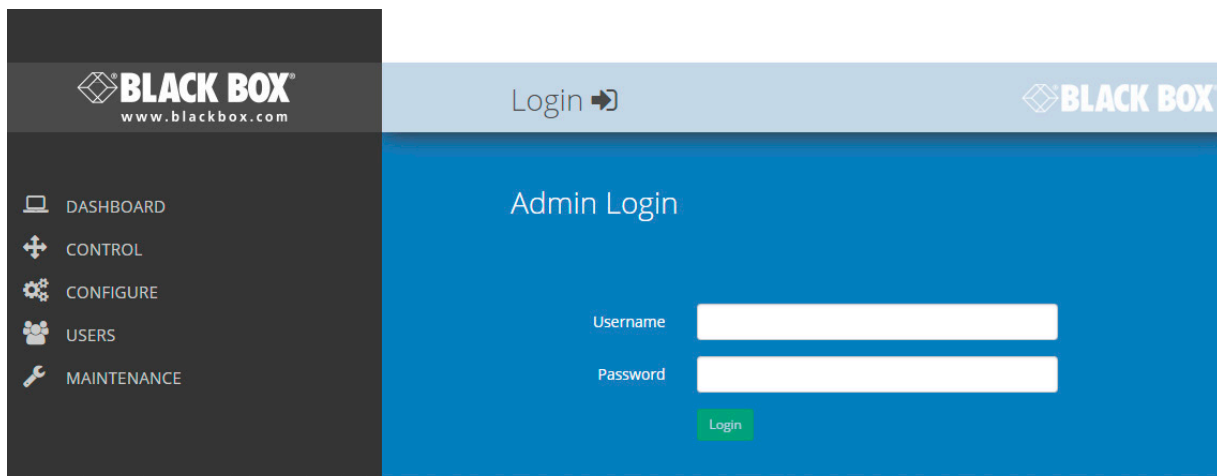

4.1.2 To temporarily connect a computer to the network port

- 1 If you need to make a temporary connection for configuration purposes, use a standard patch cable (cross-over or straight connections are both supported) to link the Ethernet 10/100 network port (🔌) on the front panel of the DCX3000 Switch to your computer's network port.

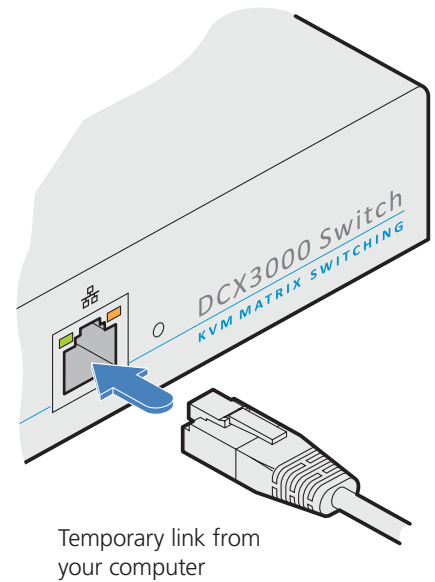

4.2 Using DCX Matrix

4.2.1 The Dashboard page

Once you have successfully logged in, DCX Matrix will show the dashboard page to provide a general overview of your DCX installation. You can also re-display this page by clicking the Dashboard entry in the menu:

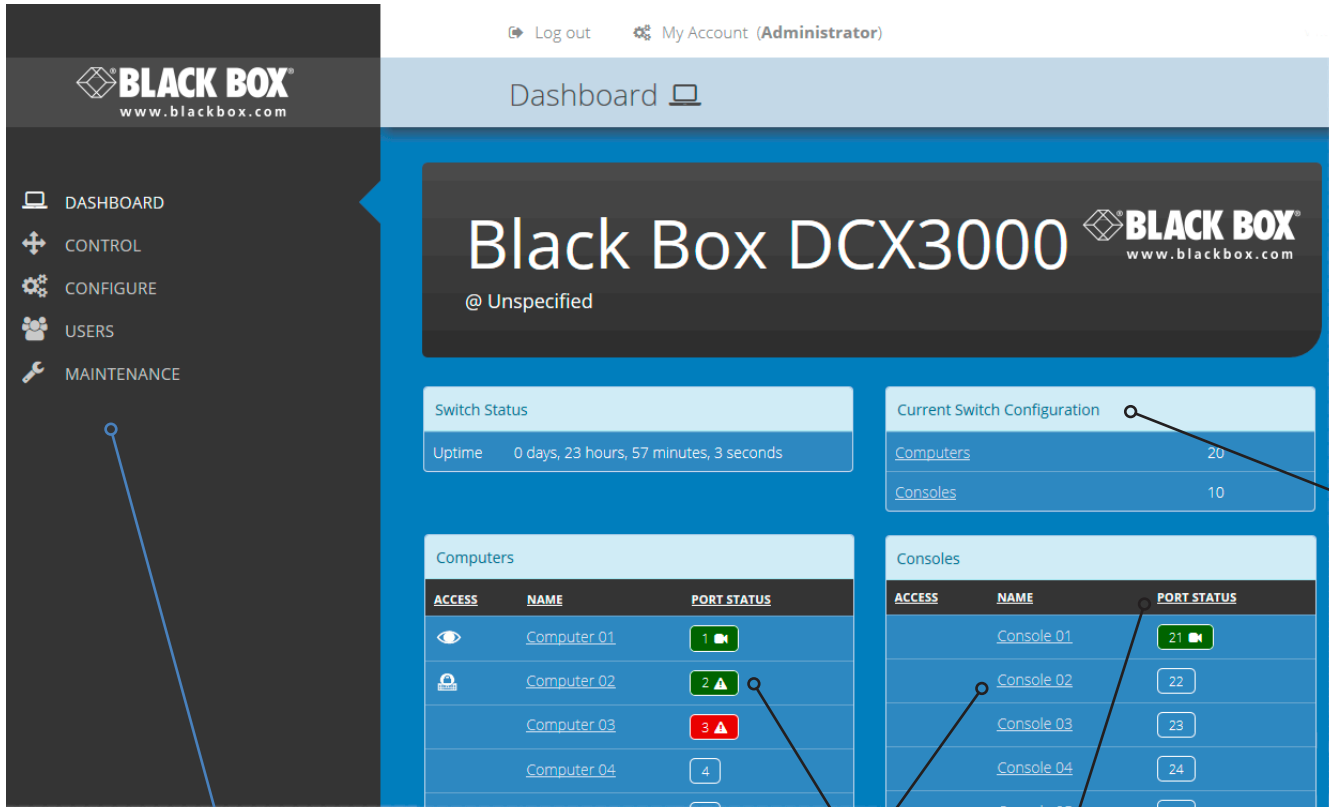

Click the required menu item to reveal the available page choices.

Colors and symbols are used to provide quick visual feedback:

- Operational with a valid video signal
- Operational but firmware upgrade suggested
- Not useable, firmware upgrade required
- Disconnected

Note: An icon showing orange is currently being upgraded

Hover your mouse over an icon to see more information:

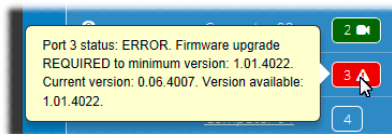

Click a heading to reorder the whole list in ascending or descending order according to the entries within the chosen column.

Information and options are displayed within the main section of the page. Some items will provide further popup information when you hover your mouse pointer over them.

Note: It is not possible to leave DCX Matrix open for more than 24 hours.

4.3 Quick guide to creating a new installation

When creating a new DCX installation there are various tasks that need to be completed. This page provides a recommended 'to do list' of the stages that you need to perform.

4.3.1 Primary tasks

- Configure the networking details for the DCX1000/3000 Switch See [Configure > Central Switch > Network](#)
- Ensure that the EDID definitions are appropriate for your installation See [Configure > Central Switch > Manage EDIDs](#)
 - If additional EDID definitions are required for your installation, you can clone new definitions from connected video displays and add these to the list of available definitions* See [Add EDID](#)
- Add the required consoles (either before or after they are connected) See [Configure > Consoles](#)
 - By default the DCX3000 Switch provides 20 computer ports along its rear panel and 10 user ports along its front panel (the DCX1000 provides 8 computer ports and 2 user ports). If necessary, these standard arrangements can be changed to suit your installation* See [Reallocating ports](#)
- Determine the access permissions for each console See [Access permissions](#)
- Add your computers (either before or after they are connected) See [Configure > Computers](#)
- Add the users and define their login details See [The Users Page](#)

4.3.2 Secondary tasks

- Optionally make changes to the OSD settings See [Configure > Central Switch > OSD Settings](#)
- Add description and location details for the switch See [Configure > Central Switch > General](#)

4.4 The Control page

The Control page provides a Connection map that allows the admin user to view and affect how consoles are connected to the various computers. This page is particularly useful when managing video-only installations.

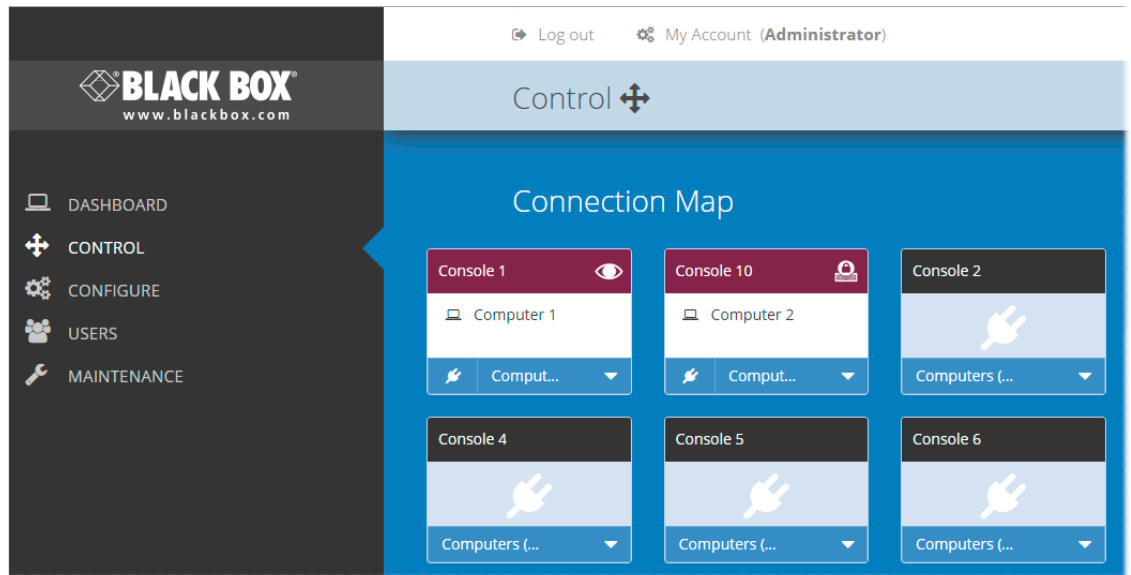

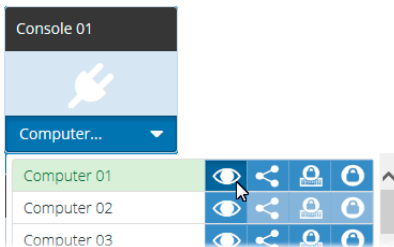

4.4.1 To connect a console

1 Click the down arrow on the console entry to reveal the list of computers that it is authorized to access.



2 Click the appropriate connection icon adjacent to the required computer:

-  **View only** - console user can view a computer's output but not alter it,
-  **Shared access** - console user can view and control a computer along with other consoles,
-  **Exclusive** - multiple console users can view a computer but only one can control it,

or

-  **Private** - console user can view and control the computer privately while other users are locked out.

For further details, see [Access permissions](#).

3 You can change the connection method at any time by clicking the down arrow again and choosing an alternative connection option.

4.4.2 To disconnect a console

1 Click the  button in the lower left corner of the console entry that you wish to disconnect.

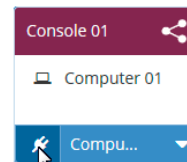

4.5 The Configure pages

The **Configure** menu option expands when clicked to reveal three sub-sections:

- Central Switch - settings related directly to the DCX1000/3000 Switch.
- [Consoles](#) - settings related to the DCX-DVR modules and their connected peripherals.
- [Computers](#) - settings related to the DCX SAM modules and their host computers.

4.5.1 Central Switch > General

Basic descriptive settings for the switch. These are most useful when multiple DCX installations are being managed and labelling each installation as you go, is a good habit to get into:

- Description - a further opportunity to add more information about the switch.
- Location - a useful feature if you have multiple DCX1000/3000 Switches distributed around.
- System Default EDID - determines the default EDID to use for the installation.
- Ignore Firmware Mismatch - when set to On, this overrides the checks that are made to ensure all modules are running compatible firmware versions. This override should be used in exceptional circumstances only.
- Firmware Version - shows the version of the switch.
- Recovery Version - shows the version of the switch recovery image.
- Admin UI Version - shows the version of the DCX Matrix admin user interface.
- Manage time automatically – when set to ON the current time and timezone will be obtained via the configured NTP & DHCP servers.
- Use Current PC Time - when managing time manually, the system time will be synced to that from the local computer.
- Timezone - when managing time manually or running without DHCP, allows you to declare which timezone you are in.

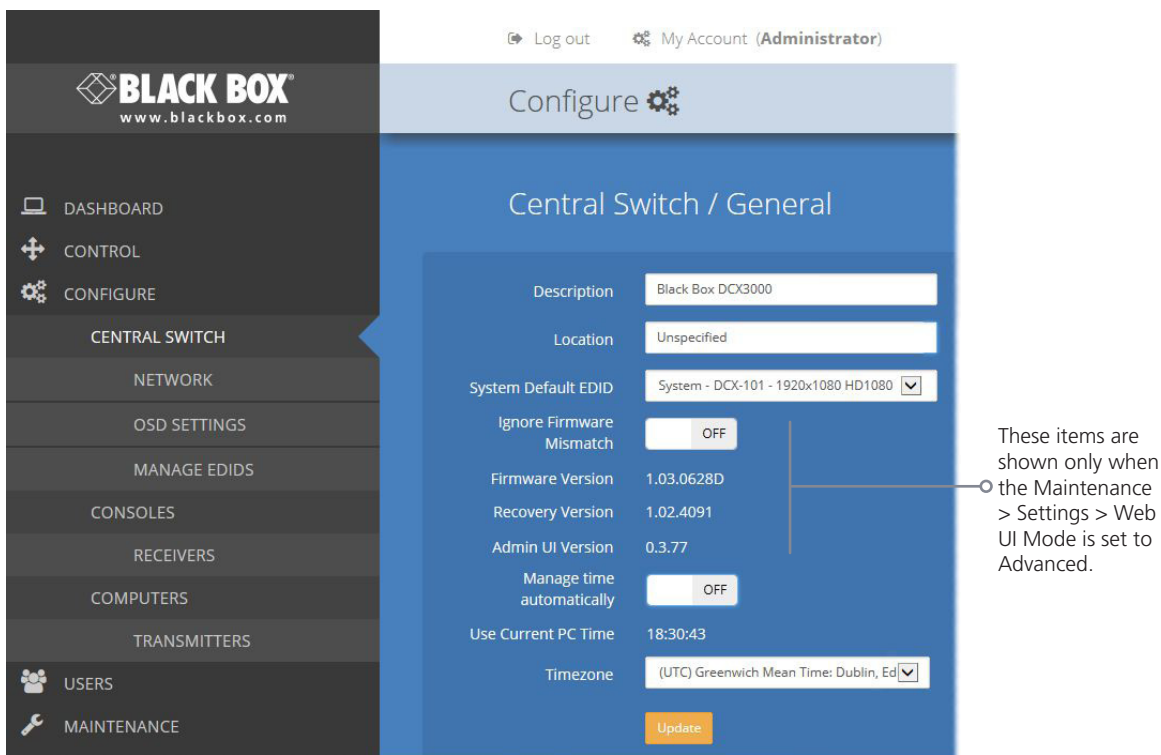

Log out My Account (Administrator)

Configure

Central Switch / General

Description: Black Box DCX3000

Location: Unspecified

System Default EDID: System - DCX-101 - 1920x1080 HD1080

Ignore Firmware Mismatch: OFF

Firmware Version: 1.03.0628D

Recovery Version: 1.02.4091

Admin UI Version: 0.3.77

Manage time automatically: OFF

Use Current PC Time: 18:30:43

Timezone: (UTC) Greenwich Mean Time: Dublin, Ed

Update

These items are shown only when the Maintenance > Settings > Web UI Mode is set to Advanced.

4.5.2 Central Switch > Network

All of the key settings for the network capabilities of the DCX1000/3000 Switch are here:

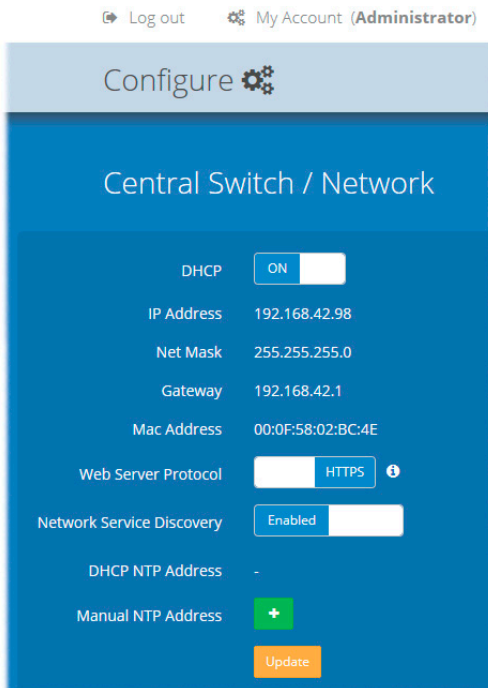

- DHCP - allows you to choose to use DHCP (Dynamic Host Configuration Protocol) to automatically determine all network settings or set them manually. When set to On, the next three options are not editable.
- IP Address - set the IP address for the switch.
- Net Mask - set a subnet mask to accompany the IP address.
- Gateway - optionally define a suitable address for a gateway device.
- MAC Address - displays the unique (and fixed) MAC address for the switch.
- Web Server Protocol - allows a change to the use of insecure HTTP for web admin - switch reboot required. IMPORTANT: Do not set this option to HTTP when the switch is connected to external networks.
- Network Service Discovery - when set to Disabled, the switch will not announce its presence on the network and will not be discoverable using the Windows network browser on a network-connected computer.
- DHCP NTP Address - when DHCP is On, this area lists the addresses of time servers being used.
- Manual NTP Address - allows you to enter the static IP addresses of up to five NTP servers (an average of the time feeds from the servers are taken).

4.5.3 Central Switch > OSD Settings

Options related to the on screen display are presented in this section:

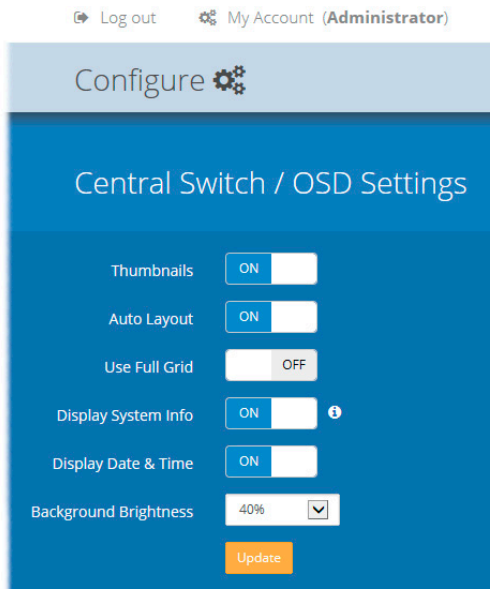

- **Thumbnails** - when set to Off, this option will hide the thumbnail views of each computer within each user's OSD main page.
- **Auto Layout** - when set to Off, this option will maintain a 5x5 grid for the displayed computers within the OSD main page, regardless of the number of available computers. When set to On, the OSD view grid will be re-scaled accordingly.
- **Use Full Grid** - when set to On, if you have 4, 9 or 16 computers connected, the OSD will use the bottom right portion of the screen as a square computer thumbnail, instead of reserving it for the system information. A small tab appears in the top right corner of the OSD if "Show System Info" is On, showing the IP address and an icon denoting any compatibility issues (green tick for no issues, yellow warning for upgrade recommended and a red warning for upgrade required).
Note: This option will be hidden if Auto Layout is set to Off.
- **Display System Info** - when set to On, the current IP address and firmware version details for the switch will be shown in the lower right corner of the OSD, or the IP address and firmware icon in the top right corner of the OSD.
Note: Disabling 'Display System Info' will remove the IP address from the OSD. When 'Use Full Grid' is enabled, this option will also suppress all firmware version mismatch warnings.
- **Display Date and Time** - when set to On, the current date and time are displayed on the OSD menu.
- **Background Brightness** - determines the brightness of the OSD thumbnail views when the mouse is not hovering over them. Five settings are available, from 100% down to 20%. If set to 100% then all thumbnails remain at full brightness all of the time. Whereas, at 20% all thumbnails will darken until the mouse hovers over one of them, at which point it will come to full brightness to clearly highlight it against all the others.

4.5.4 Central Switch > Manage EDIDs

This page lists the EDID (Extended Display Identification Data) profiles that are currently available:

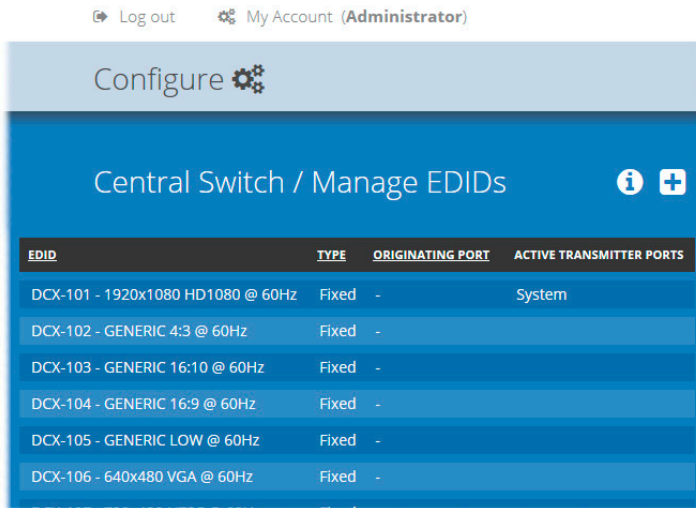

- EDID - shows the resolutions and refresh rates for all profiles that are currently stored.
- Type - indicates where each EDID profile originated: Fixed EDIDs are included within the switch firmware and cannot be removed. User EDIDs are those that have been cloned from particular video displays attached to DCX-DVR modules - these can be deleted if required. On the main [Central Switch/General](#) page you can select the 'Default System EDID' from the list of fixed and user EDIDs.
- Originating Port - indicates which switch port supplied each user EDID.
- Active Local Ports - indicates which local modules (if any) are currently using each EDID.

Note: The Switch will modify the EDID, if a Dual link monitor is connected, to list only the video resolutions that it is capable of supporting.

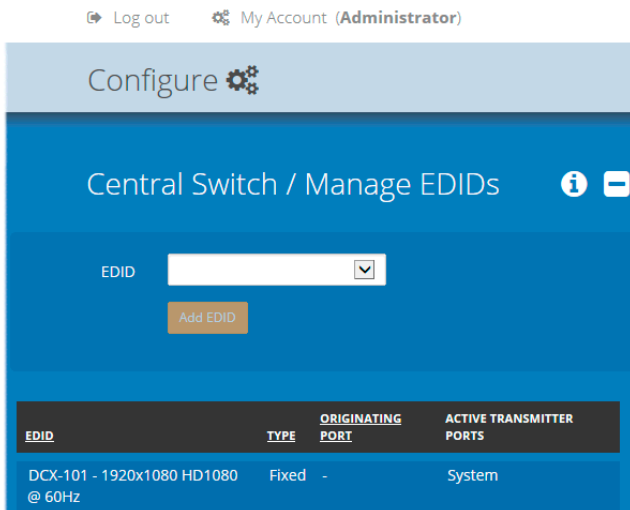

4.5.4.1 Add EDID

If additional EDID definitions are required for your installation, you can clone new definitions from connected video displays and add these to the list of available definitions.

Click the [+] icon to begin collecting a new EDID from a display attached (via a DCX-DVR module) to one of the switch ports.

Click the EDID dropdown list and choose the appropriate remote (DCX-DVR module) from which you wish to clone a new EDID profile. Then click the Add EDID button.

For details about applying an EDID to a particular computer, see [Configure > Computers > Locals](#).

4.6 Configure > Consoles

A Console is a collective term for a set of peripheral devices arranged around one or more DCX-DVR modules. This page lists all registered consoles alphabetically by their Names:

Log out My Account (Administrator)

Configure

Consoles +

Click a heading to reorder the whole list in ascending or descending order according to the entries within the chosen column.

NAME	DESCRIPTION	PORTS	OSD MOUSE LAUNCH	CONNECTED COMPUTER	CURRENT ACCESS MODE	<input type="checkbox"/>
Console 01	Console on Port 21	[21]	On	-		<input type="checkbox"/>
Console 02	Console on Port 22	[22]	On	-		<input type="checkbox"/>
Console 03	Console on Port 23	[23]	On	-		<input type="checkbox"/>
Console 04	Console on Port 24	[24]	On	-		<input type="checkbox"/>
Console 05	Console on Port 25	[25]	On	-		<input type="checkbox"/>
Console 06	Console on Port 26	[26]	On	-		<input type="checkbox"/>
Console 07	Console on Port 27	[27]	On	-		<input type="checkbox"/>

Delete Selected

Add new

Click to add a new console. See opposite.

Edit

Click an entry to view/edit its details and access permissions. See page 30.





In addition to the *Name* and *Description*, other columns provide the following details and options for each console entry:

- Ports - each DCX-DVR module connects to a single port on the DCX1000/3000 Switch. This column lists the port(s) used by the DCX-DVR module(s) associated with each console. Two or more DCX-DVR modules can be combined to form multi-head consoles, each connecting to separate ports.
Note: For consoles with multiple displays (multi-head), additional user console ports are required. If there are no spare user console ports available then any unused computer ports on the rear panel can be deleted in order to free them up as spares. See [Reallocating ports](#).
- OSD Mouse Launch - when set to On, allows the console user to invoke the on Screen Display by holding down their center mouse button and then clicking the right button.
- Connected Computer - shows to which computer the console is currently connected.
- Current Access Mode - indicates how the console is currently connected to the listed computer: = View only, = Shared access, = Exclusive, = Private
- Tick box - Allows you to tick all required console entries and then remove them collectively using the Delete Selected button.

The screenshot shows the 'Configure' section of the DCX Switch interface. At the top, there are links for 'Log out' and 'My Account (Administrator)'. Below this is a 'Configure' header with a gear icon. The main section is titled 'Consoles' and contains a form for adding a new console. The form fields are: 'Name' (Required), 'Description', 'OSD Mouse Launch' (set to OFF), 'Port - Primary Head' (a dropdown menu with a red 'x' icon and a green '+' icon below it), and 'Access Permissions' (a dropdown menu with icons for View, Shared, Exclusive, and Private, and a red 'x' icon and a green '+' icon below it). At the bottom of the form is an 'Add Console' button.

4.6.1 Add new

Click the [+] icon to begin adding a new console, either before or after connecting the DCX-DVR module(s):

- Name - the main identifier for the new console.
- Description - a further opportunity to add more information about the console.
- Ports - add the user port number (located on the main switch) used by the DCX-DVR module associated with this console. For multi-head consoles, ensure that the port used by the primary DCX-DVR module (the one that has the primary display and peripherals attached) is the first one in the list. If you require more than the usual 10 console ports, see [Reallocating ports](#).
- Access Permissions - click the [+] button to select one or more computers that this console will be permitted to access. For each computer choose the appropriate access permissions (see [Access permissions](#)):  = View only,  = Shared access,  = Exclusive,  = Private
- Add Console - click to save your settings.

4.6.2 Configure > Consoles > Edit an entry





Click on an entry within the Configure > Consoles list to display this page. Here you can edit the configuration details for a chosen console.

The screenshot displays the Black Box web interface for editing a console entry. The interface is divided into a left sidebar and a main content area. The sidebar contains navigation links: DASHBOARD, CONTROL, CONFIGURE, CENTRAL SWITCH, NETWORK, OSD SETTINGS, MANAGE EDIDS, CONSOLES, REMOTES, COMPUTERS, LOCALS, and USERS. The main content area is titled 'Configure' and 'Consoles / Console 01'. It includes the following elements:

- Name:** Console 01
- Description:** Console on Port 21
- OSD Mouse Launch:** ON
- Port - Primary Head:** Port: 21 - currently in use by: Console (with a dropdown menu and a red 'x' icon)
- Access Permissions:** A table with columns for computer selection and control icons.

Computer 01	[Eye]	[Share]	[Lock]	[Unlock]	[Red X]
Computer 02	[Eye]	[Share]	[Lock]	[Unlock]	[Red X]
Computer 03	[Eye]	[Share]	[Lock]	[Unlock]	[Red X]
Computer 04	[Eye]	[Share]	[Lock]	[Unlock]	[Red X]
Computer 05	[Eye]	[Share]	[Lock]	[Unlock]	[Red X]
Computer 19	[Eye]	[Share]	[Lock]	[Unlock]	[Red X]
Computer 20	[Eye]	[Share]	[Lock]	[Unlock]	[Red X]
- Connected Computer 1:** Computer 01
- Current Access Mode:** [Eye icon]
- Buttons:** Update (orange), Delete (red)

4.6.2.1 Edit

- Name - the main identifier for the console.
- Description - a further opportunity to add more information about the console.
- OSD Mouse Launch - when set to On, allows the console user to invoke the on Screen Display by holding down their center mouse button and then clicking the right button.
- Ports - shows the user port number(s) (located on the main switch) used by the DCX-DVR module(s) associated with this console. For multi-head consoles, ensure that the port used by the primary DCX-DVR module (the one that has the primary display and peripherals attached) is the first one to be defined. If a chosen port is already used, a warning will be displayed, see [Reallocating ports](#).
- Access Permissions - choose which computers this console is permitted to access. For each computer choose one or more of the four icons to set the access permissions:
 -  View only - console user can view a computer's output but not alter it,
 -  Shared access - console user can view and control a computer along with other consoles,
 -  Exclusive - multiple console users can view a computer but only one can control it,
or
 -  Private - console user can view and control the computer privately while other users are locked out.

For further details, see [Access permissions](#).

When you have made your changes, click the Update button at the foot of the page.

4.7 Configure > Consoles > Remotes

At the heart of each console (the collective term for a set of peripherals connected to the DCX system) is a remote unit called a DCX-DVR module.

Log out My Account (Administrator)

BLACK BOX
www.blackbox.com

Configure

Remotes

Click a heading to reorder the whole list in ascending or descending order according to the entries within the chosen column.

PORT NO	CONSOLE NAME	FIRMWARE	MONITOR NO	MONITOR MODEL
21	Console 01	1.01.4024	1	KVM-via-IP
22	Console 02	-	1	-
23	Console 03	-	1	-
24	Console 04	-	1	-
25	Console 05	-	1	-
26	Console 06	-	1	-
27	Console 07	-	1	-
28	Console 08	-	1	-

[View details](#)
Click to view remote details. See page 34.

Listed in order of the switch port to which they are attached, this page shows various details for each DCX-DVR module:

- Firmware - the current internal software version for each DCX-DVR module.
- Monitor No - an index number for each video display. The first monitor for any console will be indexed as '1'. Where a console has more than one video display associated with it (by using additional DCX-DVR modules), this column will show '2', '3', etc. against the secondary, tertiary, etc. DCX-DVR module(s).
- Monitor model - indicates the video display model as reported to the DCX-DVR module to which it is connected.
- Unique ID - (shown only when the Maintenance > Settings > Web UI Mode is set to Advanced) this column displays the unique identifier hardwired into every DCX-DVR remote module.

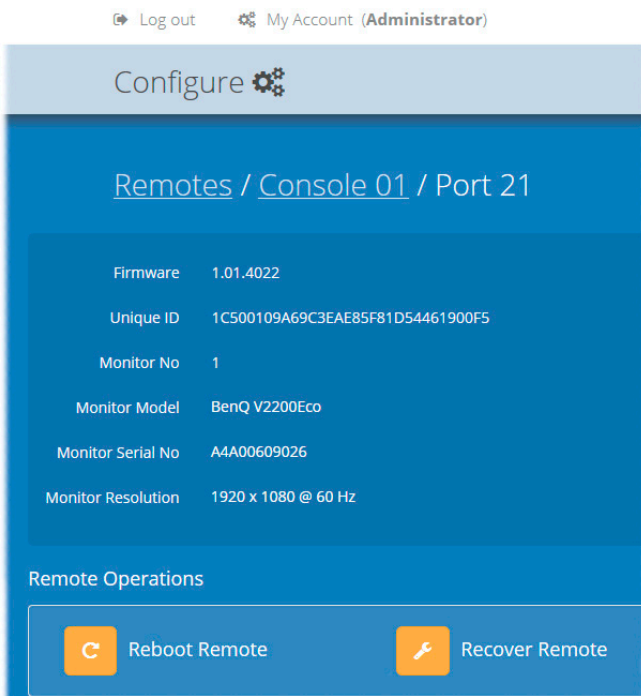

4.7.1 View remote details

Click a remote entry to view the configuration details of the switch port to which it is connected.

Within this page it is possible to reboot and/or recover a remote.

4.7.1.1 Recovering a remote

This option (shown only when the Maintenance > Settings > Web UI Mode is set to Advanced) is used to reprogram a remote that has failed during a firmware upgrade. Once the Recover Remote button is clicked, you will be asked to power cycle the respective module, whereupon it will boot up into recovery mode. Then you will be asked to click a Reprogram button to commence the operation.

4.8 Configure > Computers

This page lists the computer systems that are connected to the switch unit via individual DCX SAM modules:

Log out My Account (Administrator)

Configure

Computers + **Add new**
Click to add a new computer. See page 36.

Click a heading to reorder the whole list in ascending or descending order according to the entries within the chosen column.

NUMBER	NAME	DESCRIPTION	PORTS	THUMBNAIL	PRIMARY CONSOLE	CONNECTED CONSOLES	CURRENT ACCESS MODE	<input type="checkbox"/>
1	Computer 01	Computer description	[1]	✓	-	-		<input type="checkbox"/>
2	Computer 02	Computer description	[2]	✓	-	-		<input type="checkbox"/>
3	Computer 03	Computer description	[3]	✓	-	-		<input type="checkbox"/>
4	Computer 04	Computer description	[4]	✓	-	-		<input type="checkbox"/>
5	Computer 05	Computer description	[5]	✓	-	-		<input type="checkbox"/>
6	Computer 06	Computer description	[6]	✓	-	-		<input type="checkbox"/>
7	Computer 07	Computer description	[7]	✓	-	-		<input type="checkbox"/>
19	Computer 19	Computer description	[19]	✓	-	-		<input type="checkbox"/>
20	Computer 20	Computer description	[20]	✓	-	-		<input type="checkbox"/>

Delete Selected

Edit
Click an entry to view/edit its details and options. See opposite.

In addition to the *Name* and *Description*, the columns also provide the following useful details for each computer entry:

- Port(s) - each DCX SAM module connects to a single port on the DCX1000/3000 Switch. This column lists the port(s) used by the DCX SAM module(s) associated with each computer. Two or more DCX SAM modules can be combined to support extra displays (multi-head), each connecting to a separate port. Three of the user console ports (21 to 23) can be changed into computer ports, if there are fewer user consoles within your installation. See [Reallocating ports](#).
- Thumbnail - indicates whether a thumbnail image of the computer's video output will be shown on the OSD screen for each user. If disabled (unticked), a black image will be shown in the OSD screen.
- Primary Console - indicates the console that currently has control of the computer.
- Connected Consoles - lists all consoles to which each computer is attached.
- Current Access Mode - indicates how the computer is currently being accessed by the listed console:
 - = View only, = Shared access, = Exclusive, = Private
- Tick box - Allows you to tick all required computer entries and then remove them collectively using the Delete Selected button.

Log out My Account (Administrator)

Configure

Computers

Name

Description

Computer Number ⓘ

Port - Primary Head

4.8.1 Add new

Click the [+] icon to begin adding a new computer, either before or after connecting the DCX SAM module(s):

- Name - the main identifier for the new computer.
- Description - a further opportunity to add more information about the computer.
- Computer Number - provides a list of the remaining vacant computer numbers that you can associate with your new entry. The chosen number will determine the position of this computer in the OSD screen and also the hotkey (Ctrl+Alt+n) used to access it. You can swap the number used with other computers within the edit page (see below).
- Ports - Add one or more port numbers used by the DCX SAM module(s) associated with this computer.

4.8.2 Configure > Computers > Edit an entry

This page allows you to edit the configuration details for a chosen computer.

The screenshot shows the configuration page for 'Computer 02'. At the top, there are links for 'Log out' and 'My Account (Administrator)'. The main header is 'Configure' with a gear icon. Below that, the breadcrumb is 'Computers / Computer 02'. The form contains the following fields and controls:

- Name:** Text input field containing 'Computer 02'.
- Description:** Text input field containing 'Computer description'.
- Computer Number:** Dropdown menu showing 'Number: 2 - currently assigned to: Computer 02'.
- Port - Primary Head:** Dropdown menu showing 'Port: 2 - currently in use by: Computer 02' with a red 'x' icon to the right and a green '+' icon below it.
- Thumbnail:** A toggle switch currently set to 'Enabled'.
- Primary Console:** Text input field containing '-'.
- Connected Consoles:** Text input field containing 'Console 01'.
- Current Access Mode:** Text input field containing an eye icon.

At the bottom of the form are two buttons: 'Update' (orange) and 'Delete' (red). Below the form is a section titled 'Locals' with a table header containing 'PORT NO', 'FIRMWARE', and 'MONITOR NO'.

- Name - the main identifier for the computer.
- Description - a further opportunity to add more information about the computer.
- Computer Number - displays a list of computer numbers (used and vacant) that you can associate with this entry. The chosen number will determine the position of this computer in the OSD screen and also the hotkey (Ctrl+Alt+n) used to access it. If you choose a computer number that is already used by another computer, then it and the existing number held by this computer will be swapped over.
- Port(s) - shows the one or more port numbers used by the DCX SAM module(s) associated with this computer. For multi-head computers, ensure that the port used by the primary DCX SAM module (the one linked to the primary video output) is the first one in the list. Three of the user console ports (21 to 23) can be changed into computer ports, if there are fewer user consoles within your installation. See [Reallocating ports](#).
- Thumbnail - indicates whether or not a thumbnail view of this computer's video output should be shown OSD screen for each user.
- Primary Console - indicates the primary console that is connected to this computer.
- Connected Consoles - indicates other consoles that are also connected to this computer.
- Current Access Mode - indicates the access mode (e.g. View Only, Shared, Exclusive, etc.) that is currently being used for this computer.
- Locals - lists the DCX SAM modules that are serving this computer.

When you have made your changes, click the Update button.

4.9 Configure > Computers > Locals

Each computer connects to a DCX SAM module. This page lists each DCX SAM module and their key details:

BLACK BOX
www.blackbox.com

Log out My Account (Administrator)

Configure

Locals

Click a heading to reorder the whole list in ascending or descending order according to the entries within the chosen column.

PORT NO	COMPUTER NAME	FIRMWARE	UNIQUE ID	MONITOR NO
1	Computer 01	1.01.4024	FFBF000568204BAE	1
2	Computer 02	1.01.4024	0110000568204BAE	1
3	Computer 03	-	-	1
4	Computer 04	-	-	1
5	Computer 05	-	-	1
6	Computer 06	-	-	1
7	Computer 07	-	-	1
8	Computer 08	-	-	1
9	Computer 09	-	-	1
10	Computer 10	-	-	1

View details
See opposite.

Listed in order of the switch port to which they are attached, this page shows various details for each DCX SAM module:

- Computer Name - the given name for each connected computer.
- Firmware - the current internal software version for each DCX SAM module.
- Monitor No - an index number for each video display port. The first port for any computer will be indexed as '1'. Where a computer has more than one video display connected it (by using additional DCX SAM modules), this column will show '2', '3', etc. against the secondary, tertiary, etc. DCX SAM module(s).
- Unique ID - (shown only when the Maintenance > Settings > Web UI Mode is set to Advanced) this column displays the unique identifier hardwired into every DCX SAM module.

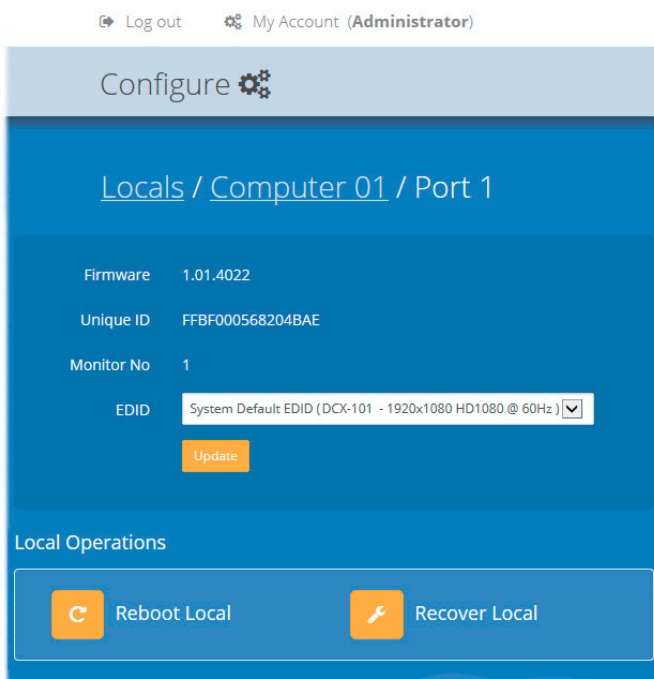

4.9.1 View local module details

Click a locals entry to view the configuration details of the switch port to which it is connected.

Within this page it is possible to reboot and/or recover a remote.

4.9.1.1 Applying a different EDID

If a computer needs to use an EDID profile that differs from the one being used as the default System EDID, use these steps:

- 1 If necessary, clone the required EDID - see [Add EDID](#).
- 2 View the Configure > Computers > Locals page and click on the required computer entry (to show the page shown left).
- 3 Select the appropriate entry from the EDID drop down list.
- 4 Click the Update button.

4.9.1.2 Recovering a local

This option (shown only when the Maintenance > Settings > Web UI Mode is set to Advanced) is used to reprogram a local module that has failed during a firmware upgrade. Once the Recover Local button is clicked, you will be asked to power cycle the respective module, whereupon it will boot up into recovery mode. Then you will be asked to click a Reprogram button to commence the operation.

4.10 Reallocating ports

By default the DCX1000/3000 Switch provide the following user console and computer ports:

- DCX1000 provides 2 user console ports and 8 computer ports (along its rear panel).
- DCX3000 provides 10 user console ports (on its front panel) and 20 computer ports (along its rear panel).

However, these designations are not fixed. If your installation requires a greater number of computers or has a need for more user consoles, you can alter the allocation of these standard ports to suit:

- DCX1000 - You can allocate the ten rear panel ports in any combination.
- DCX3000 - Any of the 20 rear panel computer ports can be reallocated as user console ports, or
- DCX3000 - Three of the front panel ports (labeled 21 to 23) can be used as computer ports.

4.10.1 To reallocate a port that is already being used

1 While creating (or editing) a computer or console entry, choose the required port.

If the port is already being used, when you click the Update button, you will be presented with a warning such as the following:

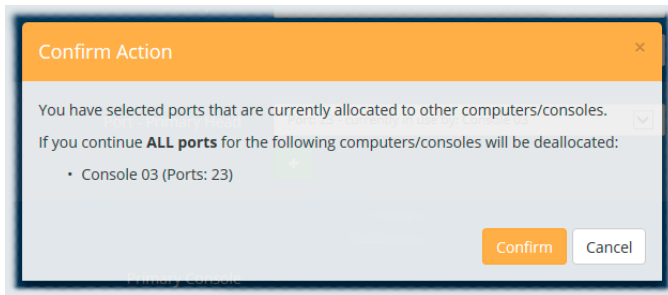

2 Click the Confirm button. The chosen port will first be de-allocated from its existing relationship and then paired to your device. The device that originally used the port will be left without a port allocation and will need separate attention.

Note: *If you reallocate any port from a multi-head computer/console this will cause all ports associated with that computer/console to be de-allocated.*

4.11 The Users page

This page lists all registered users and allows the admin user to add, edit and delete entries, as required.

Note: When changes are made to user details, you are recommended to make a backup file.

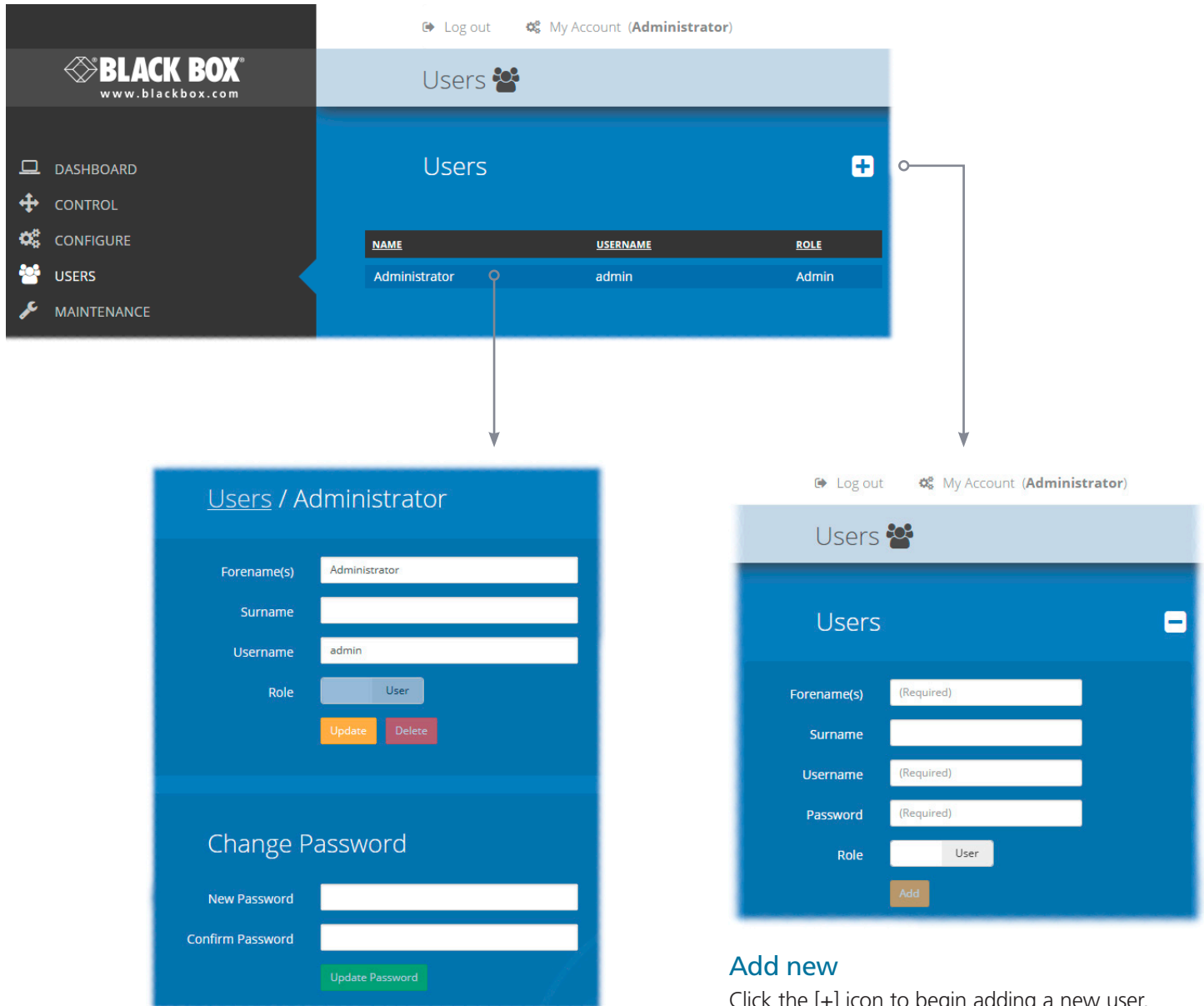

Add new

Click the [+] icon to begin adding a new user.

Edit

Click a user entry to edit its details.

Note: It is not possible to delete the Administrator account if it is the only administrator account remaining.

4.12 The Maintenance pages

The Maintenance section contains three pages: Diagnostics, System Operations and Settings.

4.12.1 Maintenance > Diagnostics

This page provides important feedback on power inputs (and switch Temperatures). The temperature information is displayed only when the Maintenance > Settings > Web UI Mode is set to Advanced.

Log out My Account (Administrator)

Maintenance

Diagnostics

Supply	
Supply A	Supply OK
Supply B	No Supply

Temperature	
CPU core	55 ° C
Case	27 ° C
Board	42 ° C
X-Point (Red)	42 ° C
X-Point (Blue)	38 ° C
X-Point (Green)	35 ° C

Ports			
NUMBER	TYPE	UPTIME	STATUS
1	transmitter	0 days, 20 hours, 4 minutes, 41 seconds	Operational
21	receiver	0 days, 20 hours, 4 minutes, 42 seconds	Operational

This section indicates the status of the mains power input(s).

These items are only shown when Settings > Advanced Mode On is chosen. This section indicates the current temperature readings within the switch for the following:

- The processor core,
- The internal case area,
- The main circuit board,
- The red, green and blue video switches.

This section lists the currently active ports, their uptime and status.

4.12.2 Maintenance > System Operations

This page provides a selection of important system operations that may be required at various times.

The screenshot shows the Black Box web interface. At the top right, there are links for 'Log out' and 'My Account (Administrator)'. The main header is 'Maintenance' with a wrench icon. The left sidebar lists navigation options: DASHBOARD, CONTROL, CONFIGURE, USERS, MAINTENANCE, DIAGNOSTICS, SYSTEM OPERATIONS, and SETTINGS. The main content area is titled 'System Operations' and displays 'System Version: 1.01'. Below this, there are six operation buttons arranged in two rows. The first row contains 'Upgrade Firmware', 'Sync Tx / Rx Firmware', and 'Reboot System'. The second row contains 'Backup', 'Restore', and 'Factory Reset'. Each button has an icon and a brief description of the operation.

Upgrade Firmware

Upgrades the firmwares of all of the switch and all connected modules to the latest version. Confirmation is required once this button is clicked.

Sync Tx/Rx Firmware

Upgrades the firmwares of all connected modules to match that of the main switch. Confirmation is required once this button is clicked.

Note: Be sure that the switch has the latest firmware installed before using this option.

Reboot System

Performs a complete reboot of the entire DCX system, including the switch and all modules. Confirmation is required once this button is clicked.

Backup

Saves a copy of the DCX Matrix system configuration to a file. Backup files are stored on the computer viewing DCX Matrix.

Restore

Restores the DCX Matrix system configuration from a backup file. A file dialog will be displayed to allow you to choose the filename and location.

Factory Reset

Returns all DCX system configuration settings back to their factory defaults.

4.12.3 Recovering an unresponsive local or remote unit

If a firmware upgrade to a local or remote has failed, the unit may become unresponsive. If so, please follow the advice provided in other sections of this guide:

- [Recovering a local](#)
- [Recovering a remote](#)

4.12.3 Maintenance > Settings

This page provides options related to the user interface. When you make a change, you need to click the Update button to save it.

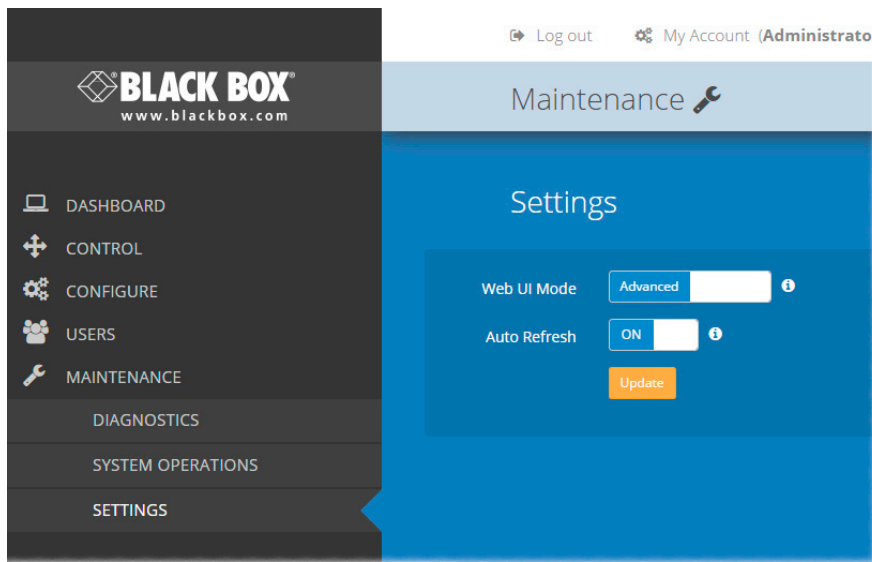

Web UI Mode

When this option is set to Advanced, extra details are shown on certain pages, such as:

- Configure > Central Switch > General
- Configure > Consoles > Remotes
- Configure > Computers > Locals
- Maintenance > Diagnostics

Auto Refresh

When this option is set to On, the Dashboard, Control and Diagnostic pages will automatically update their contents every few seconds.

Update

Click this button to save and enact any changes made to options.

4.13 Resetting and recovering

There may be rare occasions when the main switch or a module needs to be given a hard reset. The DCX1000/3000 Switch and DCX-DVR module both have concealed reset buttons for this purpose. You need to use a narrow implement (e.g. a straightened-out paper clip) to press-and-hold the recessed reset button on the front panel:

4.13.1 DCX1000/3000 Switch

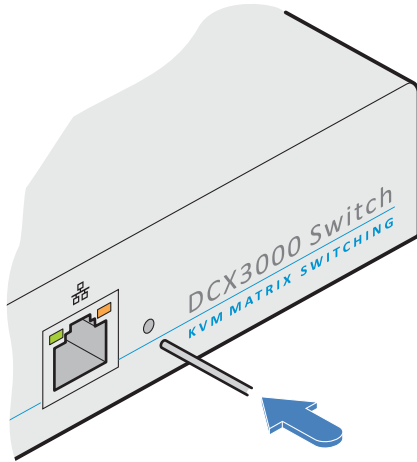

4.13.1.1 DCX1000/3000 Switch > Boot into recovery image

This procedure may be necessary if an attempted firmware upgrade has failed. For such a situation the DCX1000/3000 Switch always retains a recovery image that will return the unit to a working condition, prior to reattempting a firmware upgrade. Note: All configuration data (e.g. users, consoles, computers, networking, etc.) will be retained.

- 1 Press-and-hold the recessed reset button for ten seconds until the STS (Status) indicator begins to flash slowly.
- 2 Release the reset button. The STS indicator will go out and the switch will boot itself using the recovery image. The STS indicator will now begin to flash again to indicate that it is running from the recovery image (a red banner will also be shown at the top of the DCX Matrix screen).
- 3 When you are sure of operating conditions, such as having good power stability, proceed once again with the firmware upgrade.

4.13.1.2 DCX1000/3000 Switch > Reset

This procedure may be necessary if the switch has become unresponsive. *Note: All configuration data (e.g. users, consoles, computers, networking, etc.) will be retained.*

- 1 Press-and-release the recessed reset button. The switch will reboot.

4.13.2 DCX-DVR module

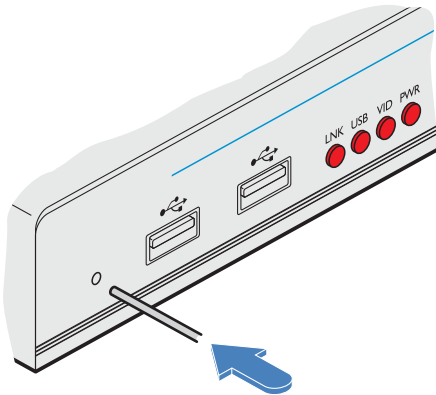

4.13.2.1 DCX-DVR module > Boot into recovery mode

This procedure may be necessary if an attempted firmware upgrade has failed. For such a situation the DCX-DVR module always retains a recovery image that will return the unit to a working condition, prior to reattempting a firmware upgrade.

- 1 Press-and-hold the recessed reset button for ten seconds until the PWR indicator begins to flash quickly.
- 2 Release the reset button.
- 3 When you are sure of operating conditions, such as having good power stability, proceed once again with the firmware upgrade.

4.13.2.2 DCX-DVR module > Reset

This procedure may be necessary if a DCX-DVR has become unresponsive.

- 1 Press-and-release the recessed reset button. The DCX-DVR module will reboot.

4.13.2.3 Recovering an unresponsive transmitter or receiver

If a firmware upgrade to a transmitter or receiver has failed, the unit may become unresponsive. If so, please follow the advice provided in other sections of this guide:

- [Recovering a local](#)
- [Recovering a remote](#)

5. Operation

The DCX system is designed to be transparent in operation. A simple OSD (On Screen Display) interface allows each user to view and select from the available host computers.

5.1 Viewing the OSD

To view the OSD, either:

- From a console keyboard, press CTRL + ALT + M, or
- From a console mouse, press and hold the middle button and then press the right button.

The OSD will be displayed:

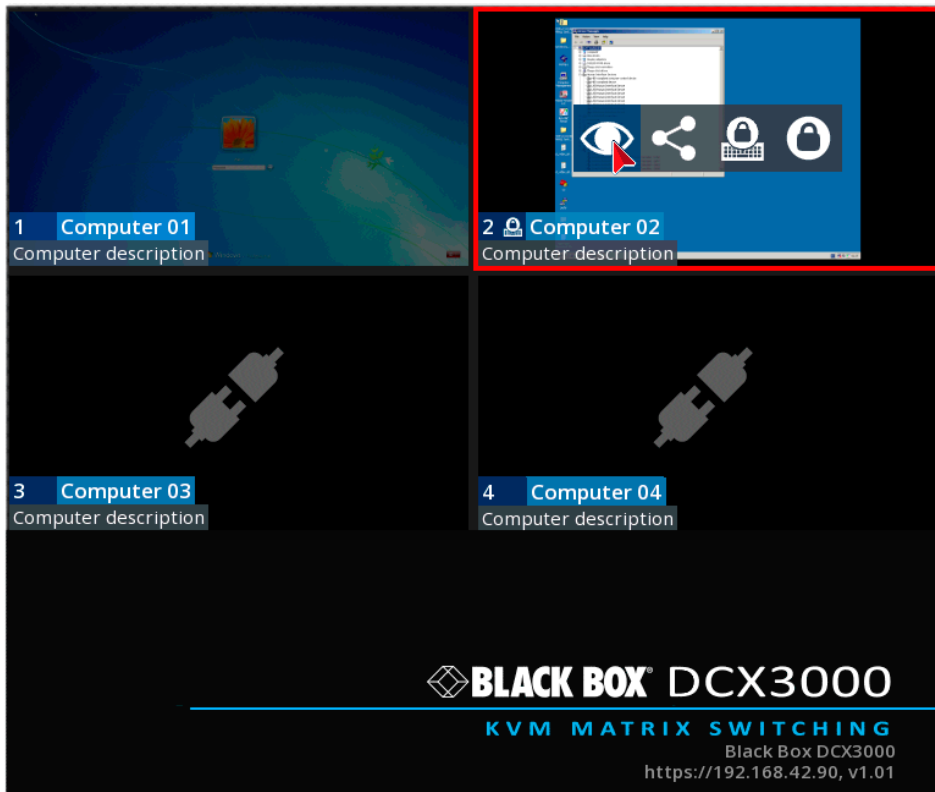

Thumbnail images

The outputs of the available host computers will be displayed within live thumbnail images.

Note: If video is not available for a computer, or the Thumbnails option has been set to OFF, a black image will be shown. See Central Switch > OSD Settings.





Switch information

The additional information in the lower right corner, including the current IP address setting, firmware version and any current firmware upgrade warnings/errors, is displayed within the OSD screen, providing the *Display System Info* option is set to ON. See Central Switch > OSD Settings.

5.2 Choosing a computer

5.2.1 To choose a computer using the mouse

- 1 Display the OSD from your console using either of the methods shown on the previous page.
- 2 Hover the mouse pointer over the required screen image. A set of popup connection icons will be displayed:

-  View only - you can view a computer's output but not alter it,
-  Shared access - you can view and control a computer along with other consoles,
-  Exclusive - multiple users can view a computer but only one (the first to make connection) can control it,
or
-  Private - you can view and control the computer privately while other users are locked out.

For more details, see [Access permissions](#).

Note: If an icon is grayed out, that access method is not available.

- 3 Click the required connection method. The video output from the chosen computer will be displayed full screen and you can use it as normal.

Note: When viewing the OSD, you can also click outside a computer thumbnail to return to your previous computer (with your last access permissions if still available).

5.2.2 To choose a computer using hotkeys (without viewing the OSD)

- Press and hold Ctrl + Alt and type the number of the required computer. The video output from the chosen computer will be displayed full screen and you can use it as normal.

Note: Shared mode is always used when access is made via hotkeys.

5.3 Using Audio

The DCX system fully supports stereo audio, with all audio devices being presented at the linked host computer as USB audio devices. There are slight differences in audio operation between DCX1000/3000 devices acting in a simple extender arrangement (without the use of a DCX1000/3000 Switch) and a full DCX matrix installation.

5.3.1 Using audio in a simple extender installation

The audio is presented to the computer's operating system as a USB headset with controls for input level, input mute, input AGC, sidetone level, sidetone mute, output level, output mute and output balance. The audio device is permanently presented to the computer when the DCX-DVR module powers up.

You can adjust the audio features using all of the standard operating system controls.

Note: Due to the architecture of the Codec, adjusting the input (microphone) level or muting the input (microphone) will also affect the sidetone level and mute.

5.3.2 Using audio in a full DCX matrix installation

Audio functionality is enabled by default on all computers. For multi-head computers, audio is only enabled for the primary transmitter, although two audio devices will be presented to the computer, one for each transmitter. For multi-head consoles, audio is only enabled for the primary receiver.

Managing audio in multi-user situations

- In all connection modes, the audio output of the computer is routed to the receiver from the transmitter.
- In View Only and Shared modes, the receiver input audio is ignored.
- In Exclusive and Private modes, the receiver input audio is routed to the transmitter.

Note: The above is equivalent to routing the output audio as per the video and the input audio as per the USB (except in View Only and Shared modes, where the input audio stream is ignored).

When viewing the OSD selection screen, input and output audio is suppressed.

The user who is currently in control of a computer can adjust the audio levels using the standard operating system audio features; their changes will affect the audio for all other users viewing the same computer. Additional users connected in View Mode, or additional Shared Access users who don't have control, can listen to the audio but at the volume dictated by the main user. As a user switches between machines, their audio levels are automatically adjusted to match their current connection.

5.4 Indicators

The DCX1000/3000 Switches, the DCX SAM and DCX-DVR modules contain various indicators to provide you with status information.

5.4.1 DCX1000/3000 Switch - Red front panel status indicators

The red status indicators on DCX1000/3000 Switch front panels provide various key power and operation feedback:

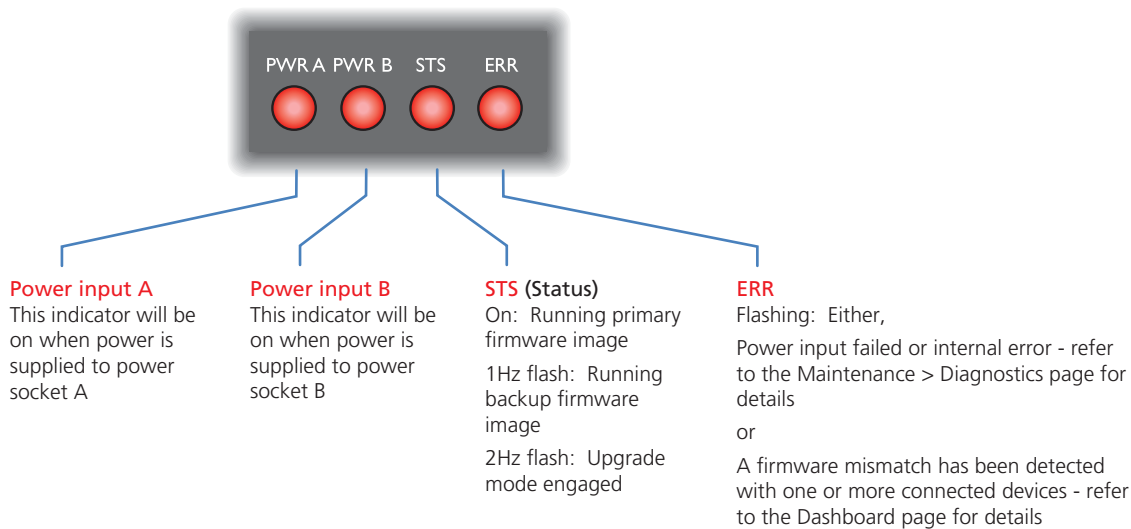

5.4.2 DCX1000/3000 Switch - Green and amber network status indicators

The green and amber status indicators on the network link port provide further status information:

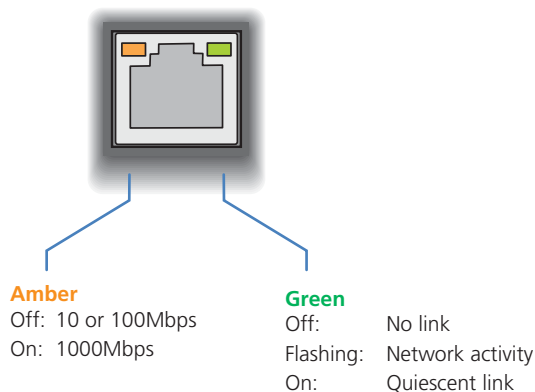

5.4.3 DCX-DVR module - Green and amber status indicators

The green and amber indicators on the link port of each DCX-DVR module provide the following status information:

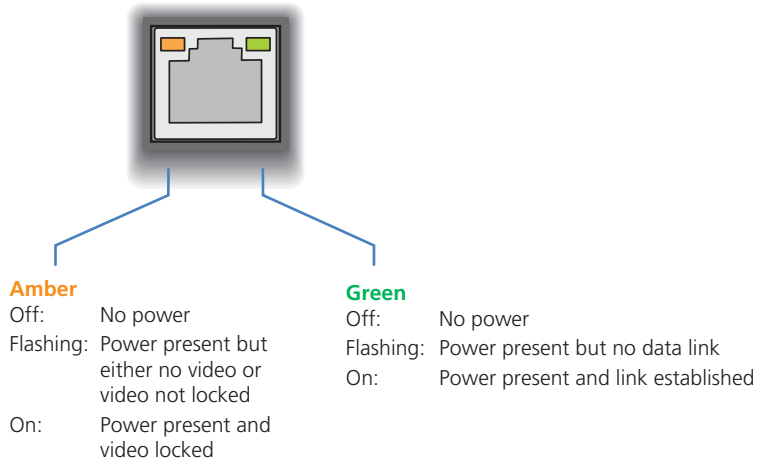

5.4.4 DCX-DVR module - Red front panel status indicators

The red indicators on the front panel of each DCX-DVR module provide the following status information:

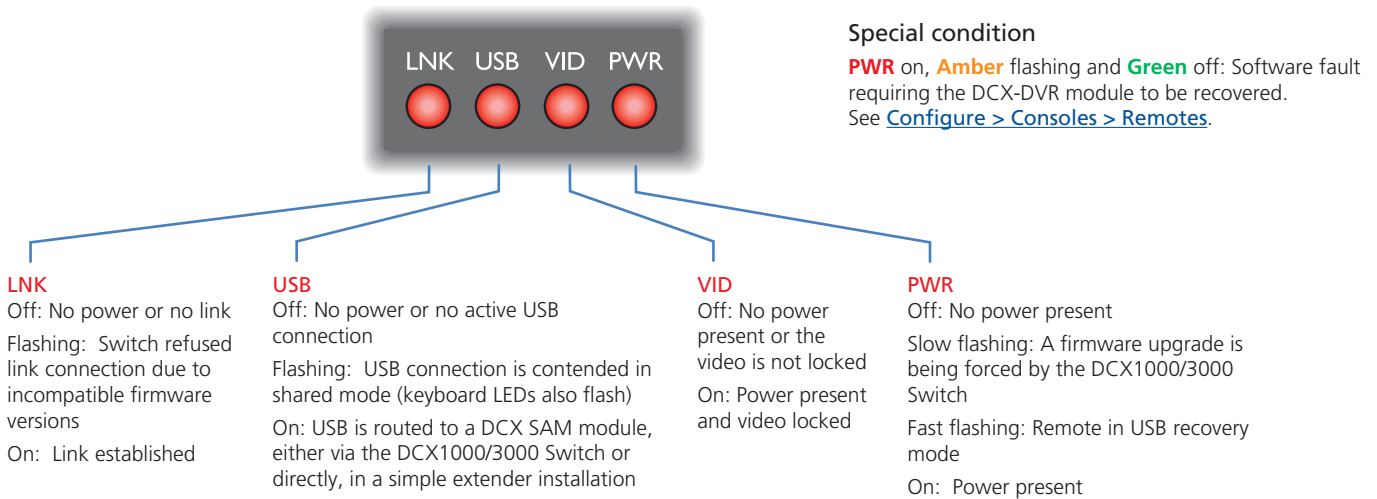

5.4.5 DCX SAM module - Green and amber status indicators

The green and amber indicators on the link port of each DCX SAM (computer) module provide the following status information:

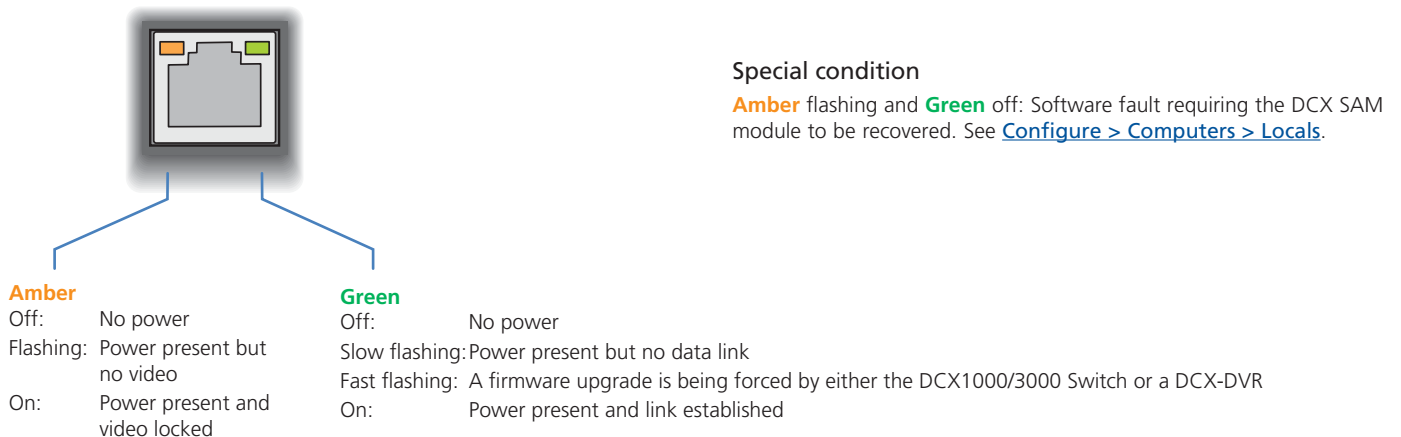

Appendix A. Safety Information

- For use in dry, oil free indoor environments only.
- Do not use to link between buildings.
- Ensure that the twisted pair interconnect cable is installed in compliance with all applicable wiring regulations.
- Do not connect the CATx link interface (RJ45 style connector) to any other equipment, particularly network or telecommunications equipment.
- Warning – the power adapter contains live parts.
- No user serviceable parts are contained within the power adapter - do not dismantle.
- Plug the power adapter into a grounded socket outlet close to the unit that it is powering.
- Replace the power adapter with a manufacturer approved type only.
- Do not use the power adapter if the power adapter case becomes damaged, cracked or broken or if you suspect that it is not operating properly.
- If you use a power extension cord with the units, make sure the total ampere rating of the devices plugged into the extension cord do not exceed the cord's ampere rating. Also, make sure that the total ampere rating of all the devices plugged into the wall outlet does not exceed the wall outlet's ampere rating.
- Do not attempt to service the units yourself.
- The units and power supplies can get warm in operation – do not situate them in an enclosed space without any ventilation.
- The units do not provide ground isolation and should not be used for any applications that require ground isolation or galvanic isolation.

Appendix B. Firmware upgrades for basic extender installations

Extender systems (or individual DCX-DVR units) can be upgraded using a USB stick if required. This is carried out as follows:

- 1 Connect the DCX-DVR to a compatible display and keyboard; optionally connect to a DCX SAM module using a CATx data cable to upgrade it at the same time.
- 2 On the DCX-DVR unit, insert a FAT32-formatted USB stick containing the extender firmware upgrade file into one of the front USB ports. *Note: The extender firmware upgrade file must be in the root folder.*
- 3 Apply power to the DCX-DVR unit and DCX SAM modules.
IMPORTANT: Ensure power remains uninterrupted throughout the upgrade process.
- 4 Press-and-hold the recessed reset button for ten seconds until the PWR indicator begins to flash quickly, then release the reset button.
- 5 When prompted, type in the name of the extender firmware upgrade file and press Enter.
- 6 Type Y or N as appropriate, when asked if an attached (DCX SAM) transmitter unit should also be upgraded.
- 7 The display will show the upgrade progress and confirmation message.
- 8 If successful the DCX-DVR and DCX SAM modules will automatically be rebooted and the USB stick can be removed.

Appendix C. Link cable interference protection

While the Category rating (e.g. CAT 5e, CAT 6a, CAT 7, etc.) determines the electrical performance of a cable, another vital part of the overall cable specification is its protection from interference. As cabling distances and data rates increase, so too does the susceptibility to interference, from both external and internal sources.

Proximity to other electromagnetic sources are the main external threat and these can be subdued using overall screening that surrounds all four of the cable pairs. However, interference is also possible from neighbouring twisted pairs within the same cable and this can be just as hazardous to data integrity. Such *crosstalk* is countered by shielding each cable pair separately.

Within each Category rating, you can specify different combinations of external screening and internal shielding to suit the environment into which the link is being placed.

Interference protection codes

Interference protection is classified in the following manner:

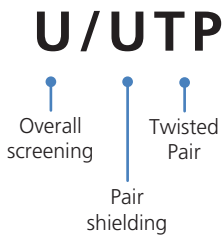

where

- U = unshielded
- F = foil shielding
- S = braided shielding
- PiMF = Pairs in Metal Foil

Name	Overall Screening	Pair Shielding
U/UTP	✗	✗
F/UTP	✓	✗
U/FTP	✗	✓
S/FTP or S/STP or PiMF	✓	✓

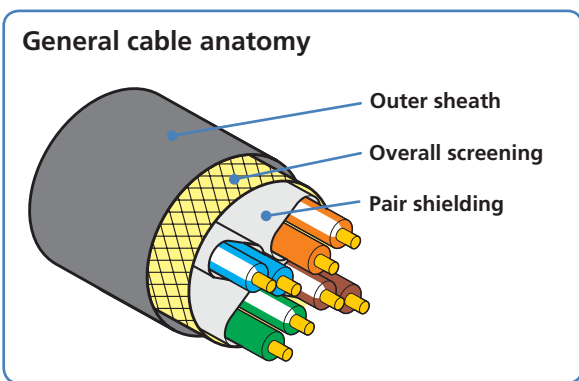
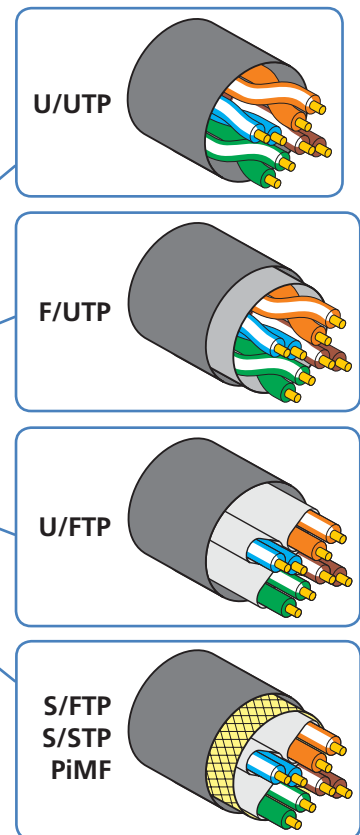

Black Box Tech Support: FREE! Live. 24/7.

Tech support the
way it should be.



Great tech support is just 60 seconds away at [877-877-2269](tel:877-877-2269) or blackbox.com.



About Black Box

Black Box provides an extensive range of networking and infrastructure products. You'll find everything from cabinets and racks and power and surge protection products to media converters and Ethernet switches all supported by free, live 24/7 Tech support available in 60 seconds or less.

© Copyright 2016. Black Box Corporation. All rights reserved. Black Box® and the Double Diamond logo are registered trademarks of BB Technologies, Inc. Any third-party trademarks appearing in this manual are acknowledged to be the property of their respective owners.

DCX3000, rev. 1.3a RC1