

# USER MANUAL



**PowerWalker**  
**VFI 1000-2000-3000 TG**  
**VFI 1000-2000-3000 TGS**

---

## **CONTENT**

<b>1. Safety and EMC Instructions .....</b>	<b>1</b>
1.1 Installation .....	1
1.2 Operation .....	2
1.3 Maintenance, servicing and faults .....	3
1.4 Transport .....	4
1.5 Storage .....	4
1.6 Standards .....	4
<b>2. Description of Commonly Used Symbols .....</b>	<b>6</b>
<b>3. Introduction .....</b>	<b>7</b>
<b>4. Panel Description .....</b>	<b>9</b>
4.1 Button .....	9
4.2 LCD description .....	10
<b>5. Connection and Operation .....</b>	<b>13</b>
5.1 Inspection: .....	13
5.2 Connection: .....	13
5.3 Battery charge: .....	16
5.4 Turn on the UPS: .....	16
5.5 Test function: .....	16
5.6 Turn off the UPS: .....	17
5.7 Audible alarm mute function: .....	17
<b>6. Operating Mode for All Models .....</b>	<b>18</b>
6.1 Line mode .....	19
6.2 Battery mode .....	20
6.3 Bypass mode .....	21
6.4 No Output mode .....	21
6.5 EPO (Emergency Power Off) .....	22
6.6 ECO mode (Economy mode) .....	22
6.7 CVCF mode .....	22
6.8 Abnormal mode .....	23
<b>7. Setting by LCD Module .....</b>	<b>23</b>

---

<b>8. Trouble Shooting .....</b>	<b>28</b>
<b>9. Maintenance .....</b>	<b>31</b>
9.1 Operation .....	31
9.2 Storage.....	31
<b>10. Technical Data.....</b>	<b>32</b>
10.1 Electrical specifications.....	32
10.2 Operating Environment.....	32
10.3 Typical backup time (Typical values at 25°C in minutes : ).....	33
10.4 Dimensions and weights .....	33
<b>11. Communication Port.....</b>	<b>34</b>
11.1 USB (Optional) and RS-232 Communication Ports .....	34
11.2 USB for HID power device .....	34
11.2 AS400 Interface (Option).....	34
11.2 CMC Interface (Option).....	34
11.2 NMC Interface (Option).....	34
<b>12. Software.....</b>	<b>35</b>
<b>Appendix: Rear panel .....</b>	<b>36</b>

## 1. Safety and EMC Instructions

**Please read carefully the following user manual and the safety instructions before installing or operating the unit!**

### 1.1 Installation

- ★ See installation instructions before connecting to mains power.
- ★ Condensation may occur if the UPS is moving directly from a cold to a warm environment. The UPS must be absolutely dry before being installation. It is recommended to have an acclimatization time at least two hours.
- ★ Do not install the UPS near water or in damp environment.
- ★ Do not install the UPS where it would be exposed to direct sunlight or near heat.
- ★ Do not connect appliances or items of equipment which would overload the UPS (e.g. laser printers, etc.) to the UPS output.
- ★ Place cables properly to avoid someone treaded or tripped over them.
- ★ Assure to connect with the earth reliably.
- ★ Connect the UPS only to a socket outlet which is earthed shockproof type.
- ★ The building wiring socket outlet (shockproof socket outlet) must be easily accessible to close to the UPS.
- ★ With the installation of the equipment, the sum of the leakage current of the UPS and the connected load does not exceed 3.5mA.
- ★ An additional circuit breaker or fuse with rating 16A and breaking capacity 3kA shall be used between power source and input when installation this unit.
- ★ Do not block ventilation openings on the UPS's housing. Ensure the air vents on the front, side and rear of the UPS are not blocked.

Recommended at least 25cm of space on each side. The air flow diagram is shown as below:

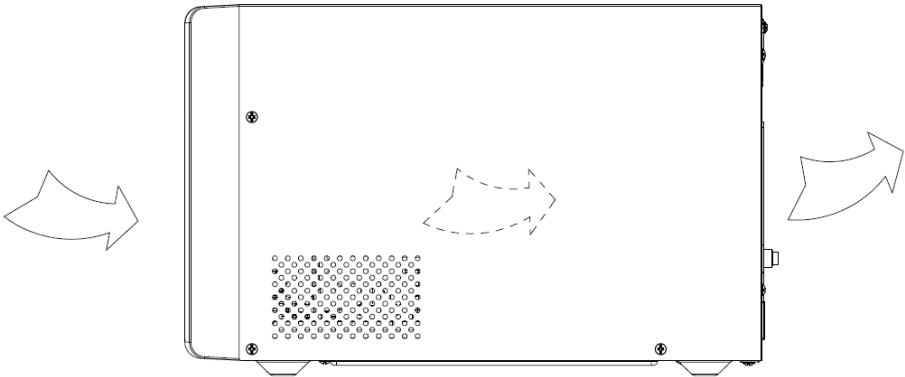

■ **Figure 1.1 The Air Flow Diagram**

- ★ This UPS receives power from more than one source-disconnection of AC source and the DC source is required to de-energize this unit before servicing.

## 1.2 Operation

- ★ For safety consideration, do not disconnect the mains cable on the UPS or the building wiring socket (grounded shockproof socket) during operation, the grounding for the UPS and all loads connected will be disconnected.
- ★ The UPS features its own, internal current source (batteries). You may be electric shocked when you touch the UPS output sockets or output terminal block even if the UPS is not connected to the building wiring socket.
- ★ In order to fully disconnect the UPS, first press the OFF button to turn off the UPS, and then disconnect the mains lead.
- ★ Ensure that no liquid or other external objects can enter the UPS.
- ★ Do not remove the enclosure. This system is to be serviced by qualified service personnel only. There are NO USER

---

SERVICEABLE PARTS inside the UPS.

- ★ Remove the protective panel only after disconnecting the terminal connections.

### **1.3 Maintenance, servicing and faults**

- ★ The UPS operates with hazardous voltages. Repairs may be carried out only by qualified maintenance personnel.
- ★ Caution - risk of electric shock. Even after the unit is disconnected from the mains power supply (building wiring socket), components inside the UPS are still connected to the battery which are potentially dangerous.
- ★ Before carrying out any kind of service and/or maintenance, disconnect the batteries. Verify that no current is present and no hazardous voltage exists in the capacitor or BUS capacitor terminals.
- ★ Batteries must be replaced only by qualified personnel.
- ★ Caution - risk of electric shock. The battery circuit is not isolated from the input voltage. Hazardous voltages may occur between the battery terminals and the ground. Verify that no voltage is present before servicing!
- ★ Batteries have a high short-circuit current and pose a risk of shock. Take all precautionary measures specified below and any other measures necessary when working with batteries:
  - remove all jewellery, wristwatches, rings and other metal objects
  - use only tools with insulated grips and handles.
  - Wear rubber gloves and boots.
  - Do not lay tools or metal parts on top of batteries.
  - Disconnect the charging source prior to connecting or disconnecting battery terminals.
- ★ When changing batteries, replace with the same quantity and the same type of batteries.
- ★ Do not attempt to dispose of batteries by burning them. It could

---

cause explosion.

- ★ Do not open or destroy batteries. Effluent electrolyte can cause injury to the skin and eyes. It may be toxic.
- ★ Please replace the fuse only by a fuse of the same type and of the same amperage in order to avoid fire hazards.
- ★ Do not dismantle the UPS, except the qualified maintenance personnel.

## **1.4 Transport**

- ★ Please transport the UPS only in the original packaging (to protect against shock and impact).

## **1.5 Storage**

- ★ The UPS must be stockpiled in the room where it is ventilated and dry.











## 1.6 Standards

<b>* Safety</b>	
IEC/EN 62040-1:2008+A1:2013	
<b>* EMI</b>	
Conducted Emission.....:IEC/EN 62040-2	Category C2
Radiated Emission.....:IEC/EN 62040-2	Category C2
Harmonic Current.....:IEC/EN 61000-3-2	
Voltage Fluctuation and Flicker.....:IEC/EN 61000-3-3	
<b>*EMS</b>	
ESD.....:IEC/EN 61000-4-2	Level 3
RS.....:IEC/EN 61000-4-3	Level 3
EFT.....:IEC/EN 61000-4-4	Level 4
SURGE.....:IEC/EN 61000-4-5	Level 3&4
CS.....:IEC/EN 61000-4-6	Level 3
MS.....: IEC/EN 61000-4-8	Level 3
Voltage Dips.....: IEC/EN 61000-4-11	
Low Frequency Signals.....:IEC/EN 61000-2-2	



## 2. Description of Commonly Used Symbols

Some or all of the following symbols may be used in this manual. It is advisable to familiarize yourself with them and understand their meaning:

Symbol and Explanation			
Symbol	Explanation	Symbol	Explanation
	Alert you to pay special attention		Alternating current source (AC)
	Caution of high voltage		Direct current source (DC)
	Turn on the UPS		Protective ground
	Turn off the UPS		Recycle
	Idle or shut down the UPS		Do not dispose with ordinary trash

### 3. Introduction

This On-Line-Series is an uninterruptible power supply incorporating double-converter technology. It provides perfect protection specifically for Linux, UNIX, and Windows servers.

The double-converter principle eliminates all mains power disturbances. A rectifier converts the alternating current from the socket outlet to direct current. This direct current charges the batteries and powers the inverter. On the basis of this DC voltage, the inverter generates a sinusoidal AC voltage, which permanently supplies the loads.

Computers and periphery are thus powered entirely by the mains voltage. In the event of power failure, the maintenance-free batteries power the inverter.

This manual covers the UPS listed as follows. Please confirm whether it is the model you intend to purchase by performing a visual inspection of the Model No. on the rear panel of the UPS.

**The Model List**

Item	Model name	Power Rating	Model type	Model description	Other
1	VFI 1000 TG	1000VA 900W	Tower	Standard model	Single Phase input Single Phase Output
2	VFI 1000 TGS	1000VA 900W	Tower	Long Backup time model	Single Phase input Single Phase Output
3	VFI 2000 TG	2000VA 1800W	Tower	Standard model	Single Phase input Single Phase Output
4	VFI 2000 TGS	2000VA 1800W	Tower	Long Backup time model	Single Phase input Single Phase Output
5	VFI 3000 TG	3000VA 2700W	Tower	Standard model	Single Phase input Single Phase Output
6	VFI 3000 TGS	3000VA 2700W	Tower	Long Backup time model	Single Phase input Single Phase Output

### UPS Block Diagram

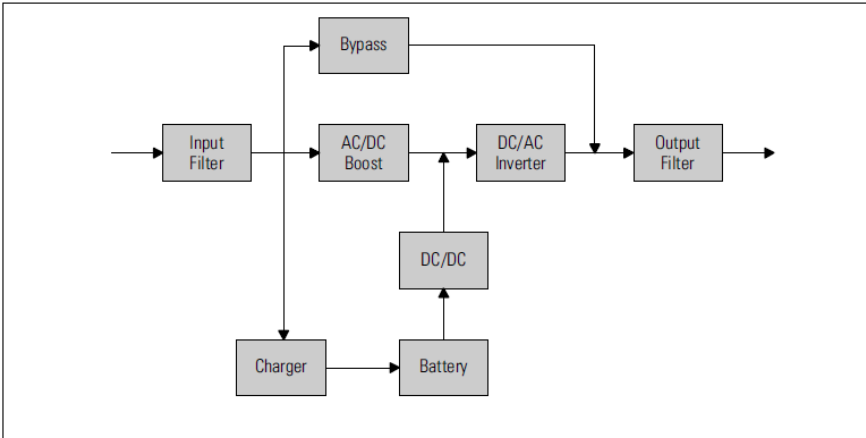

## 4. Panel Description

The display panel of 1000-3000 TG(S) is the same, which is shown as below:

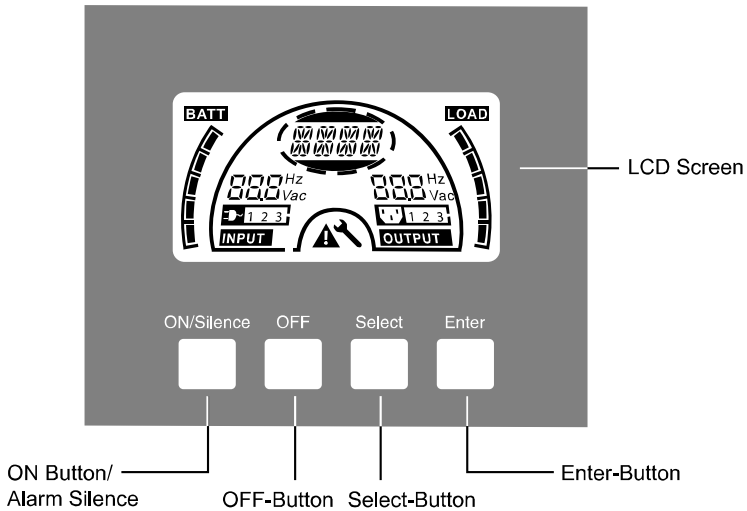

■ Figure 4.1 The Display Panel

### 4.1 Button

Switch	Function
<b>ON/Silence Button</b>	<p>Turn on UPS system: By pressing the ON-Button continuously for more than 1 second the UPS system is turned on.</p> <p>Deactivate acoustic alarm: By pressing this Button an acoustic alarm can be deactivated in the battery mode. By short touch this Button all acoustic alarms can be deactivated in all modes.</p> <p>Do the battery test: By pressing this Button the UPS can do the battery test in the Line mode or ECO mode or CVCF mode.</p>
<b>OFF Button</b>	<p>When mains power is normal, the UPS system switches to No output or Bypass mode by pressing OFF-Button “⏏”, and the inverter is off. At this moment, if Bypass is enabled, then the output sockets are supplied with voltage via the bypass if the mains power is available.</p>

	Deactivate acoustic alarm: By pressing this Button an acoustic alarm can be deactivated in the bypass mode. Release the UPS from fault mode and EPO status.
<b>Select Button</b>	The output voltage, frequency, Bypass disable/enable and operating mode in No output or Bypass mode, Battery Ah, Battery remain time display disable/enable and Charger current in all mode, could be selected by pressing Select-Button, and confirmed by pressing Enter-Button.
<b>Enter Button</b>	



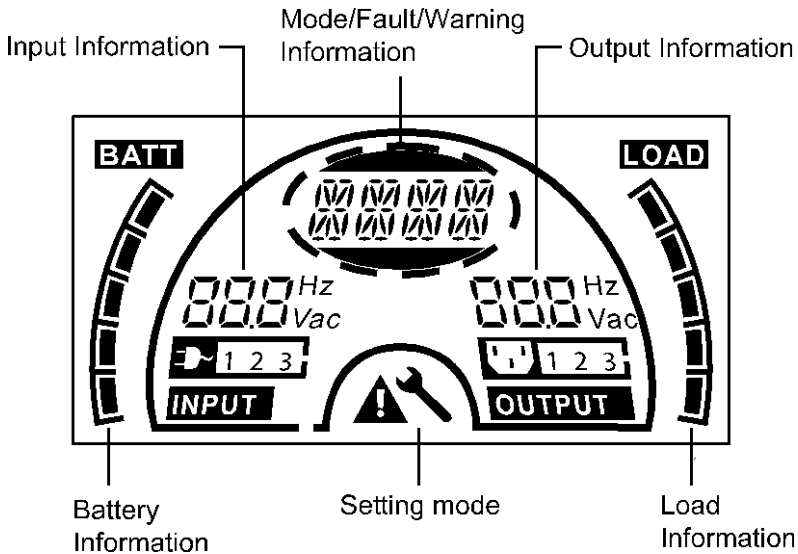



## 4.2 LCD description



■ Figure 4.2 The LCD Display

### LCD icon Function

Display	Function
Input Information	
	It indicates input voltage/frequency value, which are displayed alternately.

	<p>It indicates the input is connected with mains, and the input power is single phase input.</p>
<p>Output Information</p>	
	<p>It indicates output voltage/frequency value, which are displayed alternately.</p>
<p>Load Information</p>	
<p><b>LOAD</b></p> 	<p>It indicates the load level. Every grid represents the level of 20%. One grid would be displayed if the level is 0~20%</p>
<p>Battery Information</p>	
<p><b>BATT</b></p> 	<p>It indicates the battery capacity. Every grid represents the capacity of 20%.</p>
<p>Mode/Fault/Warning Information</p>	
	<p>It Indicates the operating mode or Fault kind or Warning kind or battery remain time, several warning kinds at the same time could be displayed alternately.</p>
<p>Else</p>	
	<p>It indicates the UPS is in setting mode.</p>



It indicates the UPS is in Fault mode or has some warnings.

### LCD display in different mode

The different message/string would be displayed on the LCD screen corresponding to their operating modes, and they are illustrated as the following table. At any time, only one normal operating string or fault string is presented, but the warning, if several warning happen at the same time, they can be displayed on the LCD alternately. And the normal operating mode string and the warning string would be shown circularly. Once one fault is come forth, all previous warnings and the fault string would be shown circularly.

Normal operating mode	Code
No output mode	STbY
Bypass mode	bYPA
Line mode	LINE
Battery mode	bATT
Battery test mode	TEST
ECO mode	ECO
Converter mode	CVCF

## 5. Connection and Operation

The system may be installed and wired only by qualified electricians in accordance with applicable safety regulations!

When installing the electrical wiring, please note the nominal amperage of your incoming feeder.

### 5.1 Inspection:

Inspect the packaging carton and its contents for damage. Please inform the transport agency immediately if you find signs of damage. Please keep the packaging in a safe place for future use.

***Note: To avoid any safety issue, please ensure that the incoming feeder (mains) is isolated completely while whole installing process.***

### 5.2 Connection:

#### (1) UPS Input Connection

If the UPS is connected via the power cord, please use a proper socket with protection against electric current, and pay attention to the capacity of the socket. The UPS System has an input breaker on the standard cabinet.

#### (2) UPS Output Connection

The output sockets and types of the UPS are shown below:

Model No.	Output Socket -SCHUKO(pcs)	Output Socket -IEC(pcs)
VFI 1000 TG	3*Schuko	4*C13



VFI 1000 TGS	2*Schuko	3*C13
VFI 2000 TG	4*Schuko	4*C13
VFI 2000 TGS	2*Schuko+1*C13	6*C13
VFI 3000 TG	4*Schuko	4*C13+1*C19
VFI 3000 TGS	2*Schuko+1*C19	3*C13+Terminal block

### **(3) Battery Input Connection for long backup time model**

When connecting the external batteries it's recommended to pay attention to these following items:

- ★ Use the battery pack with voltage:  
24VDC for 1000 TG(S) (2 pcs of 12V batteries),  
48VDC for 2000 TG(S) (4 pcs of 12V batteries),  
72VDC for 3000 TG(S) (6 pcs of 12V batteries)
- Note: Connection of batteries more than or less than required will cause abnormality or permanent damage.
- ★ One Standard type battery connector on the rear panel is used for connecting the battery pack.
  - ★ The battery connection procedure is very important. Any incompliance may result in the risk of electric shock. Therefore, the following steps must be strictly complied with.
  - ★ Prepare the battery cable with Standard type connector which should be able to carry the current.
  - ★ If there is a battery breaker then turn it off first. Then connect the battery cable to the Standard type battery connector on the rear panel.
  - ★ Connect the input power cord of the UPS to mains power supply, the battery would start to be charged.

**The Caution!**

A DC breaker must be connected between the UPS and external battery if no used standard battery pack.

**The Caution!**

The output sockets of the UPS system may still be electrically live even if the power supply system has been disconnected.

**(4) EPO Connection:**

EPO (Emergency Power Off) function is standard feature for UPS, the polarity of EPO is configurable; EPO is normally close as default setting. If the connection between two ports of EPO connector is disconnected, EPO function will be active and the UPS will stop output power immediately.

- Normally open

Normally EPO connector is open on the rear panel. Once the connector is closed with a wire, the UPS will stop output until EPO status is reset.

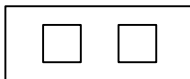

Disable EPO status

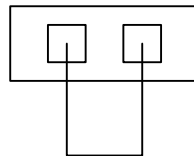

Enable EPO status

- Normally close

Normally EPO connector is closed with a wire on the rear panel. Once the connector is open, the UPS will stop output until EPO status is disabled

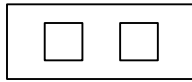

Enable EPO status

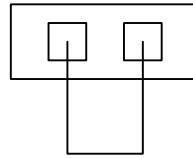

Disable EPO status

### 5.3 Battery recharge:

Fully charge the batteries (external) of the UPS system by leaving the UPS system connected to the mains power for 1-2 hours approximately. The UPS system is able to operate directly without recharging process, but the backup time may be shorter than the nominal value specified.

### 5.4 Turn on the UPS:

#### (1) With mains power connecting:

Press On-button continuously for more than 1 second to turn on the UPS, the UPS will get into the Line mode; the LCD screen will indicate the state of the UPS.

#### (2) Without mains power connecting:

Even though mains power is not connected to the UPS, the UPS still can be turned on by just simply pressing on button continuously for more than 1 second with external batteries connected, the UPS will get into the Battery mode, and the LCD screen will indicate the state of the UPS.

**Note: The default setting for bypass mode is no output after UPS is connecting mains power and breaker is turned on. This can be configurable.**

### 5.5 Test function:

Test function is checking battery performance of the UPS system by pressing the On-Switch for more than 1 second while UPS is operating in Line mode, the UPS would detect whether the battery is connected or the battery is weak. And the UPS could also implement this test automatically and periodically, the period time is configurable.

---

## 5.6 Turn off the UPS:

### (1) In Line Mode:

Press OFF button continuously for more than 1 second to turn off the UPS, the UPS will get into no output or bypass mode. In circumstance, the UPS might have output power if bypass mode is enabled. Disconnect the mains power to turn off the output.

### (2) In Battery Mode:

Press OFF button continuously for more than 1 second to turn off the UPS, the UPS will get into no output or standby mode. After 10s UPS will be shut down completely.

## 5.7 Audible alarm mute function:

If the audio alarm is too annoying in battery mode, the audio alarm is able to mute by press ON button continuously for more than 1 second. Moreover, the audio alarm will be active again when the battery reaches low status for reminding that UPS output power will shut down soon.

If the audio alarm is too annoying in bypass mode, the audio alarm is able to mute by press OFF button continuously for more than 1 second. This action doesn't affect the warning and fault alarm.

In any mode, if the warning or fault alarm is too annoying, you can mute it by press ON button less than 0.5 second, and enable it by press ON button less than 0.5 second again. If the new warning or fault alarm is appeared, the buzzer will beep again.

### Alarm Table List

NO.	Status	Alarm
1	Battery mode	Beep once every 4 sec
2	Battery mode with battery low	Beep once every sec
3	Bypass mode	Beep once every 2 min
4	Overload	Beep twice every sec
5	Warning active (see Warning& Fault Code Table )	Beep once every sec
6	Fault active	Beep continuously
7	Button function active	Beep once

## 6. Operating Mode for All Models

The different string could be displayed on the LCD screen corresponding to their operating modes, and they are illustrated as the following table. At any time, only one normal operating string or fault string is presented. But the warning, even several warnings could appear in a certain normal operating mode at one time. And the normal operating mode string and the warning string would be shown circularly. Once one fault is come forth, then all previous warnings would not be shown again but only the fault string is presented.

Warning& Fault Code Table 6.1

Warning	String
Site fail	SITE
Fan fail	FANF
Battery over voltage (over charged)	HIGH
Battery low	bLOW
Charge fail	CHGF
Inverter temperature high	TEPH
Battery open	bOPN

Overload	OVLD
Digital bigger charger fail	dCHF
Inner temperature high	ITPH
<b>Fault</b>	<b>String</b>
Inverter short	SHOR
Overload fault	OVLD
Inverter soft start fail	ISFT
Bus soft start fail	bSFT
Over temperature fault	OVTP
Inverter Volt Low	INVL
Inverter Volt High	INVH
Bus volt over	bUSH
Bus volt Low	bUSL
Bus short	bUSS
Inverter NTC open	NTCO
Emergency Power Off	EPO

## 6.1 Line mode

The LCD display in Line mode is shown as figure6.1. The information about the mains power, the battery level, the UPS output and the load level will be displayed. The “LINE” string indicates UPS working in Line mode.

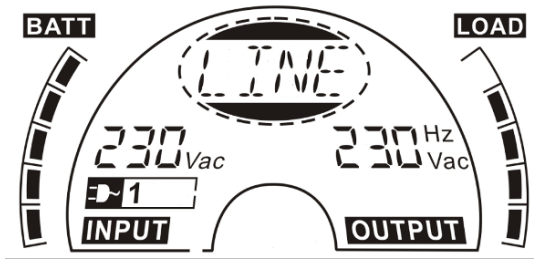

■ Figure 6.1 The Line mode

## 6.2 Battery mode

The LCD display in battery mode is shown as figure 6.2. The information about the battery voltage, the battery level, the UPS output and the load level will be displayed. The “bATT” string indicates UPS working in the battery mode. If the function of battery remain time is set to enable, the “bATT” string and battery remaining time (in unit Min or Sec) would display in turn every 2s.

When the UPS is running in battery mode, the buzzer beeps once every 4 seconds. If the “ON” button on the front panel is pressed for more than 1 second, the buzzer will stop beeping (in silence mode). Press the “ON” button once again for more than 1 second to resume the alarm function.

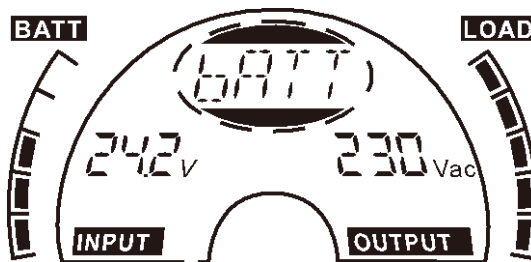

■ Figure 6.2 The Battery mode

### 6.3 Bypass mode

The LCD display in bypass mode is shown as figure6.3. The information about the mains power, the battery level, the UPS output and the load level will be displayed. The UPS will beep once every 2 minutes in bypass mode. The “bYPA” string indicates UPS working in the bypass mode

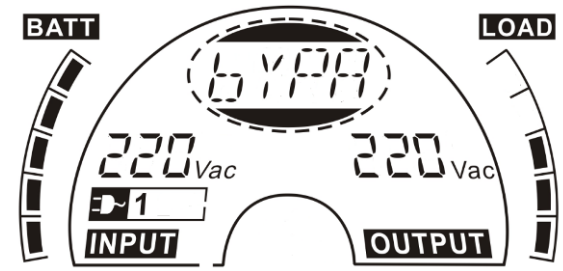

■ Figure 6.3 The Bypass mode

### 6.4 No Output mode

The LCD display in No output mode is shown as figure6.4. The information about the mains power, the battery level, the UPS output and the load level could be displayed. The “STbY” string indicates UPS working in the No output mode.

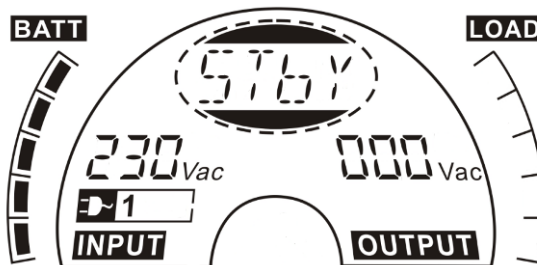

■ Figure 6.4 The No output mode



---

## 6.5 EPO (Emergency Power Off)

It is also called RPO (Remote Power Off). On LCD display, the word of “EPO” will be presented in the position of output voltage.

It is a special status which the UPS will shut the output off and send out alarm. The UPS cannot be turned off by pressing “OFF” button on the panel, only after resetting EPO status.

## 6.6 ECO mode (Economy mode)

It is also called high efficiency mode. After turning UPS on in ECO mode, the output power will be supplied from mains power directly via internal filter while the mains power is in certain range, so the high efficiency performance would be gained in ECO mode. Once the mains power is loss or out of range, the UPS will transfer to battery mode and the load will be supplied continuously by the battery.

- 1) ECO mode can be enabled through the LCD setting or the software (Winpower, etc.).
- 2) The transfer time of UPS output from ECO mode to battery mode is less than 10ms. It is suggested that takes account of application for some sensitive load.

## 6.7 CVCF mode

CVCF (Constant Voltage Constant Frequency) which is also called converter mode, UPS would works in frequency free-run with fixed output frequency (50Hz or 60Hz). Once the mains are loss or abnormal, the UPS would transfer to battery mode and the load is supplied continuously by the battery.

- 1) CVCF mode can be enabled through the LCD setting or the software (Winpower, etc.).
- 2) The normal power rating will be derating to 60% in converter mode.

## 6.8 Abnormal mode

In abnormal mode such as Bus fault etc., the corresponding fault string would be shown on LCD display to indicate the status of the UPS, and the background light will become red color. For example “SHOR” would be shown when the connected load or the UPS output is in short-circuited, the LCD display is shown as figure6.5 followings.



■ Figure 6.5 The Fault mode

## 7. Setting by LCD Module

The output voltage/frequency, Auto bypass status, operating mode in No output mode or Bypass mode, charger current, external Battery AH and battery remaining time function in all mode could be set directly through LCD module.

In bypass or no output mode, pressing the “Enter” button on the LCD panel for more than 1 second to enter setting mode. The LCD display is shown in the following figure7.1. The string “OPV” that stands for output voltage. “230Vac” indicates the existing output voltage is 230Vac. if you want to set output voltage, press the “Enter” button for more than 1 second, a flickering string “220” would be shown, if the “Enter” button is pressed again, the string “220” turn to flickerless, the output volt is changed to 220V; if the “Select” button is pressed for more than 1 second, the next flickering string “230” appear, the order of flickering string is 220 – 230 – 240 – 220 – 230,

Press “Enter” button to confirm the output volt what you want.

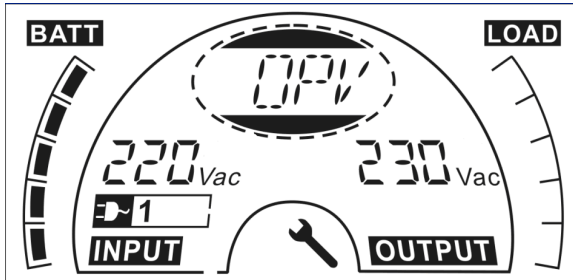

■ Figure 7.1 Setting by LCD

To exit the setting mode that requests a pressing once on the “Enter” button; to continue setting, press “Select” button. If no any pressing on the “Select” or “Enter” button lasting for more than 10 seconds, the setting mode will exit automatically.

The output frequency string “OPF”, Bypass status string ” bYPA”, operating mode string “MODe”, External Battery Ah string “EbAH”, battery remaining time string “bATT” , Charger current string”CHG” would be presented circularly. The only one voltage value can be selected in “220V”, “230V”, “240V” at any time; The only one frequency value can be selected in “50Hz”, “60Hz” at any time; Bypass status can be selected in “000” or “001”(Here 000 means Bypass Disable,001 means Bypass Enable),The UPS would turn to bypass mode in several seconds if “Bypass Enable” is selected, and turn to no output mode in several seconds if “Bypass Disable” is selected; Operating mode can be selected in “UPS”, “ECO”, “CVF”(Here “UPS” means the normal online mode, “ECO” means the high efficiency mode, and “CVF” means the converter mode), The mode change would be active only after the UPS is turned on; External Battery Ah could be selected from “005” to “300”(Here “005” means 5Ah total external battery); Charger Current could be selected 3.0/6.0 for 1KL T and 1.5/3.0/4.5/6.0 for 2KL/3KL T (Here 3.0 means 3A charger). The battery remaining time function could be selected in “000” or “001”. (Here 000 means battery remaining time function is disabled, then the battery remaining time could not display on LCD in

battery mode. 001 means battery remaining time function is enabled, then in battery mode or battery test mode the battery remaining time (in unit Min or Sec) and string “bATT” would display on LCD in turn every 2s).

- An example for changing the Operating mode from normal mode to converter mode through the LCD display.

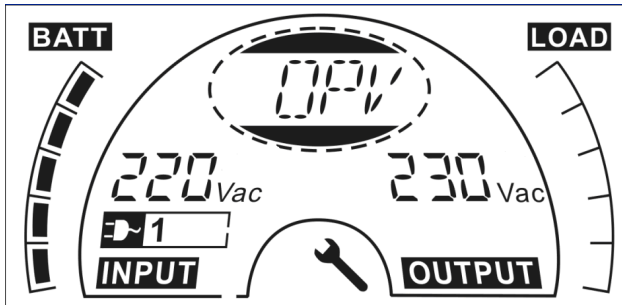

**Step 1:** “OPV” after pressing the “Enter” button.

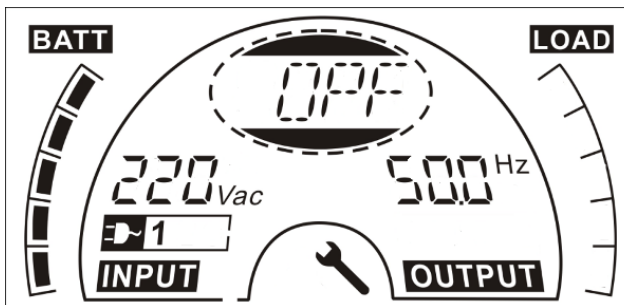

**Step 2:** “OPF” after pressing the “Select” button.

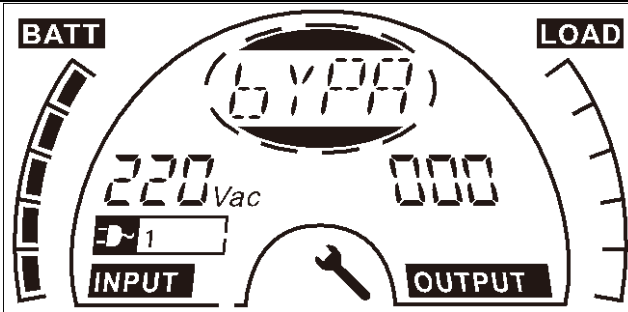

**Step 3:** “bYPA” after pressing the “Select” button.

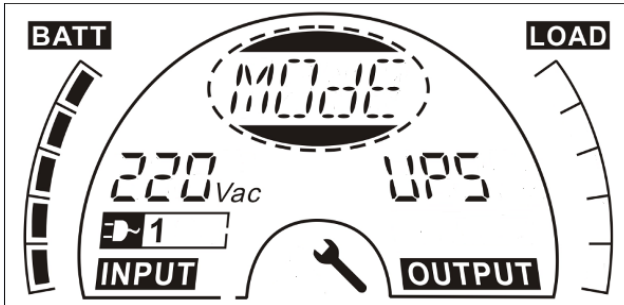

**Step 4:** “MODe” after pressing the “Select” button.  
“UPS” is flickering after pressing the “Enter” button.

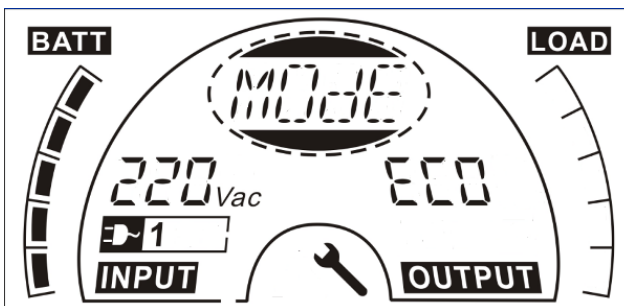

**Step 5:** “ECO” flickering after pressing the “Select” button.

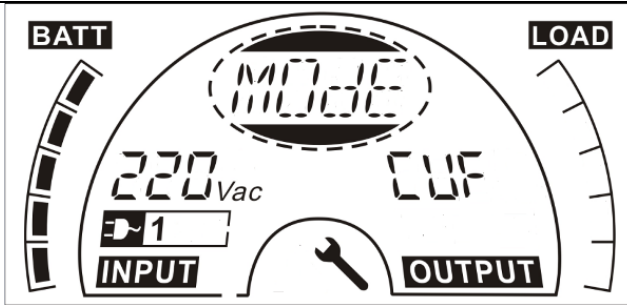

**Step 6:** “CVF” flickering after pressing the “Select” button. Press the “Enter” button  
Short touch “Enter” button exit setting mode.

## 8. Trouble Shooting

If the UPS system does not operate correctly, check the operating status on the LCD display. The Warning code or fault code is shown in Warning& Fault Code Table 6.1

If the UPS system does not operate correctly, please attempt to solve the problem using the table below.

Warning & Fault Code	Problem	Possible cause	Remedy
/	No indication, no warning tone even though system is connected to mains power supply	1) No input voltage 2) Breaker open	1) Check building wiring socket outlet and input cable. 2) Check the Breaker
/	No Communication data	1) RS232 wire is not matched 2) USB wire is not matched	1) check or change the RS232 wire 2) check or change the USB wire
/	Emergency supply period shorter than nominal value	1) Batteries not fully charged 2) Batteries defect	1) Charge the batteries until the Batteries are fully charged 2) Change the batteries or consult your dealer.
FANF	Fan fail	Fan abnormal	Check if the fan is running
HIGH	Battery over voltage	Battery is over charged	Switching to battery mode automatically,

			and after the battery voltage is normal and the mains is normal, the UPS would Switch to line mode automatically again.
bLOW	Battery low	Battery voltage is low	When audible alarm sounding every second, battery is almost empty.
bOPN	Battery open	Battery pack is not connected correctly	Do the battery test to confirm. Check the battery bank is connected to the UPS. Check the battery breaker is turn on.
CHGF	Charge fail	The charge is broken	Notify dealer.
dCHF	Digital bigger charger fail	The charge is broken	Notify dealer.
bUSH	Bus high	UPS internal fault	Notify dealer
bUSL	Bus low	UPS internal fault	Notify dealer
bSFT	Bus soft start fail	UPS internal fault	Notify dealer
bUSS	Bus short	UPS internal fault	Notify dealer
TEPH	Inverter temperature high	Inside temperature of the UPS is too high	Check the ventilation of the UPS, check the ambient temperature.
ITPH	Inner Ambient temperature high	The ambient temperature is too high	Check the environment ventilation.
INVH	Inverter high	UPS internal fault	Notify dealer
INVL	Inverter low	UPS internal fault	Notify dealer
ISFT	Inverter soft start fail	UPS internal fault	Notify dealer
NTCO	Inverter NTC open	UPS internal fault	Notify dealer



SHOR	Inverter short	Output short circuit	Remove all the loads. Turn off the UPS. Check whether the output of UPS and loads is short circuit. Make sure the short circuit is removed, and the UPS has no internal faults before turning on again.
OVTP	Over temperature fault	Over temperature	Check the ventilation of the UPS, check the ambient temperature and ventilation.
OVL	Overload	Overload	Check the loads and remove some non-critical loads. Check whether some loads are failed.
SITE	Site fail	Phase and neutral conductor at input of UPS system are reversed	Rotate mains power socket by 180° or connect UPS system.
EPO	EPO active	EPO function is enabled	Plug into the EPO switch.

Please have the following information at hand before calling the After-Sales Service Department:

1. Model number, serial number
2. Date on which the problem occurred
3. LCD display status, Buzzer alarm status
4. Utility power condition, load type and capacity, environment temperature, ventilation condition
5. The information (battery capacity, quantity) of external battery pack
6. Other information for complete description of the problem

---

## **9. Maintenance**

### **9.1 Operation**

The UPS system contains no user-serviceable parts.

### **9.2 Storage**

If the batteries are stored in temperate climatic zones, it is recommended to recharge those batteries every three months for 1~2 hours. It is highly suggested to shorten the recharging intervals in every two months at locations where subjects to high temperatures.

## 10. Technical Data

### 10.1 Electrical specifications

INPUT						
Model No.	1000 TG	1000 TGS	2000 TG	2000 TGS	3000 TG	3000 TGS
Phase	Single					
Frequency	40~70 Hz					
Current(A)	220/230/240VAC					
	4.9/4.7/4.5A	5.7/5.4/5.2A	9.7/9.3/8.9A	9.7/9.3/8.9A	14.5/13.9/13.3A	14.5/13.9/13.3A

OUTPUT			
Model No.	VFI 1000 TG (S)	VFI 2000 TG(S)	VFI 3000 TG(S)
Power rating*	1kVA/0.9kW	2kVA/1.8kW	3kVA/2.7kW
Voltage	220Vac/230Vac/240Vac		
Frequency	50/60Hz		
Wave form	sinusoidal		

**\*Note: the active power is defined in rated voltage input**

BATTERIES						
Model No.	1000 TG	1000 TGS	2000 TG	2000 TGS	3000 TG	3000 TGS
Voltage	24V	24V	48V	48V	72V	72V
Capacity	9Ah	5Ah~120Ah*	9Ah	5Ah~120Ah*	9Ah	5Ah~120Ah*

\*Note : the Capacity of external batteries can be set to 300Ah maximum but it may need more time to fully charge the batteries.

### 10.2 Operating Environment

Ambient Temperature	0 °C to 40 °C
Operating humidity	< 95%
Altitude	< 1000m <sup>(Note 1)</sup>
	1000m < Altitude ≤ 3000m <sup>(Note 2)</sup>
Storage temperature	-25°C~55°C

Note 1: the load no derating

Note 2: the load should derating 1 % for every up 100m

### 10.3 Typical backup time (values at 25°C in minutes)

Model No.	100 % Load	50 % Load
VFI 1000 TG	3'30"	10'30"
VFI 1000 TGS	16'30" (Base on 1EBM)	45'00"(Base on 1EBM)
VFI 2000 TG	3'30"	10'30"
VFI 2000 TGS	16'30" (Base on 1EBM)	45'00"(Base on 1EBM)
VFI 3000 TG	4'00"	11'30"
VFI 3000 TGS	11'00"(Base on 1EBM)	28'00"(Base on 1EBM)

### 10.4 Dimensions and weights

Model No.	Dimensions W×H×D (mm)	Net Weight (kg)
VFI 1000 TG	144*229*345	9.3Kg
VFI 1000 TGS	102*229*345	3.7Kg
VFI 2000 TG	190*330*393	22.2Kg
VFI 2000 TGS	102*330*393	5.4Kg
VFI 3000 TG	190*330*393	22.2Kg
VFI 3000 TGS	102*330*393	5.4Kg

---

## **11. Communication Port**

On the rear panel of the UPS (see Appendix), USB connector is standard, RS232 connector and Slot for optional connectivity cards are optional.

### **11.1 USB and RS-232(Optional) Communication Ports**

To establish communication between the UPS and a computer by use an appropriate communication cable.

### **11.2 USB for HID power device**

The USB interface offers feature “smart battery” which supports HID (Human Interface Device) Power Device Class, no more software installation is needed. Computer’s OS (Operating System) such as Windows/Linux/Mac OS comes with an embedded power management and monitoring function. When such computer connects to UPS via USB cable, the UPS will be automatically recognized by the OS as a “HID UPS Battery”, and user can configure the alarm action in the event of low battery, such as shutting down the computer automatically. UPS with this feature is also ideal as a back-up power for NAS (Network-Attached Storage).

### **11.2 AS400 Interface (Optional)**

It owns isolated dry contact relay outputs for UPS status: such as Mains/Utility failure, Battery low, UPS alarm/OK, or on Bypass and so on. To see more detail about the interface definitions please check the AS400 user manual.

### **11.1 CMC Interface (Optional)**

It provides connection to Modbus protocol with standard RS485 signal. To see more detail please check the CMC user manual.

### **11.2 NMC Interface (Optional)**

NMC (Network Management Card) allows the UPS to communicate in a variety of networking environments and with different types of devices. NMC achieves a remote management for the UPS through internet/intranet. Please contact your local dealer for further information. To see more detail please check the NMC user manual

## 12. Software

### Software Download – WinPower

PowerWalker WinPower is a UPS monitoring software, which provides user-friendly interface to monitor and control your UPS. This unique software provides safely auto shutdown for multi-computer systems while power failure. With this software, users can monitor and control any UPS on the same LAN no matter how far from the UPSs.

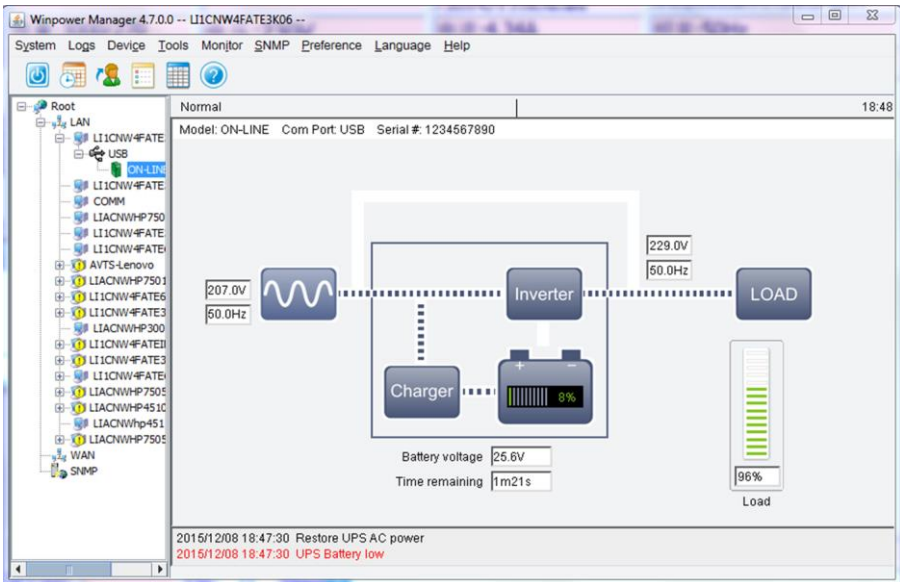

### Installation procedure:

1. Go to the website: <http://winpower.powerwalker.com/>
2. Choose the operation system you need and follow the instruction described on the website to download the software.
3. When downloading all required files from the internet, enter the serial No: **511C1-01220-0100-478DF2A** to install the software.

When your computer restarts, the WinPower software will appear as a green plug icon located in the system tray, near the clock.

## Appendix: Rear panel

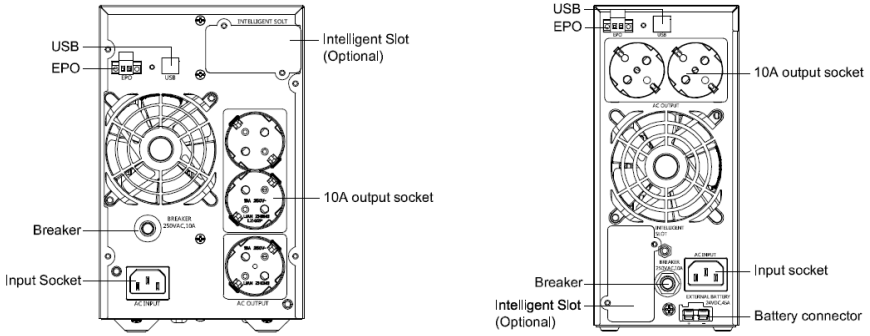

1000 TG(S) Back View of Schuko

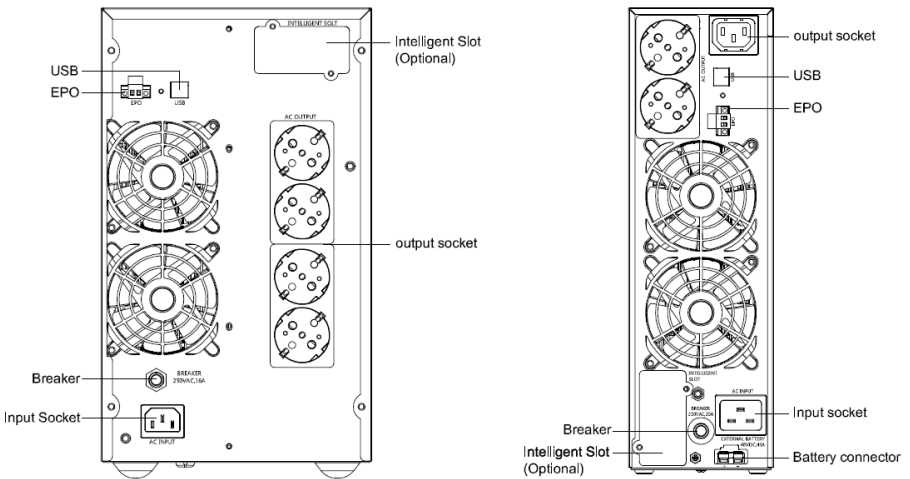

2000 TG(S) Back View of Schuko

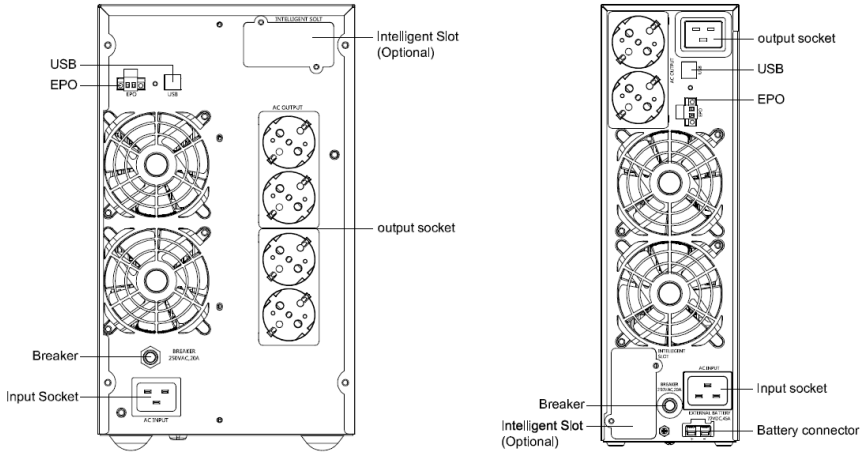

**3000 TG(S) Back View of Schuko**

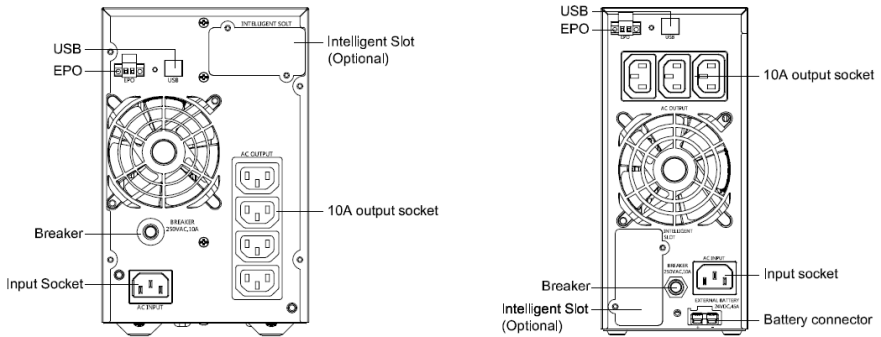

**1000 TG(S) Back View of IEC**



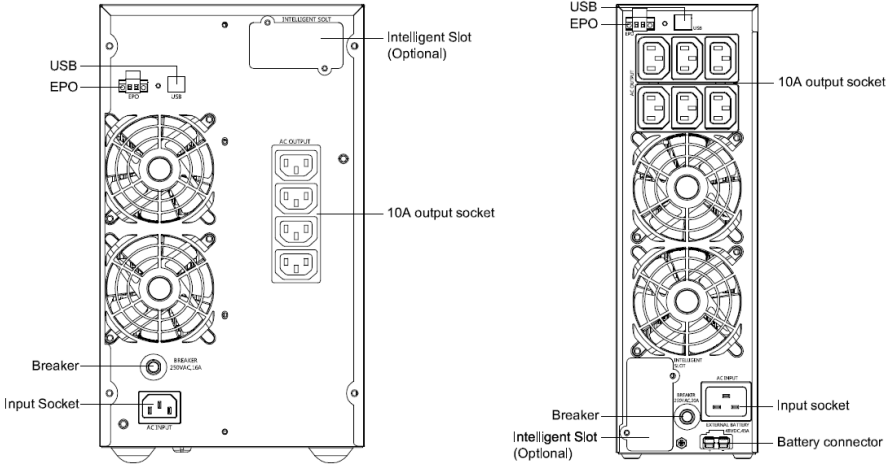

**2000 TG(S) Back View of IEC**

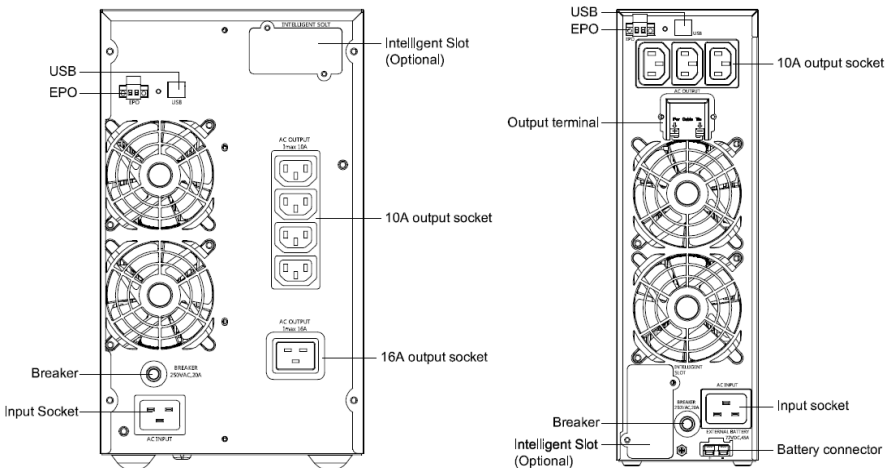

**3000 TG(S) Back View of IEC**