

BIXOLON®

Windows Driver Manual
SRP-F312II

Thermal printer
Rev. 1.00

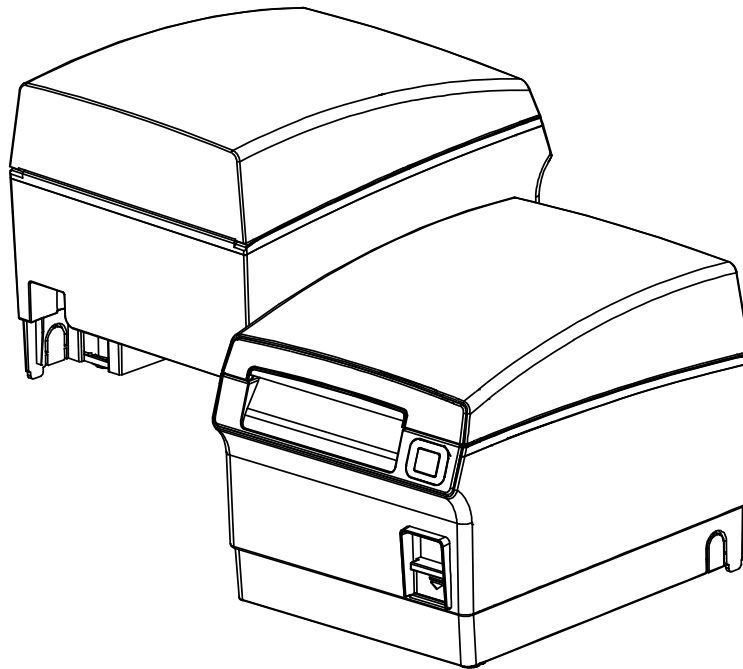

<http://www.bixolon.com>

■ Table of Contents

1. Manual Information	3
2. Operating System (OS) Environment	3
3. Windows Driver Preparation	3
4. Windows Driver Installation	4
4-1 Installing on Windows XP / Server 2003.....	4
4-1-1 Via Serial Port, Parallel Port or Bluetooth.....	4
4-1-2 Via USB Port.....	7
4-1-3 Via Ethernet / Wireless LAN Port.....	9
4-2 Installing on Windows VISTA / Server 2008 / 7 / 8 / Server 2012 / 10.....	12
4-2-1 Via Serial Port, Parallel Port or Bluetooth.....	12
4-2-2 Via USB Port.....	15
4-2-3 Via Ethernet / Wireless LAN Port.....	17
5. Windows Driver Settings	20
5-1 Layout.....	20
5-1-1 Paper Size.....	21
5-1-2 Paper Type.....	22
5-1-3 Copies.....	23
5-1-4 Image Rotation.....	23
5-1-5 Paper Reduction.....	23
5-1-6 Crop Function.....	23
5-1-7 Orientation.....	23
5-2 Document Settings.....	24
5-2-1 Send Command.....	25
5-2-2 Cash Drawer / Internal Beep.....	25
5-2-3 Line Feed.....	25
5-2-4 Cut.....	25
5-3 NV Image.....	26
5-4 Barcode.....	27
5-4-1 1d Barcodes.....	28
5-4-2 2d Barcodes.....	29
5-5 Dithering.....	30
5-6 Utility.....	31
5-6-1 Unified POS Utility.....	32
5-6-2 Special Font Edit Utility.....	32
5-6-3 Journal Viewer.....	33
5-6-4 Text-Key Function.....	34
5-6-5 Preview.....	37
5-7 Bidirectional Communication.....	38
6. Windows Driver Specifications	39
6-1 Font.....	39
6-2 Special functions.....	41
7. Use of Windows Driver	43
7-1 Use of Visual Basic.....	43
7-1-1 Windows Driver Selection.....	43
7-1-2 Text Printing.....	43
7-1-3 Barcode Printing.....	44
7-2 Use of WordPad.....	45
7-2-1 WordPad Environment Settings.....	45
7-2-2 Text Printing.....	45

1. Manual Information

This Windows Driver Installation Manual provides information on installation, detailed specifications, and usage of the printer's Windows Driver according to PC operating system (OS).

We at BIXOLON maintain ongoing efforts to enhance and upgrade the functions and quality of all our products. In following, product specifications and/or user manual content may be changed without prior notice.

2. Operating System (OS) Environment

The following operating systems are supported for usage.

- Microsoft® Windows XP SP3 (32bit)
- Microsoft® Windows XP SP1 or later (64bit)
- Microsoft Windows Server 2003 SP1 or later (32bit/64bit)
- Microsoft Windows VISTA (32bit/64bit)
- Microsoft Windows Server 2008 (32bit/64bit)
- Microsoft Windows Server 2008R2 (64bit)
- Microsoft Windows 7 (32bit/64bit)
- Microsoft Windows 8 (32bit/64bit)
- Microsoft Windows Server 2012 (64bit)
- Microsoft Windows 10 (32bit/64bit)

3. Windows Driver Preparation

The Windows Driver is included in the enclosed CD, and Latest file versions can be downloaded from the BIXOLON website. (www.bixolon.com)

4. Windows Driver Installation

4-1 Installing on Windows XP / Server 2003

4-1-1 Via Serial Port, Parallel Port or Bluetooth

- 1) Double-click the Windows Driver installation file.
- 2) Click **Next**.

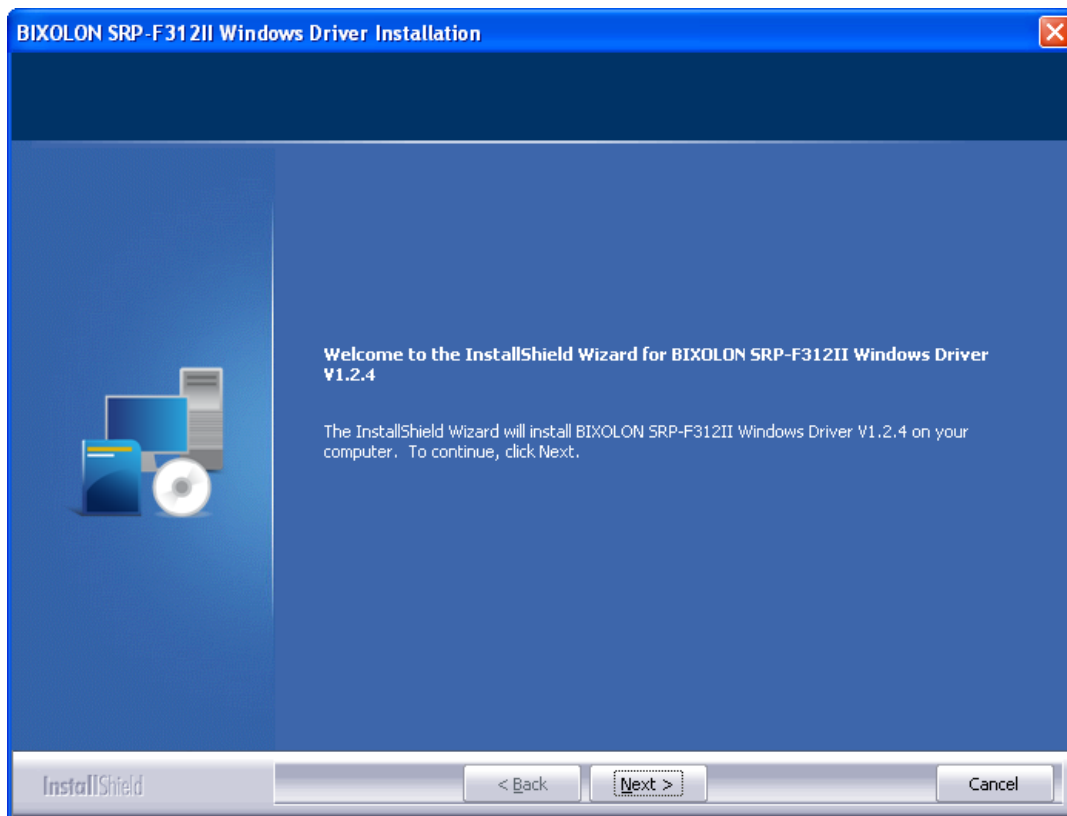

- 3) Select a COM or LPT port to be used, and then click **Next**.

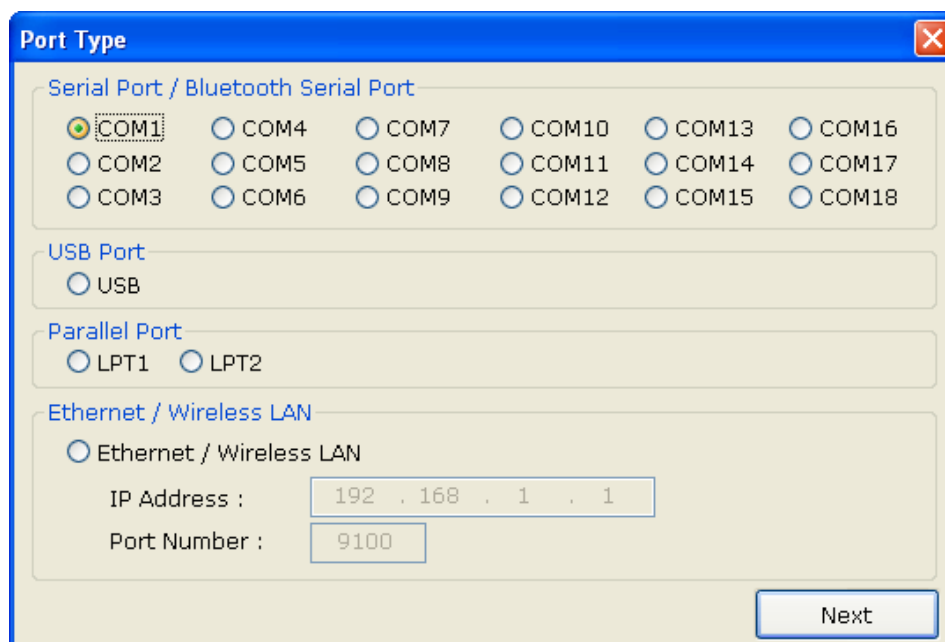

4) Click **Yes** to reboot the PC.

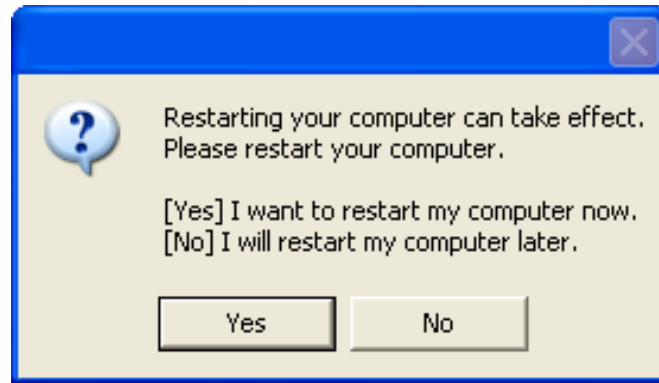

5) Open the printer properties window in the Windows OS.

※ Control Panel – Printers and Faxes.

6) In the **Ports** tab, click **Configure Port**.

※ Skip this step in case of data communication using Bluetooth or Parallel cable.

7) Match the communication settings to those of the printer. The communication settings of the printer can be performed by conducting a self-test.

※ Skip this step in case of data communication using Bluetooth or Parallel cable.

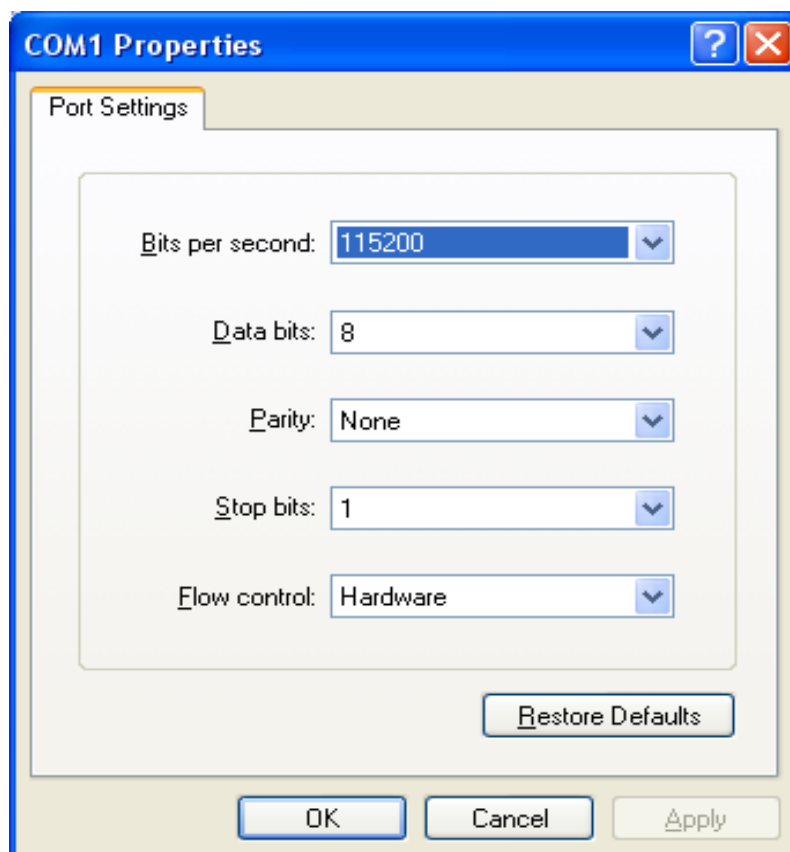

8) Click **Print Test Page** and check printing status. Proper installation of the driver is indicated if the test page is printed normally.

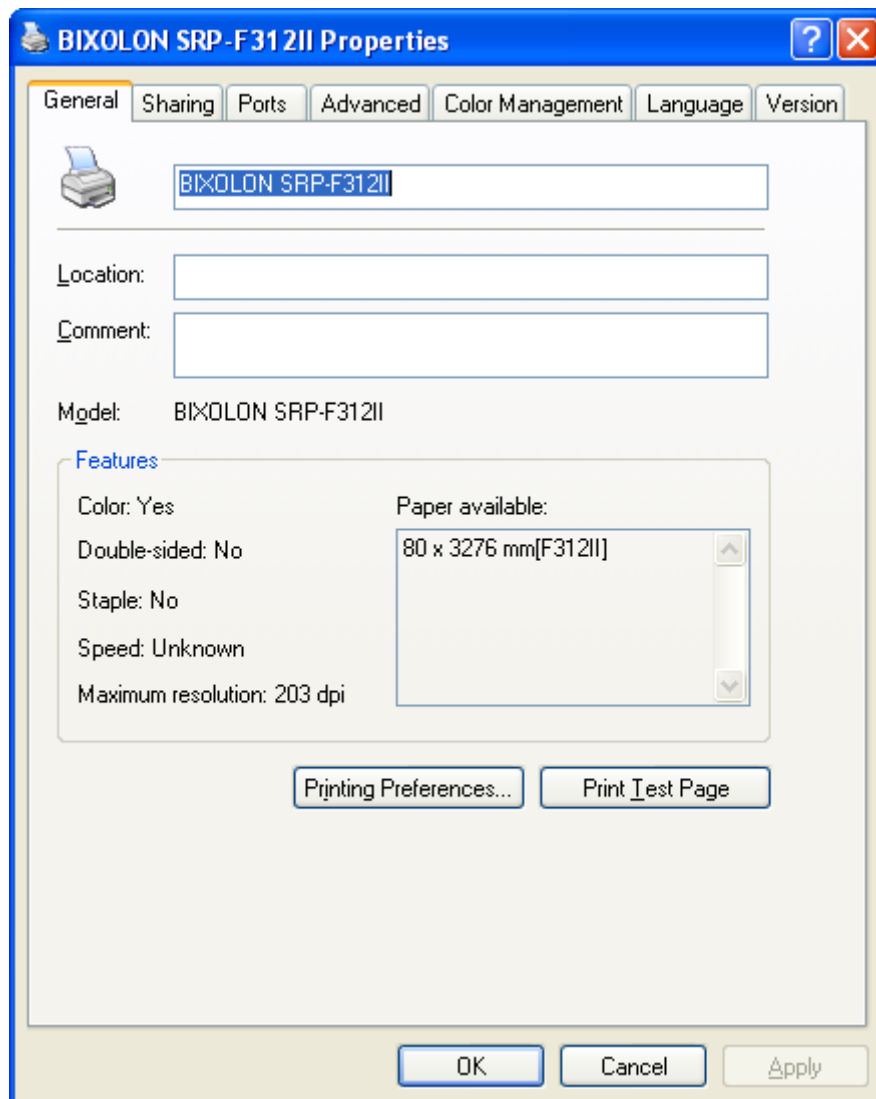

4-1-2 Via USB Port

- 1) Double-click the Windows Driver installation file.
- 2) Click **Next**.

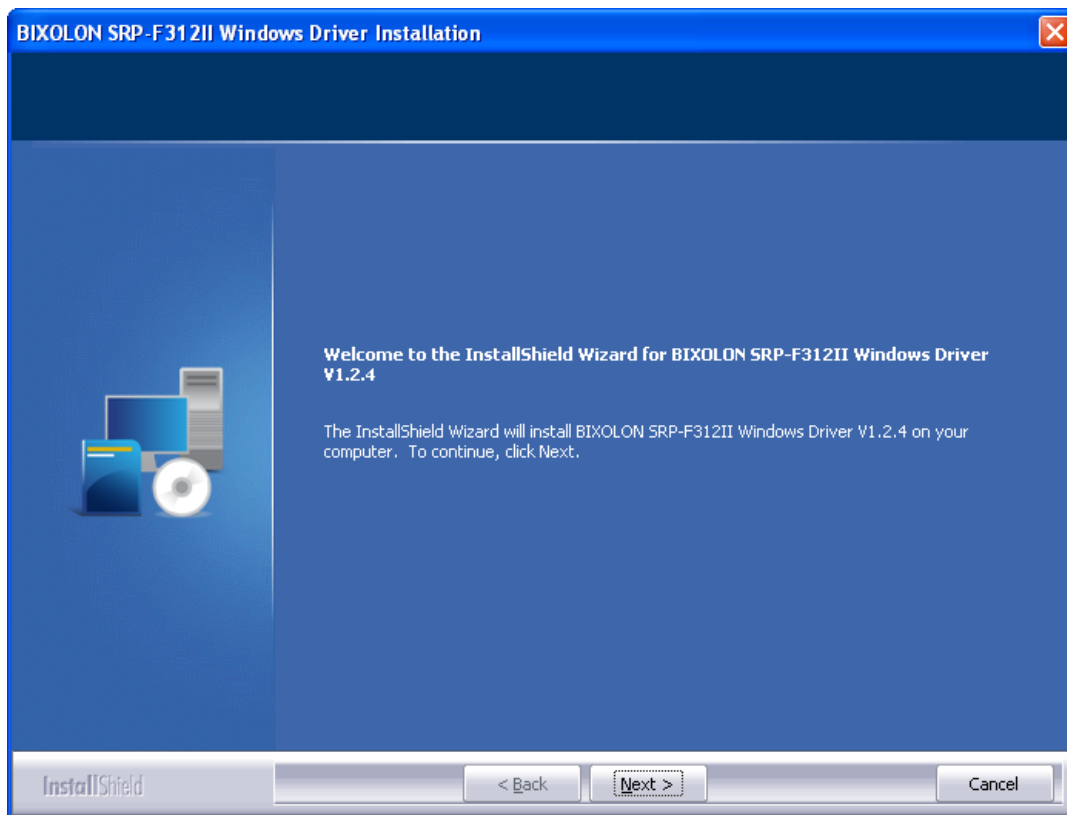

- 3) Select **USB** and then click **Next**.

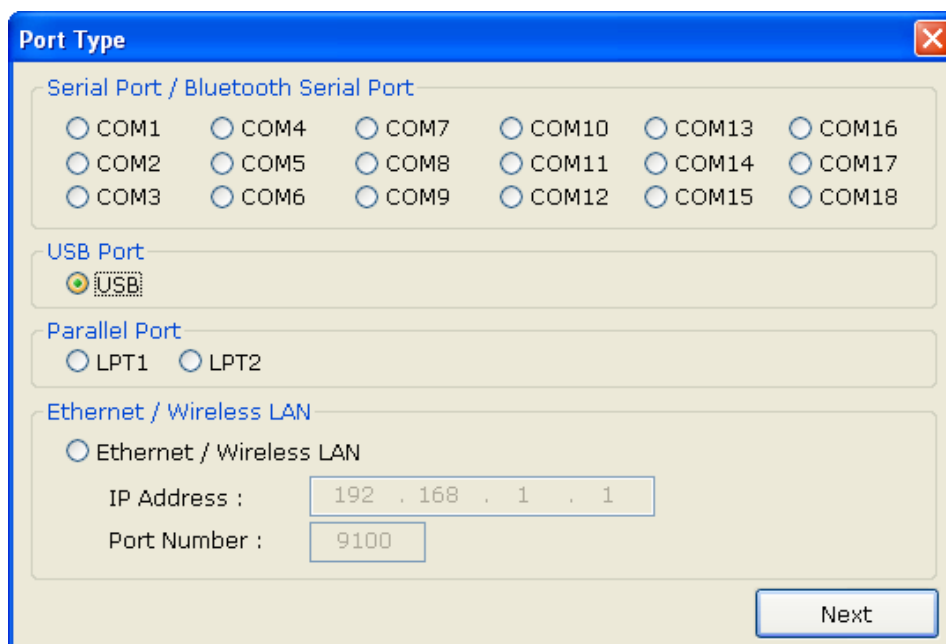

4) Click **OK**.

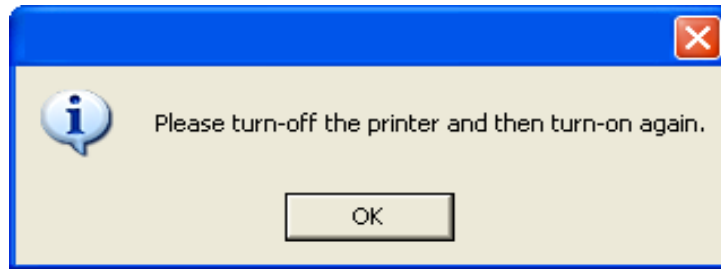

5) Turn off the printer and then turn it on. The printer driver will be installed automatically.

6) Open the printer properties window in the Windows OS.

※ Control Panel – Printers and Faxes.

7) Click **Print Test Page** and check printing status. Proper installation of the driver is indicated if the test page is printed normally.

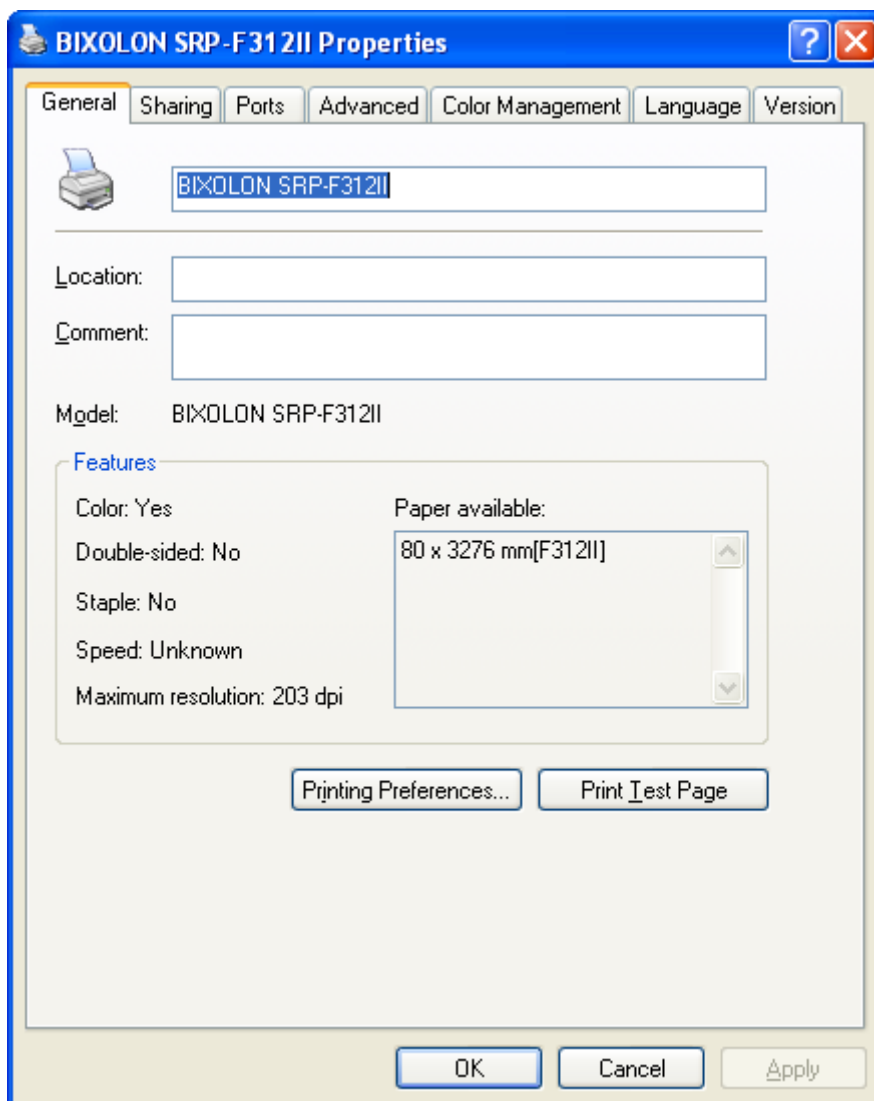

4-1-3 Via Ethernet / Wireless LAN Port

- 1) Double-click the Windows Driver installation file.
- 2) Click **Next**.

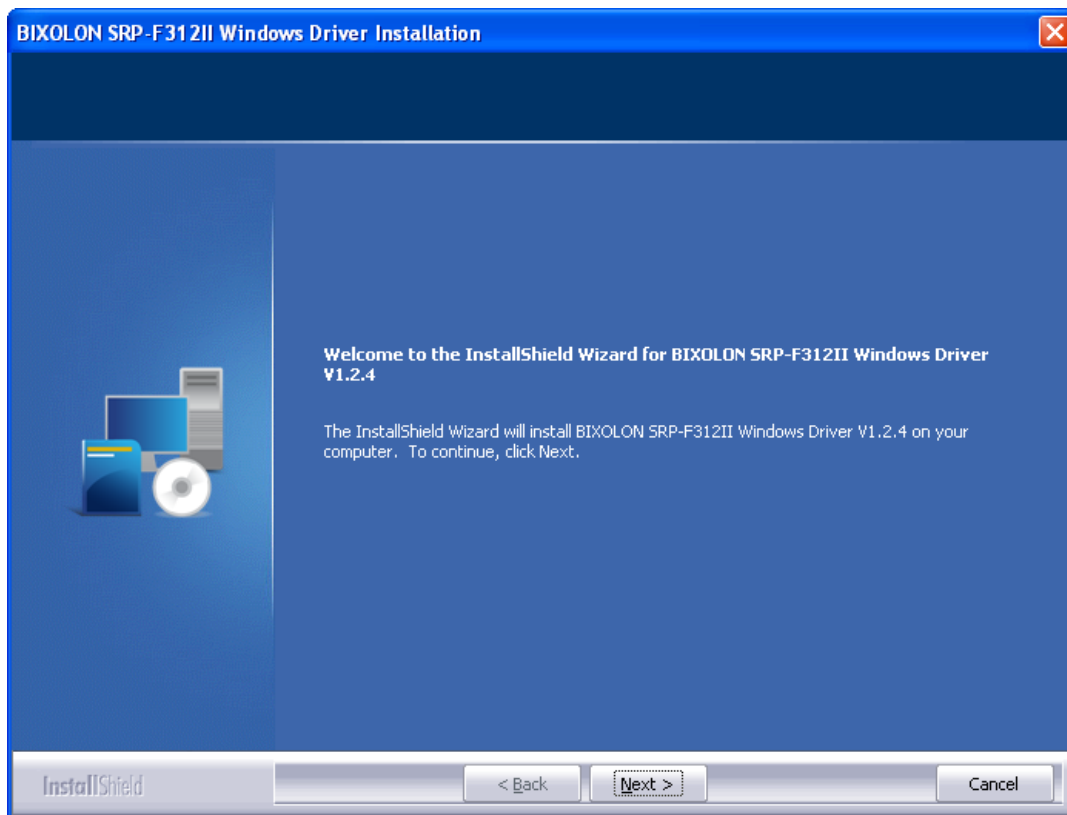

- 3) Select **Ethernet / Wireless LAN**.
- 4) Enter the IP address and port number, and then click **Next**.

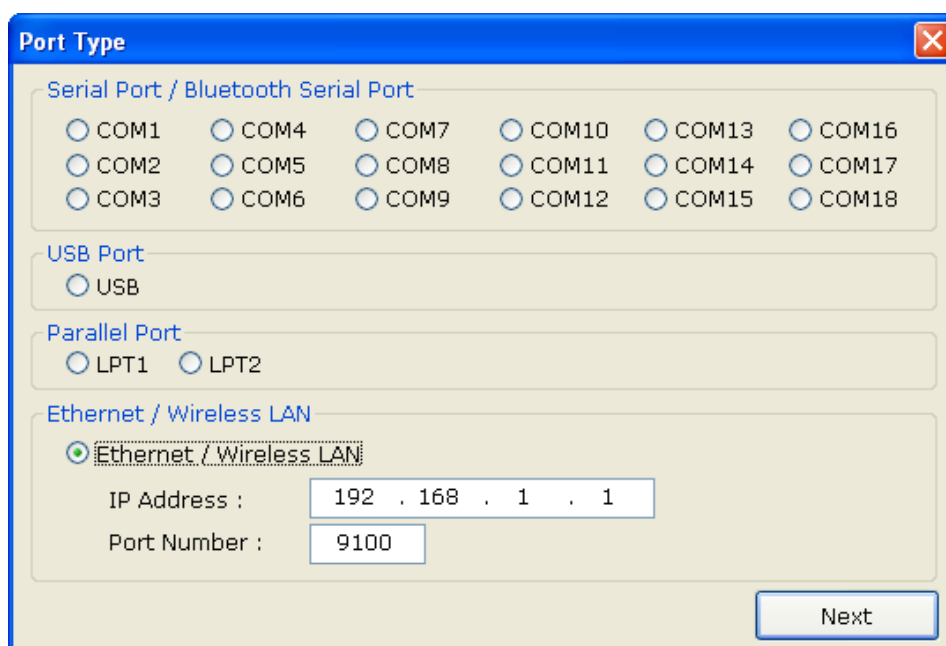

5) Click **Yes** to reboot the PC.

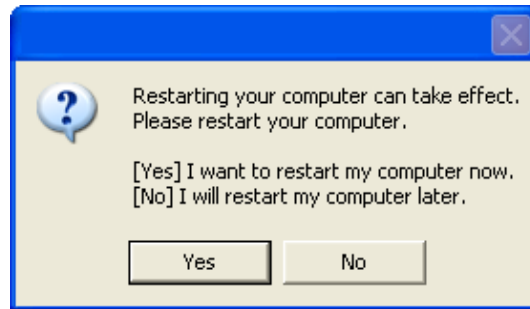

6) Open the printer properties window in the Windows OS.

※ Control Panel – Printers and Faxes.

7) In the **Ports** tab, click **Configure Port....**

8) Match the communication settings to those of the printer.

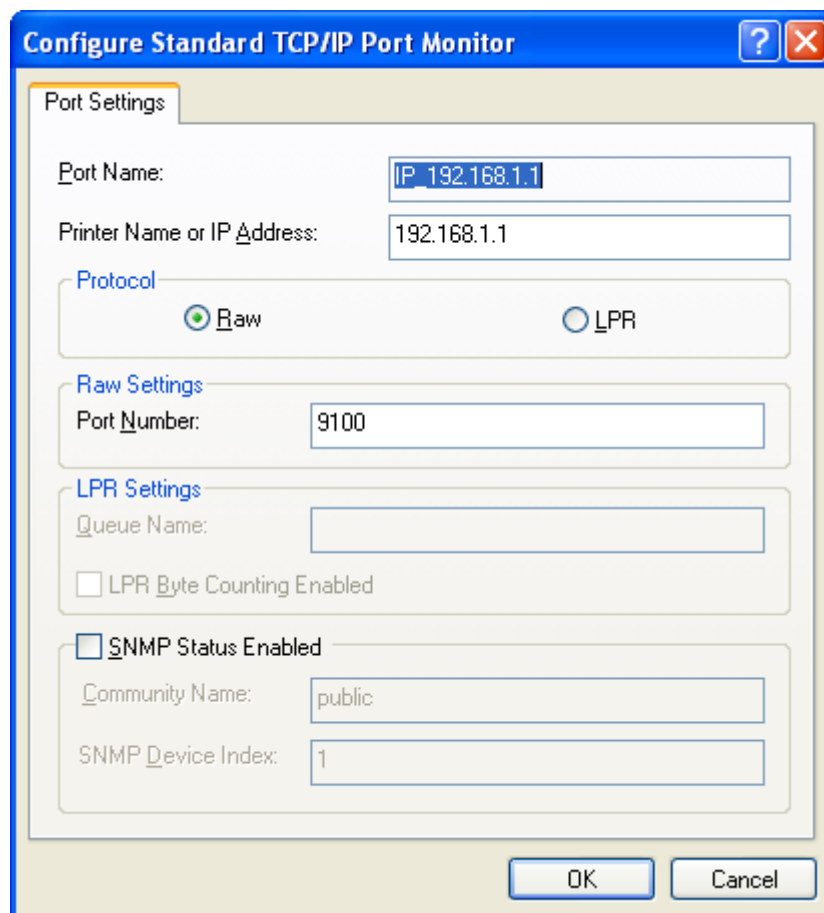

- 9) Click **Print Test Page** and check printing status. Proper installation of the driver is indicated if the test page is printed normally.

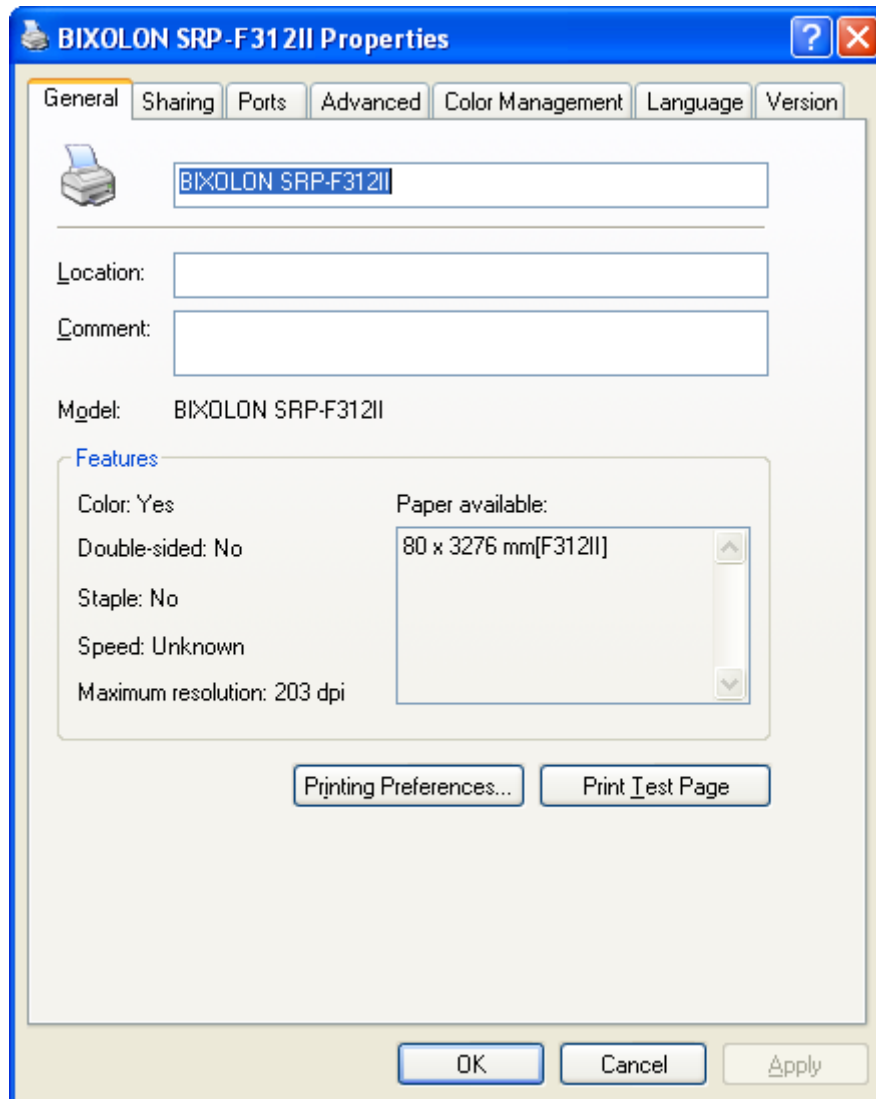

4-2 Installing on Windows VISTA / Server 2008 / 7 / 8 / Server 2012 / 10

4-2-1 Via Serial Port, Parallel Port or Bluetooth

- 1) Double-click the Windows Driver installation file.
- 2) Click **Next**.

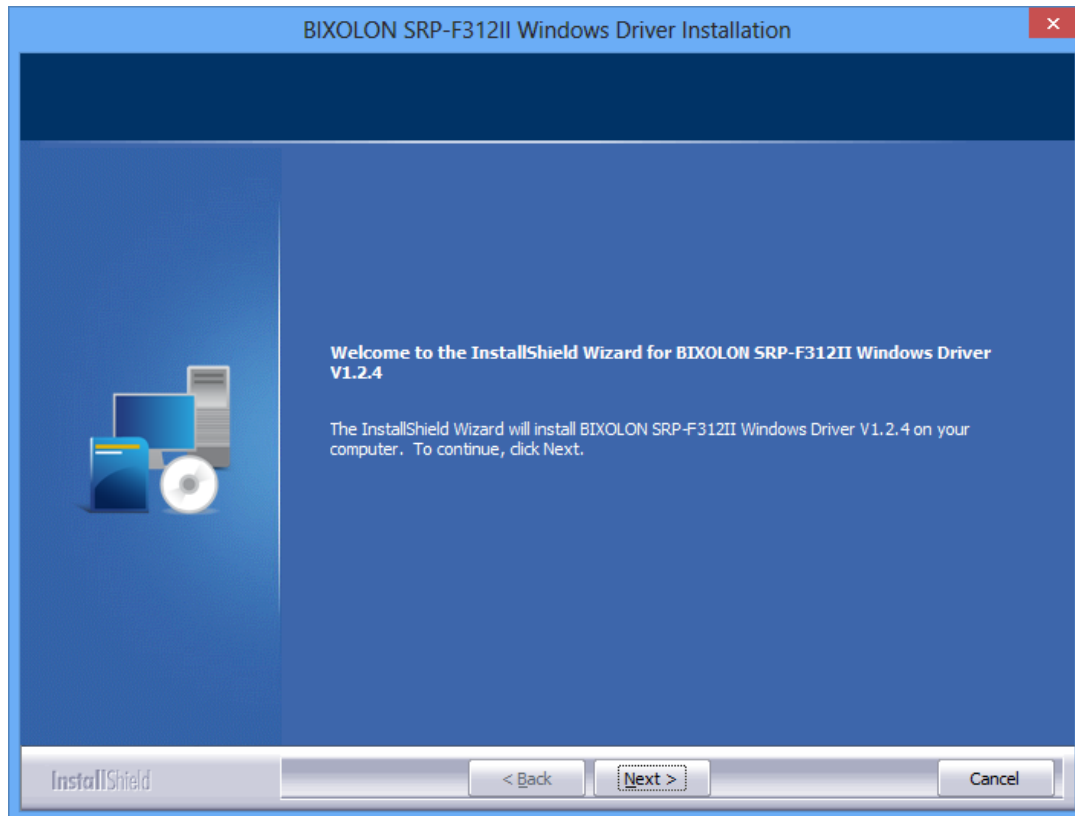

- 3) Select a COM or LPT port to be used, and then click **Next**.

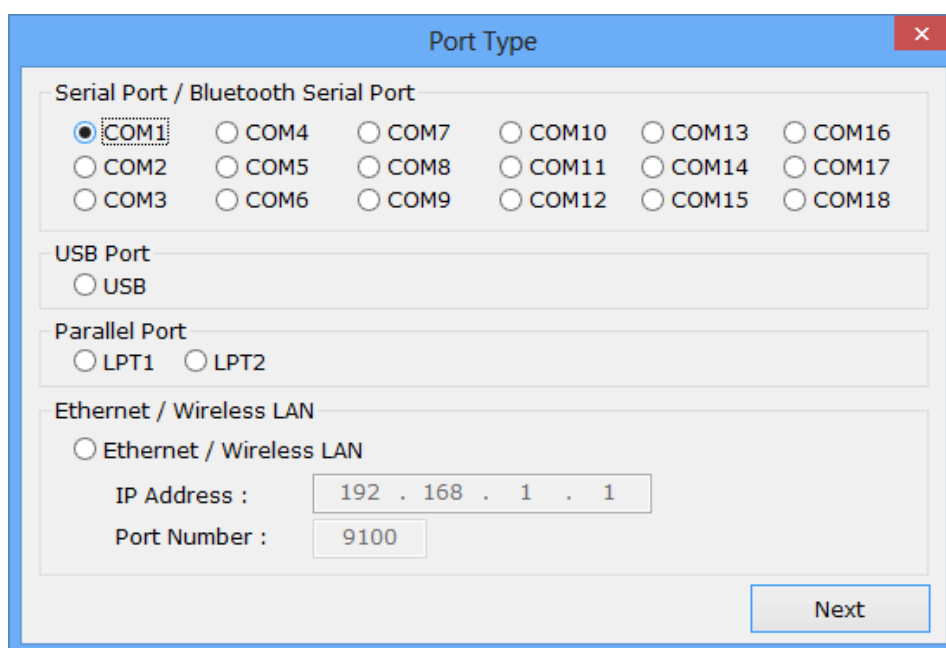

4) Click **Yes** to reboot the PC.

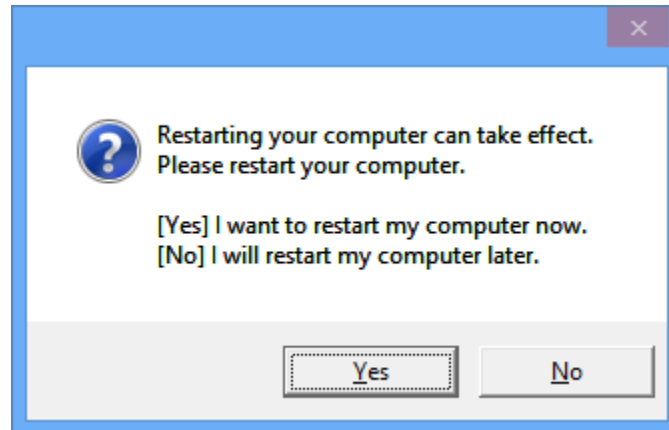

5) Open the printer properties window in the Windows OS.

※ Control Panel – Hardware and Sound – Device and Printers.

6) In the **Ports** tab, click **Configure Port**.

※ Skip this step in case of data communication using Bluetooth or Parallel cable.

7) Match the communication settings to those of the printer. The communication settings of the printer can be performed by conducting a self-test.

※ Skip this step in case of data communication using Bluetooth or Parallel cable.

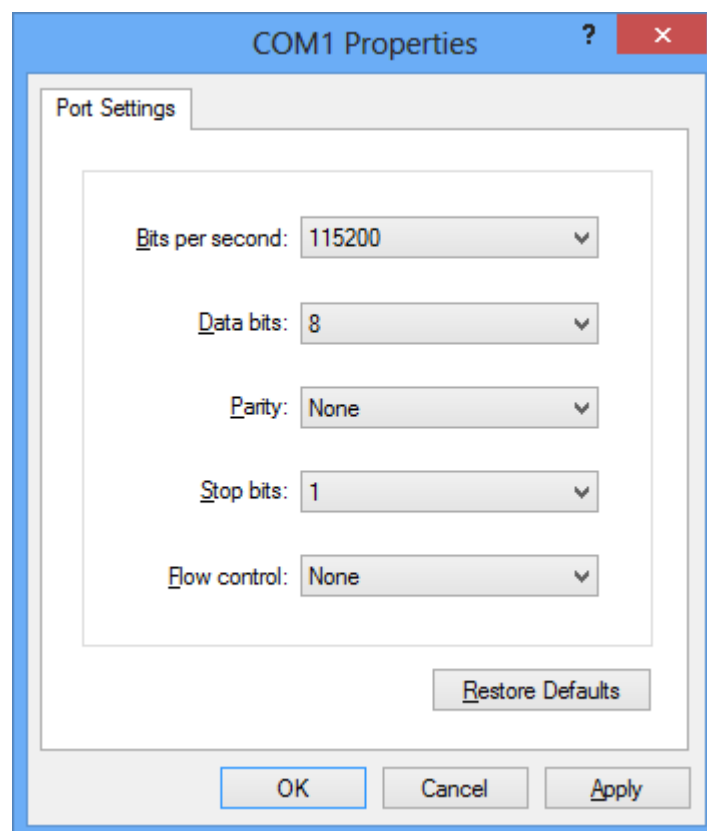

8) Click **Print Test Page** and check printing status. Proper installation of the driver is indicated if the test page is printed normally.

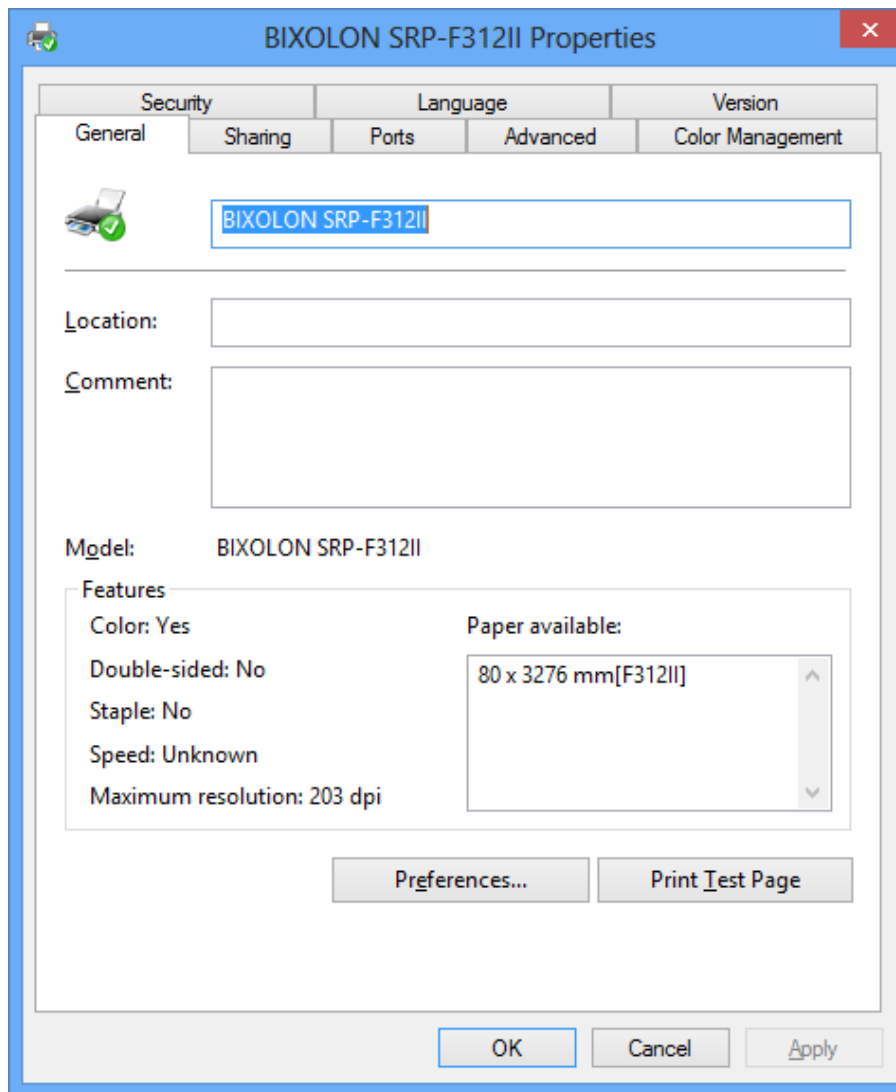

4-2-2 Via USB Port

- 1) Double-click the Windows Driver installation file.
- 2) Click **Next**.

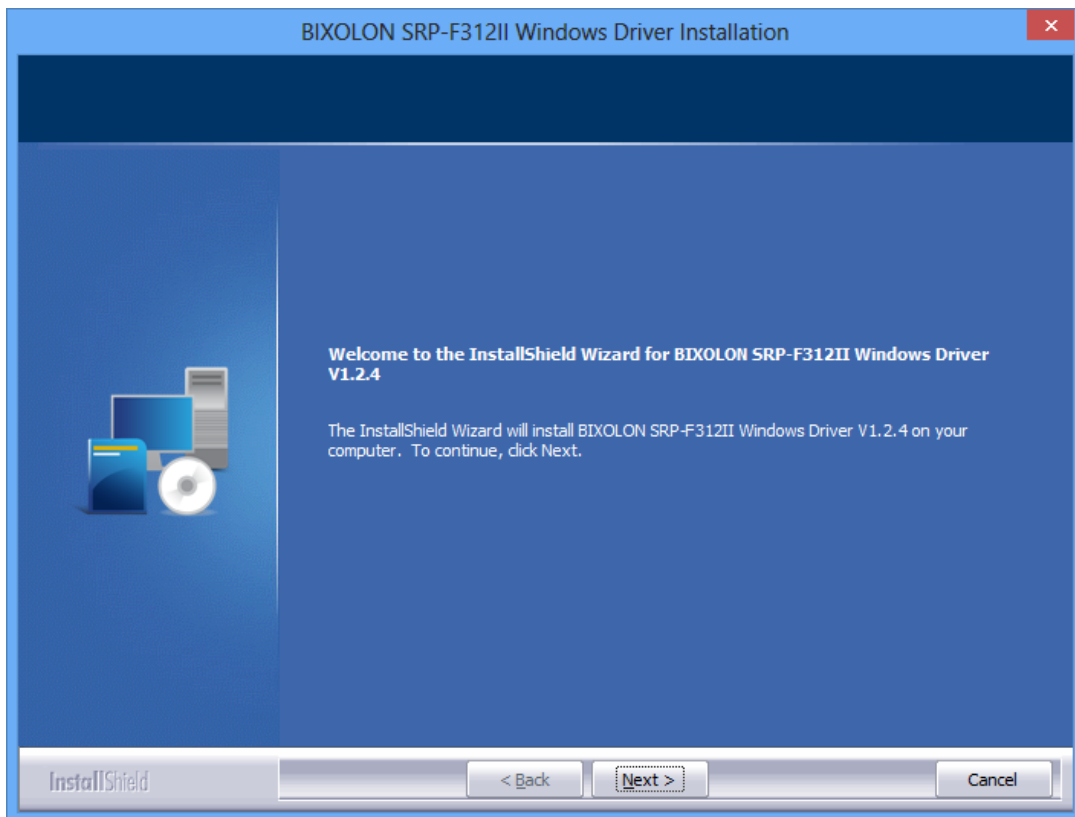

- 3) Select **USB** and then click **Next**.

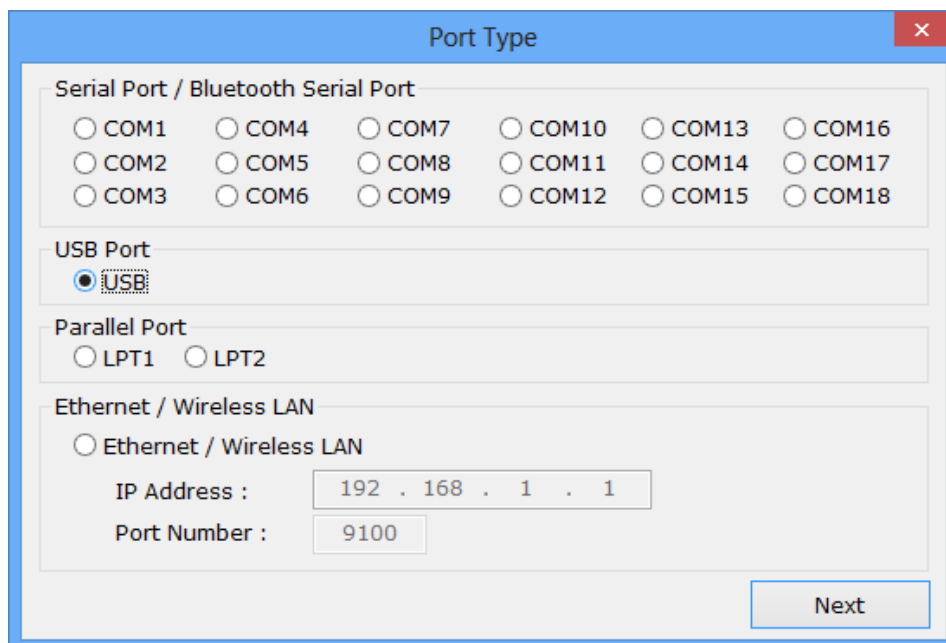

4) Click **OK**.

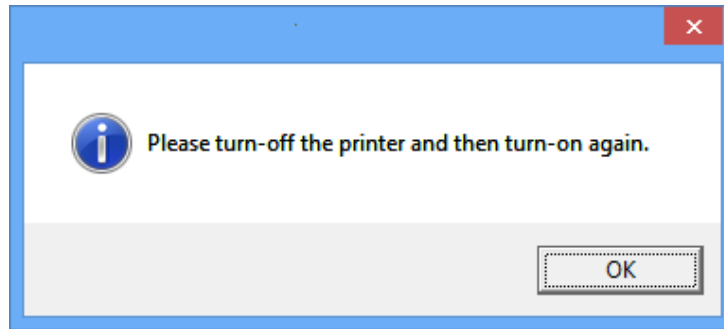

5) Turn off the printer and then turn it on. The printer driver will be installed automatically.

6) Open the printer properties window in the Windows OS.

※ Control Panel – Hardware and Sound – Device and Printers.

7) Click **Print Test Page** and check printing status. Proper installation of the driver is indicated if the test page is printed normally.

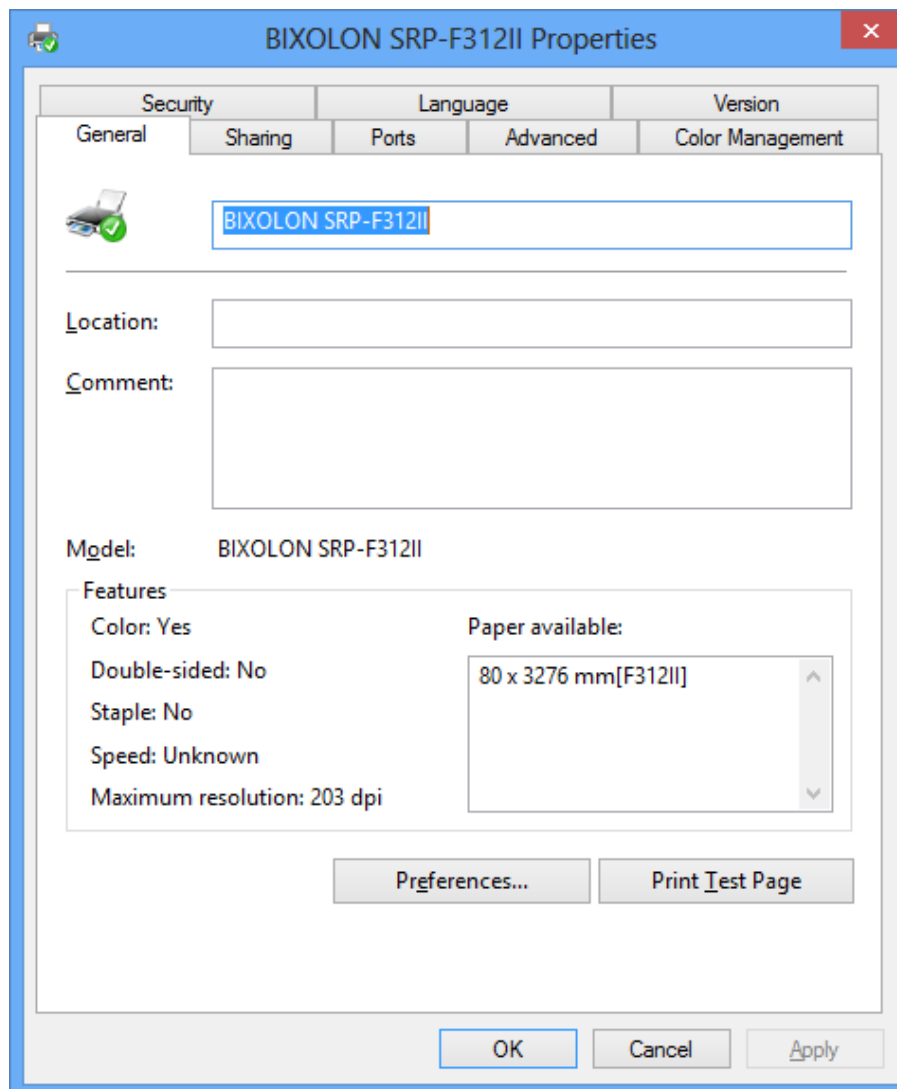

4-2-3 Via Ethernet / Wireless LAN Port

- 1) Double-click the Windows Driver installation file.
- 2) Click **Next**.

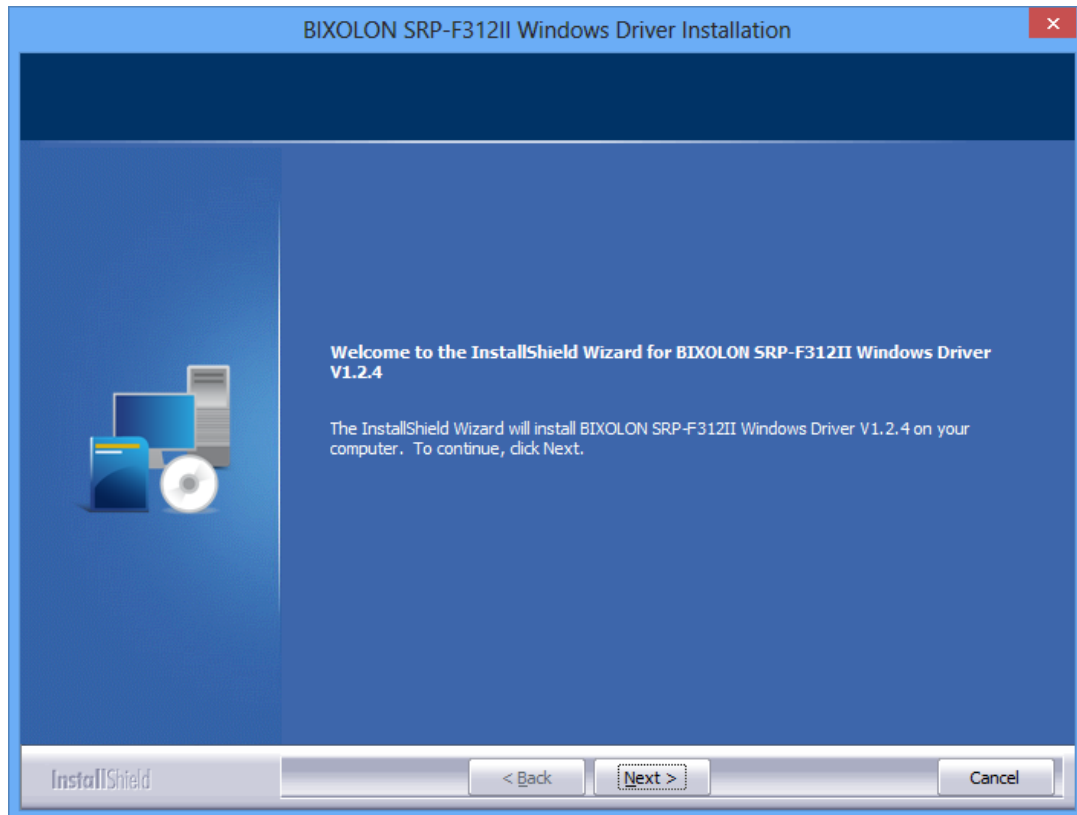

- 3) Select **Ethernet / Wireless LAN**.
- 4) Enter the IP address and port number, and then click **Next**.

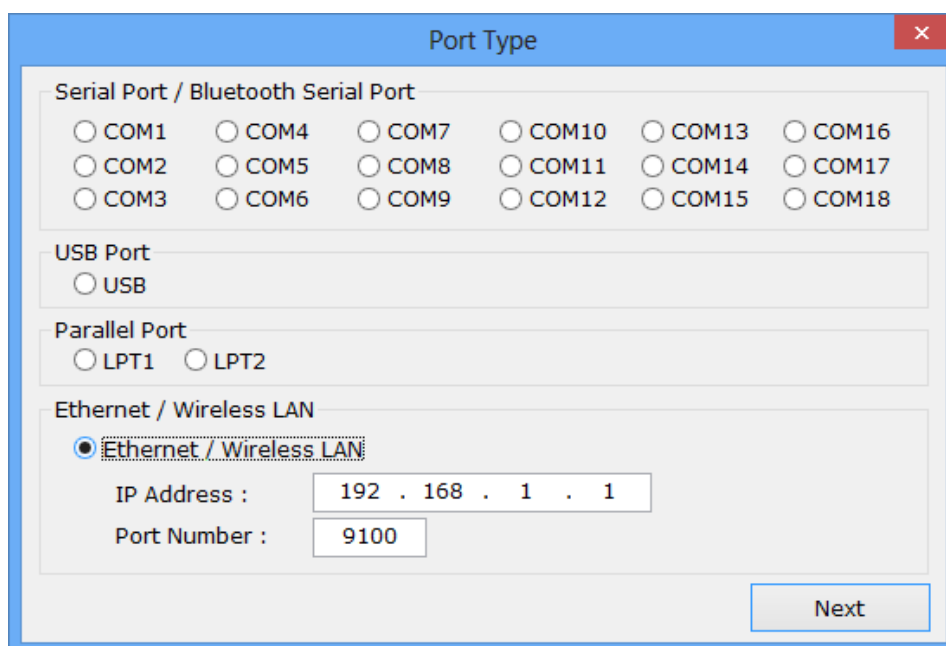

5) Click **Yes** to reboot the PC.

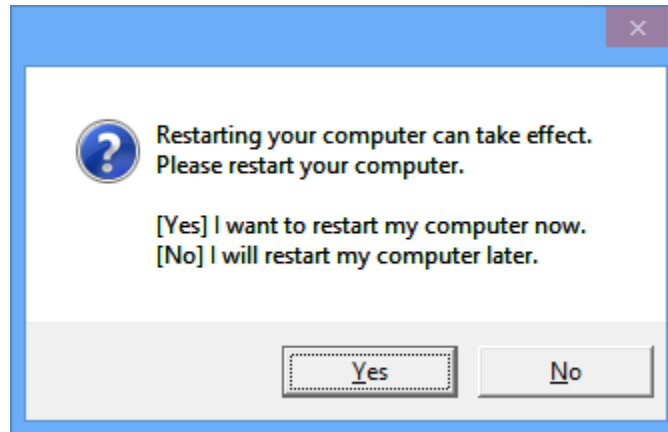

6) Open the printer properties window in the Windows OS.
 ※ Control Panel – Hardware and Sound – Device and Printers.

7) In the **Ports** tab, click **Configure Port....**

8) Match the communication settings to those of the printer.

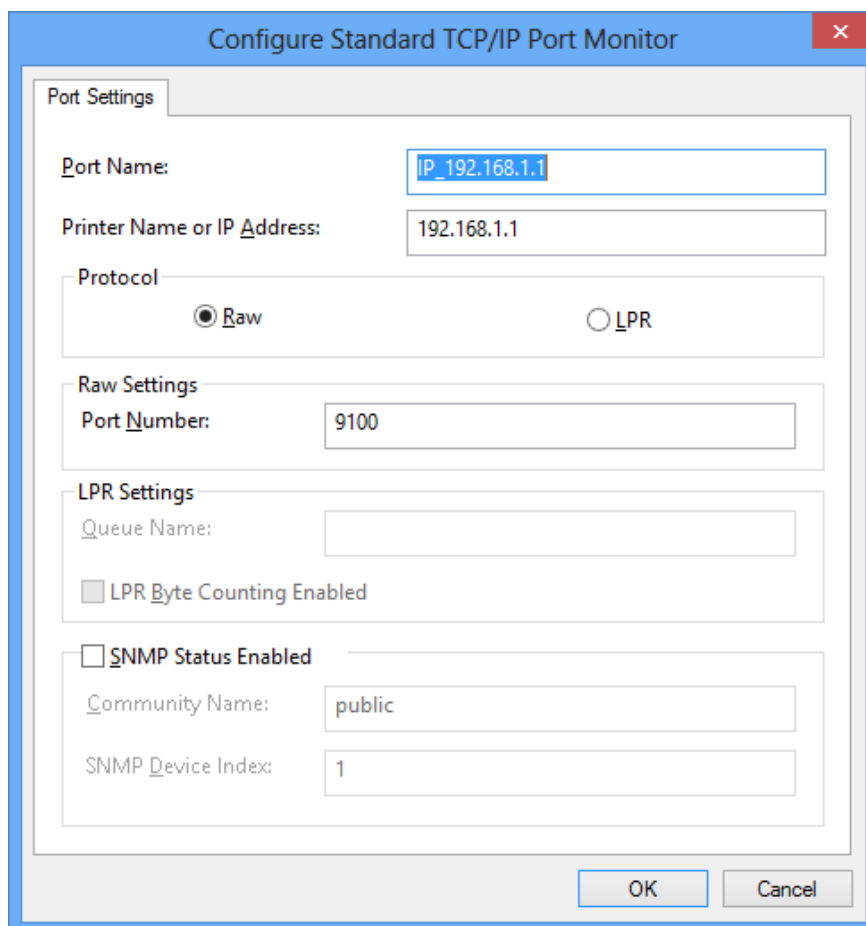

9) Click **Print Test Page** and check printing status. Proper installation of the driver is indicated if the test page is printed normally.

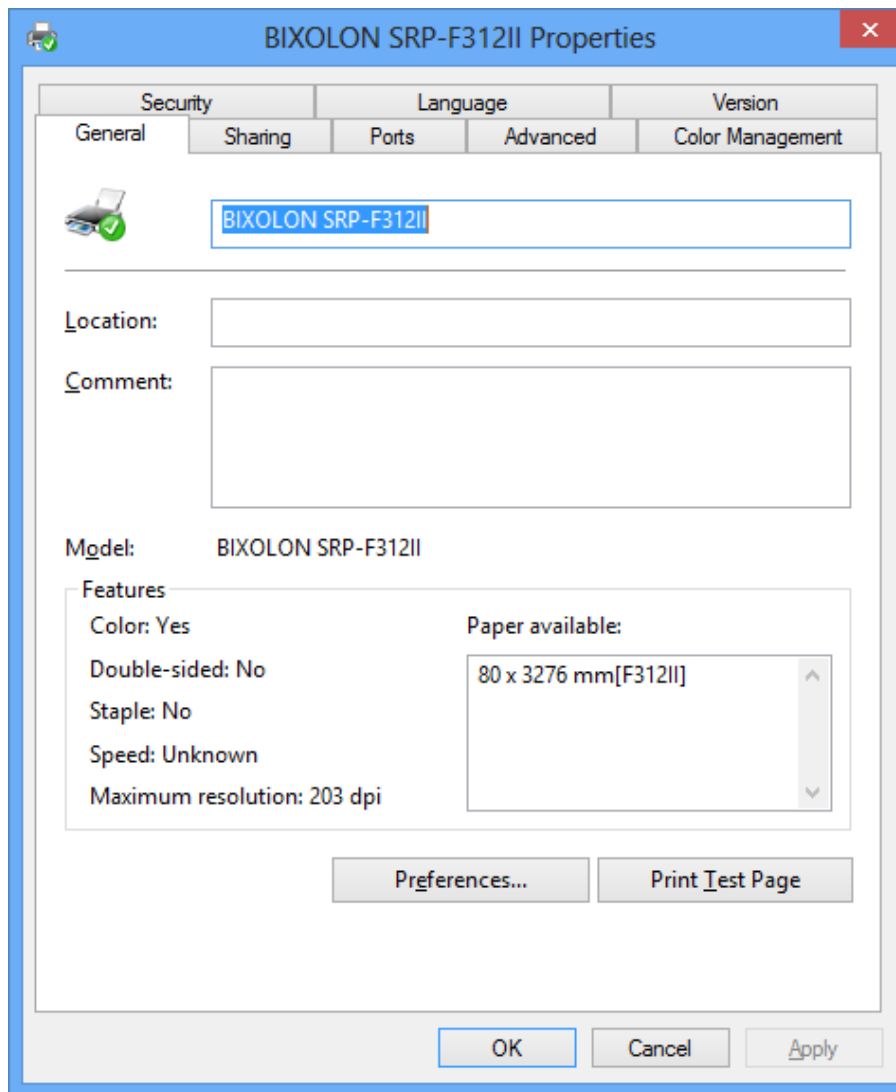

5. Windows Driver Settings

The following functions can be configured after installing the Windows driver.

5-1 Layout

The screenshot shows the 'Layout' tab of the printer driver settings. The dialog has several sections:

- Paper:** Paper Size is set to '80 x 3276 mm' and Paper Type is set to 'Receipt'.
- Number of copies:** Copies is set to '1'.
- Orientation:** 'Portrait' is selected.
- Image Rotation:** 'Normal' is selected.
- Paper Reduction:** The checkbox is unchecked, Rate is '100%', and 'Disable reducing barcode' is selected.
- Crop Function:** Both 'Top Crop Length' and 'Bottom Crop Length' are set to '0' pixels.

- 1) Open the Printer Properties window for the corresponding OS.
- 2) In the **General** tab, click **Preferences** (Printing Preferences).
- 3) Click the **Layout** tab.

5-1-1 Paper Size

Paper size of **80 x 3276 mm** is selected by default, and the following sizes can be selected.

80 × 40 mm	80 × 160 mm	80 × 3276 mm
80 × 80 mm	80 × 200 mm	
80 × 120 mm	80 × 297 mm	

If a custom paper size is required, click “...” to add or update a custom paper size. Click **Save** after specifying the paper width/length and a paper name. If the specified paper name already exists on the system, you can update the paper width/length.

Valid Paper Width : 25.4 mm ~ 72.0 mm
Valid Paper Length : 25.4 mm ~ 3276.0 mm

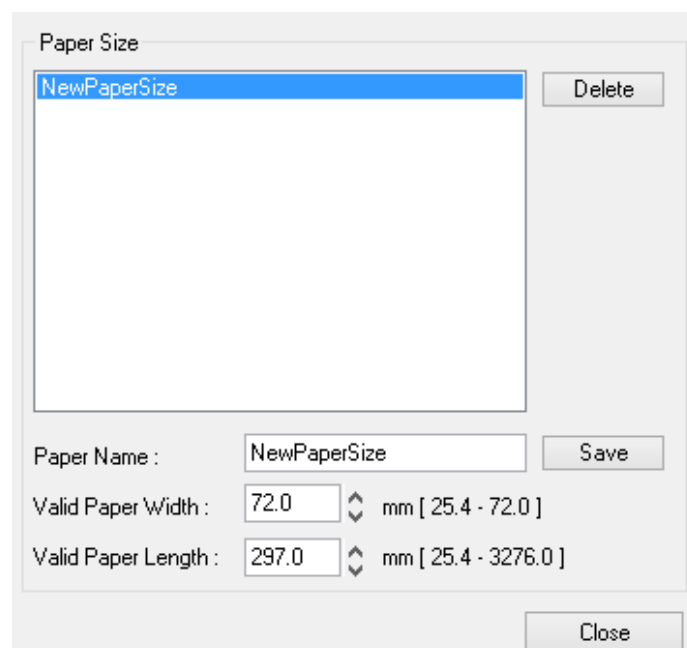

You can choose the new paper size on the **Paper Size** combo-box after adding a paper size.

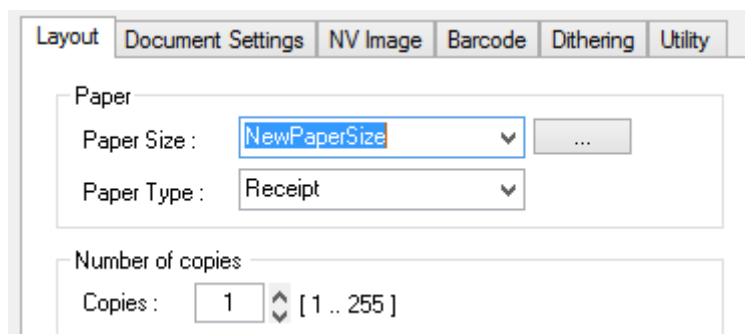

Delete button : Deletes the paper size selected in the list.

Save button : Adds a new paper size or update the paper size selected in the list if the paper name already exists on the system.

5-1-2 Paper Type

You can choose **Receipt** or **Ticket** as paper types. Receipt allows flexible paper length according to the data length. Ticket print in fixed length even the print data is short. Default setting is **Receipt**.

Receipt : Receipt allows flexible paper length according to the data length.

Ticket : Ticket print in fixed length even the print data is short.

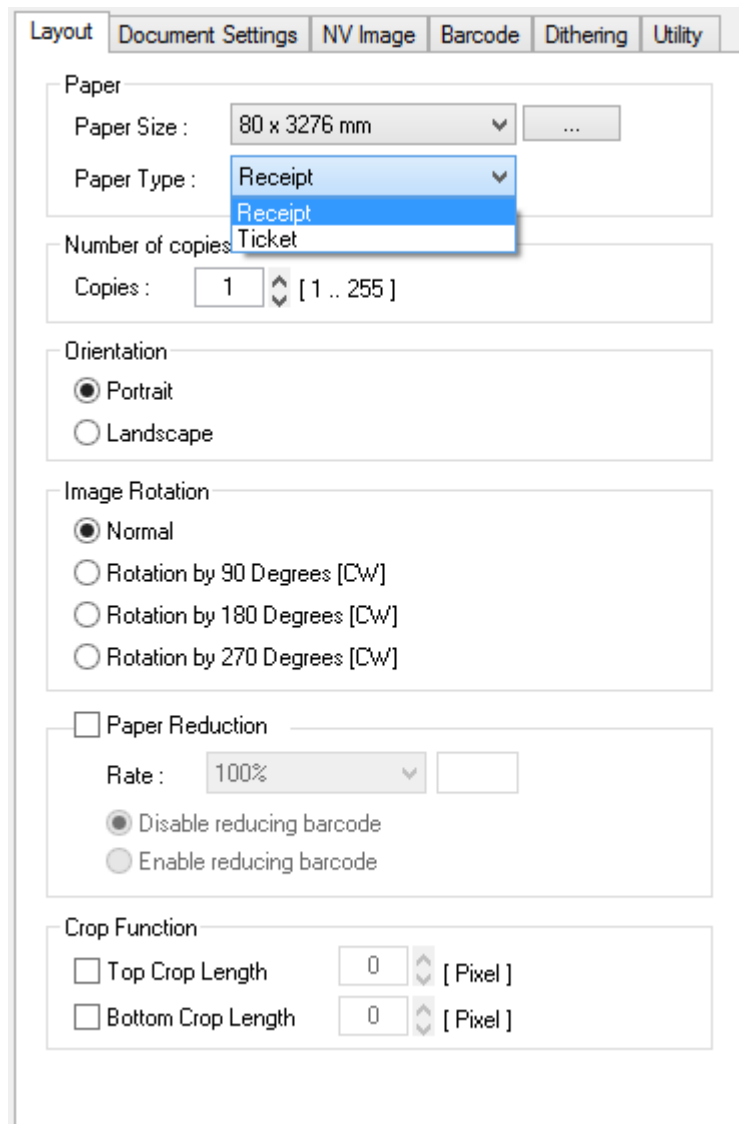

5-1-3 Copies

Copies are printed by specifying the copy count. The copy count is set to 1 by default. Set this value bigger than 1 to set the number of copies to print. The value should be within the range of 1 to 255.

5-1-4 Image Rotation

Image rotation is available for image data only. It means that rotation of device fonts or barcode fonts is not supported.

5-1-5 Paper Reduction

Reduction function reduces the size of the print image to save print paper. If this function is enabled and print-job data includes text data created by using a printer font, device fonts are converted to True Type fonts to make them smaller. The barcode size also can be reduced by selecting "**Enable reducing barcode**".

5-1-6 Crop Function

This function crops the upper and lower end of the printing area by the specified number. It helps reduce the margin at the top and bottom when there is excessive margin. The value should be within the range of 0 to 255.

5-1-7 Orientation

Printing orientation can be set to **Portrait** (which is the default) or **Landscape**. It is not possible to use device fonts and device barcodes in landscape.

Portrait : Printing in the vertical direction.

Landscape : Printing in the horizontal direction.

5-2 Document Settings

The screenshot shows the 'Document Settings' tab of a printer's configuration window. It includes the following sections:

- Send Command:** Four text input fields for 'Start Doc:', 'Start Page:', 'End Page:', and 'End Doc:'. Below them is an example: 'Example : <1B4A00>'.
- Cash Drawer / Internal Beep:** A list of six checkboxes with corresponding time values in milliseconds:
 - Open before printing #1: 50 [ms]
 - Open before printing #2: 50 [ms]
 - Open after printing #1: 50 [ms]
 - Open after printing #2: 50 [ms]
 - Beep sound before printing: 50 [ms]
 - Beep sound after printing: 50 [ms]
- Line Feed:** A label 'Line-feeds after printing:' followed by a spinner box set to '0' and a range '[0 .. 99]'.
- Paper Cut:** Three radio button options:
 - Page / Job : No Cut / No Cut
 - Page / Job : No Cut / Partial Cut
 - Page / Job : Partial Cut / Partial Cut

- 1) Open the Printer Properties window for the corresponding OS.
- 2) In the **General** tab, click **Preferences** (Printing Preferences).
- 3) Click the **Document Settings** tab.

5-2-1 Send Command

The Windows driver serves to receive the content for print from an application and send it to the printer. The “Send Commands” function allows for the addition of desired commands at the start or end of the print content.

Start Doc : Addition of command at the beginning of the document.
Start Page : Addition of command at the beginning of the page.
End Page : Addition of command at the end of the page.
End Doc : Addition of command at the end of the document.

For more information about the hexadecimals that can be entered in “Start Doc”, “Start Page”, “End Page” and “End Doc”, refer to the Commands Manual.

5-2-2 Cash Drawer / Internal Beep

To open a cash-drawer before printing, tick “Open before printing #1” or “Open before printing #2”.

To open a cash-drawer after printing, tick “Open after printing #1” or “Open after printing #2”.

To make a beep sound when printing, tick “Beep sound before printing” or “Beep sound after printing”.

5-2-3 Line Feed

It is possible to set the number of line feeds between 0 and 99 for adding blank lines at the end of printing.

5-2-4 Cut

Paper can be cut at the end of each page or each document (job).

Page/Job : No Cut / No Cut : Paper is not cut after printing.
Page/Job : No Cut / Partial Cut : Paper is cut at the end of each document (Job).
Page/Job : Partial Cut / Partial Cut : Paper is cut at the end of each page.

5-3 NV Image

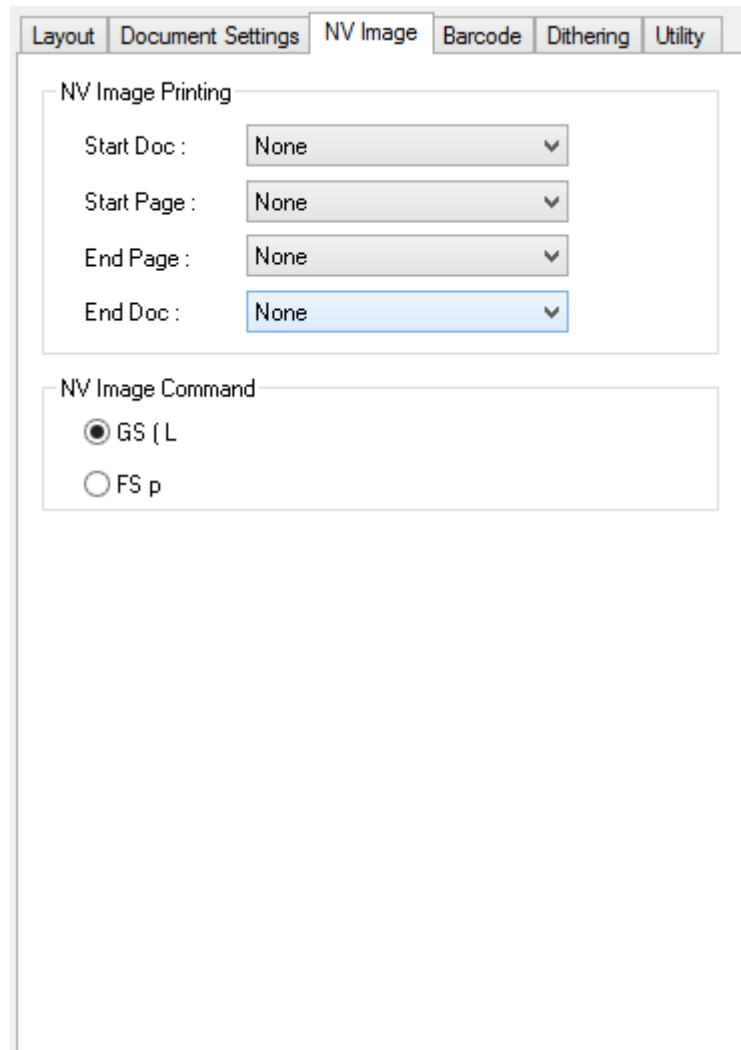

- 1) Open the Printer Properties window for the corresponding OS.
- 2) In the **General** tab, click **Preferences** (Printing Preferences).
- 3) Click the **NV Image** tab.

The position to print NV image stored in the printer can be set at the beginning and/or end of the document and beginning and end of each page. Also, there are two commands for NV Image printing. Take care of selecting one of the two commands because NV images cannot be printed depending on the selected command.

- ※ NV graphics: "FS p"
- ※ NV bit image: "GS (L"

Start Doc : Insert NV image at the top of the document.
 Start Page : Insert NV image at the top of the page.
 End Page : Insert NV image at the end of the page.
 End Doc : Insert NV image at the end of the document.

5-4 Barcode

The screenshot shows a software interface with a 'Barcode' tab selected. The interface is divided into two sections: '1D-Barcodes' and '2D-Barcodes'. In the '1D-Barcodes' section, the 'Font Name' is set to 'Barcode1' and the 'Type' is set to 'UPC-A'. Below these settings is a 'Properties' button. In the '2D-Barcodes' section, the 'Font Name' is set to '2D-Code1'. The 'Type' section has two radio buttons: 'PDF417' (which is selected) and 'QR Code'. Below these settings is another 'Properties' button. The top of the window has several tabs: 'Layout', 'Document Settings', 'NV Image', 'Barcode', 'Dithering', and 'Utility'.

- 1) Open the Printer Properties window for the corresponding OS.
- 2) In the **General** tab, click **Preferences** (Printing Preferences).
- 3) Click the **Barcode** tab.

5-4-1 1d Barcodes

Windows driver supports one-dimensional barcode fonts as shown in the following table. Barcodes can be printed by using following font names.

Font Name	Type (Symbology)	Size (Point)	Supported Characters
Barcode1	UPC-A	18 / 35.5 / 53 / 71	Numeric: 0~9
Barcode2	UPC-E	18 / 35.5 / 53 / 71	Numeric: 0~9
Barcode3	JAN13 (EAN)	18 / 35.5 / 53 / 71	Numeric: 0~9
Barcode4	JAN8 (EAN)	18 / 35.5 / 53 / 71	Numeric: 0~9
Barcode5	Code39	18 / 35.5 / 53 / 71	Numeric: 0~9 Symbols: \$, +, -, ., / Letters: A~Z
Barcode6	ITF	18 / 35.5 / 53 / 71	Numeric: 0~9
Barcode7	Codabar	18 / 35.5 / 53 / 71	Numeric : 0~9 Symbols: \$, +, -, ., /, : Letters: A~D
Barcode8	Code93	18 / 35.5 / 53 / 71	ASCII CODE: 0x00 ~ 0x7F
Barcode9	Code128	18 / 35.5 / 53 / 71	ASCII CODE: 0x00 ~ 0x7F

If you want to change the default value of 1d barcode properties, select a **Font Name** and **Type** of one-dimensional barcode, and then click **Properties**. Click **OK** after changing the values of properties.

The image shows a 'Barcode' properties dialog box. It contains the following fields and options:

- Barcode** section:
 - Width: 3 (range [2 .. 6])
 - Height: 50 (range [1 .. 255])
- HRI Position** section:
 - Dropdown menu set to 'Bottom'.
- HRI Font** section:
 - Radio button selected for 'Font A'.
 - Radio button for 'Font B'.
- Buttons: 'OK' and 'Cancel' at the bottom right.

5-4-2 2d Barcodes

Windows driver supports two-dimensional barcode fonts as shown in the following table. Barcodes can be printed on the printer by using following font names.

Font Name	Type (Symbology)	Size (Point)
2D-Code1	PDF417	8.5
2D-Code2	QR Code	8.5

If you want to change the default value of 2d barcode properties, select a **Font Name** and **Type** of two-dimensional barcode, and then click **Properties**. Click **OK** after changing the values of properties for PDF417 or QR Code.

PDF417

Column : 0 [0 .. 30]

Step : 0 [0, 3 .. 90]

Width : 3 [2 .. 8]

Height : 3 [2 .. 8]

Error Correction : Level 0

Set the processing of simplified PDF417 symbol

OK Cancel

<PDF417>

QR Code

Size : 8 [1 .. 8]

Model : Model 2

Error Correction : Level L

OK Cancel

<QR Code>

5-5 Dithering

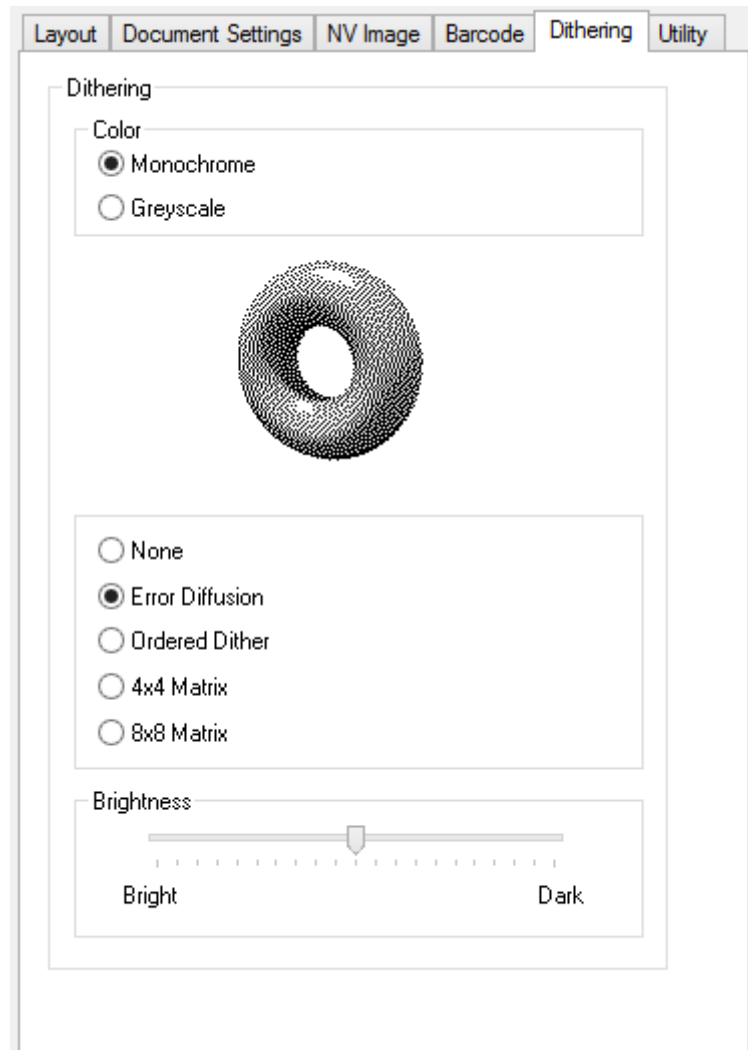

- 1) Open the Printer Properties window for the corresponding OS.
- 2) In the **General** tab, click **Preferences**.
- 3) Click the **Dithering** tab.

This printer model is a black and white printing device including dithering function, grayscale print function, and brightness level adjustment function to produce a sharper or softer image. The following dithering algorithms can be selected when **Monochrome** is selected.

- None
- Error Diffusion
- Ordered Dither
- 4x4 Matrix
- 8x8 Matrix

Print speed may become slower if **Greyscale** is selected because the large amount of data to send to the printer.

5-6 Utility

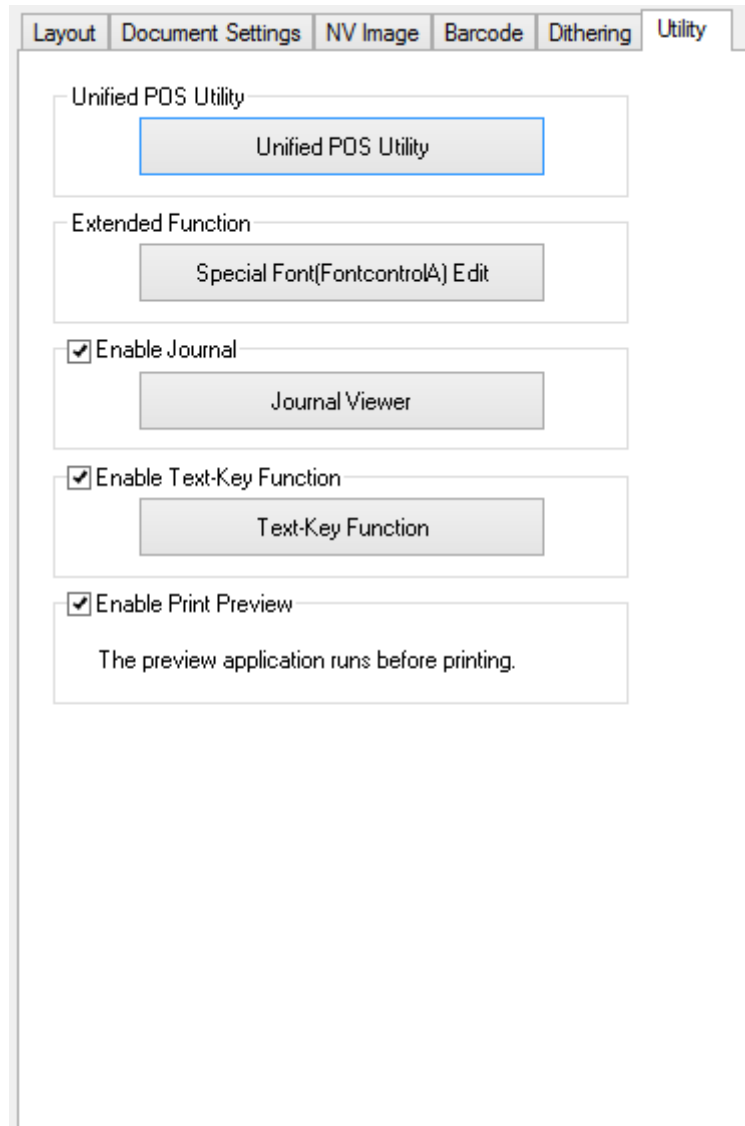

- 1) Open the Printer Properties window for the corresponding OS.
- 2) In the **General** tab, click **Preferences** (Printing Preferences).
- 3) Click the **Utility** tab.

5-6-1 Unified POS Utility

Refer to the **Unified POS Utility** manual contained in the CD for details.

5-6-2 Special Font Edit Utility

The purpose of **FontControlA** font is not for text printing. It is used to define the printer command, assign the defined printer command to a specific ASCII character, and send it to the printer. The range of ASCII code that the command can be assigned is from 0x20 to 0x7F, and the command can be easily assigned using this utility.

- 1) Click **Special Font Edit**.
- 2) Select an ASCII code character and enter the print command. All values should be entered in hexadecimal number format.
- 3) Click **Apply** and then click **OK**.

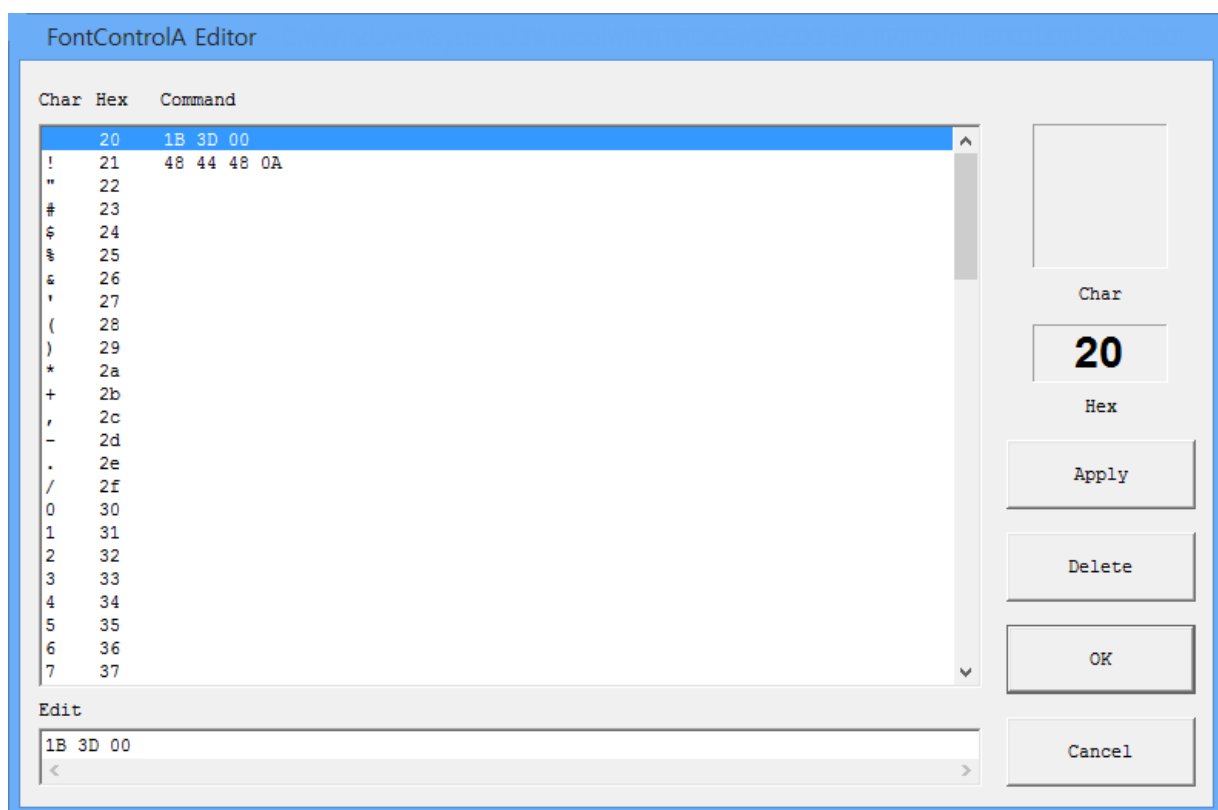

5-6-3 Journal Viewer

Journal is a function to save a copy of printed receipts. Copies can be saved without using journal printer with this function. Journal saves each printed document in a file and the saved file can be viewed by using this utility.

- 1) Tick **Enable Journal** to run **Journal Viewer**, and then click **Journal Viewer**.

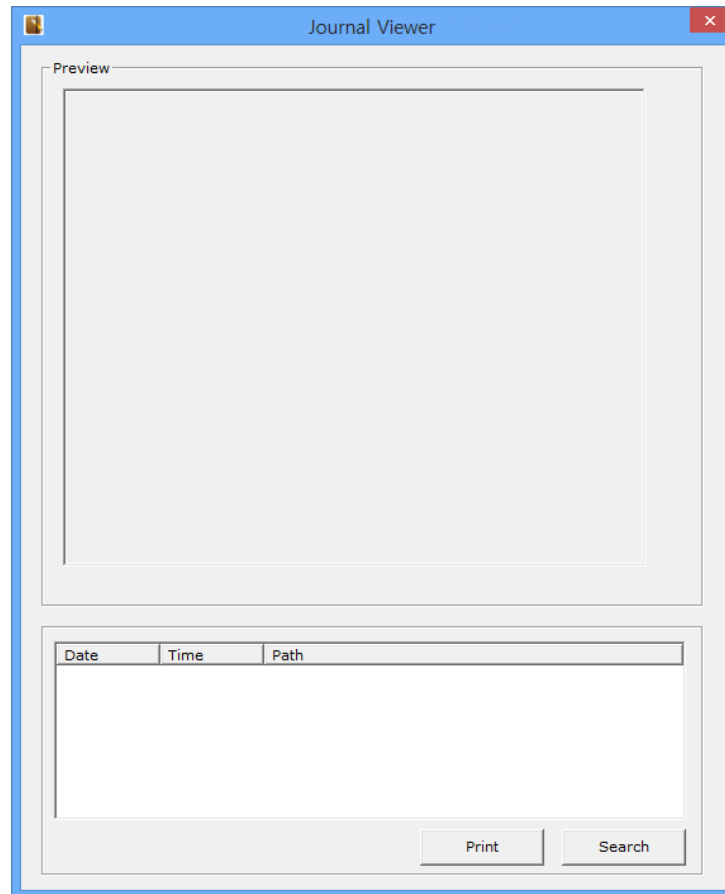

- 2) Click **Search** to set search condition, and then enter **Start Date** and **End Date**.
- 3) Click **OK** to search the files created within the specified period.

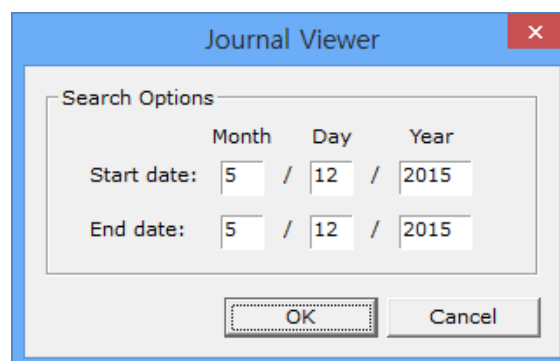

- 4) Select the file to print from the list and click **Print** to send the data stored in the file to the printer.

5-6-4 Text-Key Function

Text-Key Function is a utility to replace specific text (Text-Key) with other texts or graphic images, and to add images to the bottom of receipts. This function can be used only when using device fonts. It has no effect when using TTF fonts (True Type Fonts) or the data for Text-Key does not exist on a Print-Job.

► How to replace Text-Key with other texts.

1) Tick **Enable Text-Key Function** and then click **Text-Key Function**.

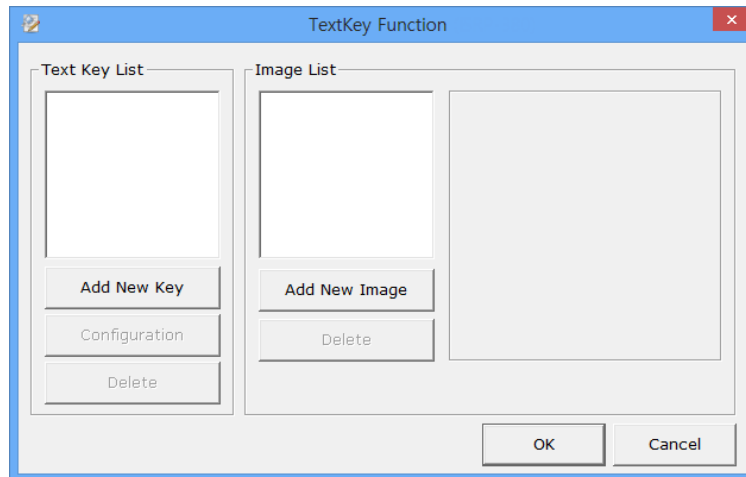

2) Click **Add New Key**, type a text to be used as Text-Key, and then click **OK**.

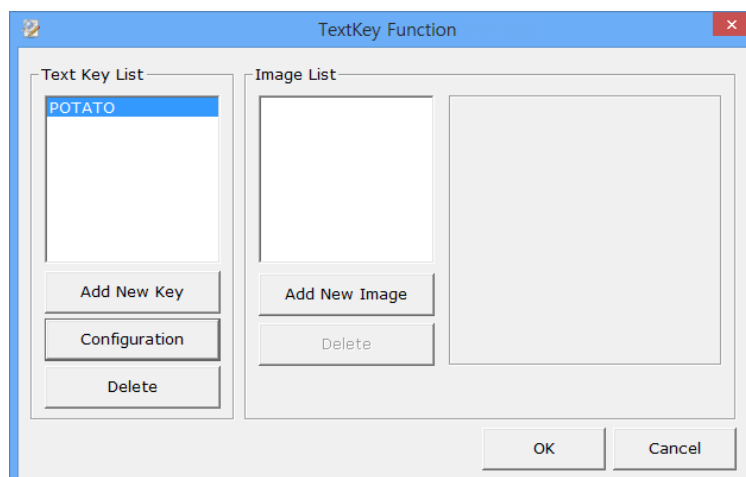
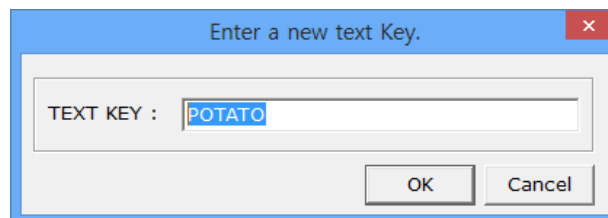

- 3) If the Text-Key is selected, The **Configuration** button is enabled.
- 4) Click **Configuration** to enter a text, which is used to replace the selected Text-Key with the text entered. For example, if you enter “**APPLE**” in the text box as below, the Text-key, “**POTATO**” can be replaced with “**APPLE**”.

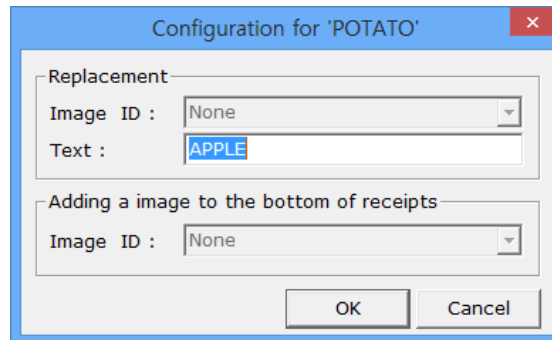

► How to replace Text-Key with a graphic image and to add it to the bottom of receipts.

- 1) This utility can also replace the selected Text-Key with a graphic image instead of texts and can add a graphic image to the bottom of receipts. It is necessary to add images to the image list.
- 2) Click **Add New Image** to browse for an image to add to the list.

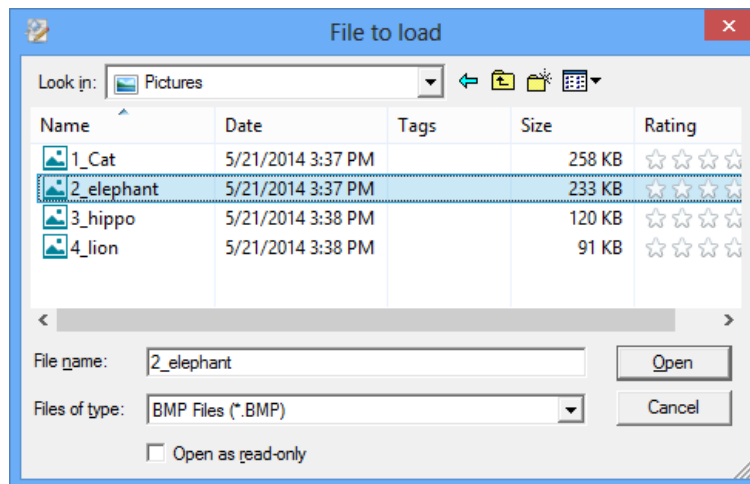

- 3) Enter a unique name to be added, adjust the brightness, select a dithering type, and then click **OK**. Repeat 2 to 3 step to add up to as much as you want.

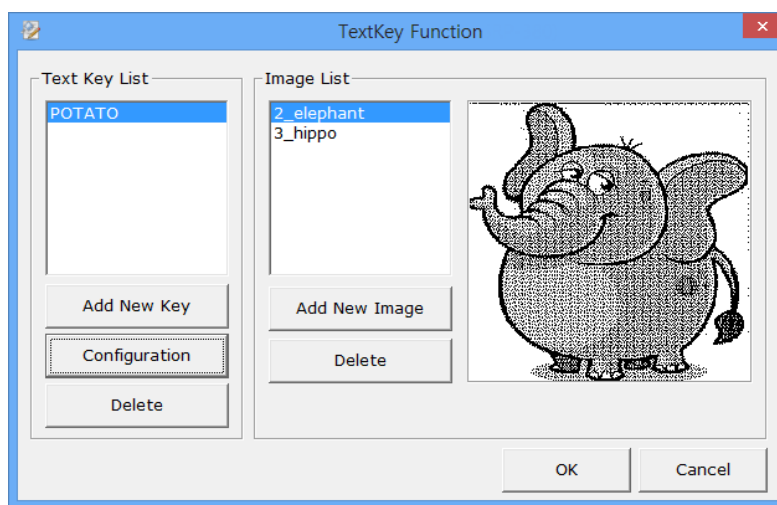
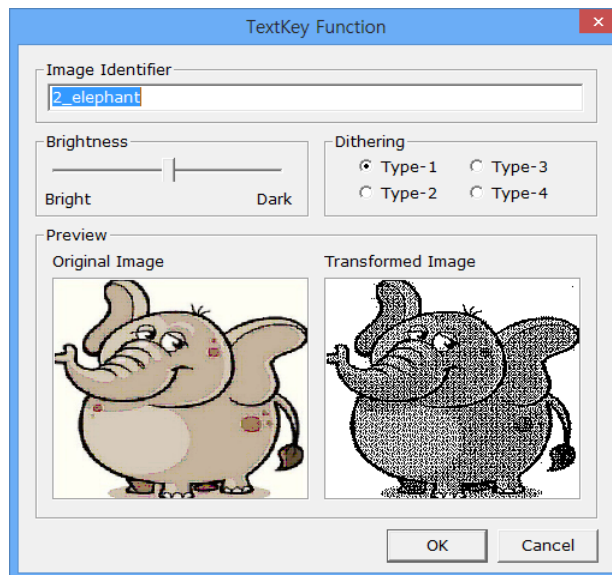

- 4) Select a Text-Key in the Text-Key list, and then click **Configuration**.
- 5) To replace the selected Text-Key with a graphic image, select one of the available identifier via the combo box under “**Replacement**” label. There are two replacement functions but only one of the two is available.

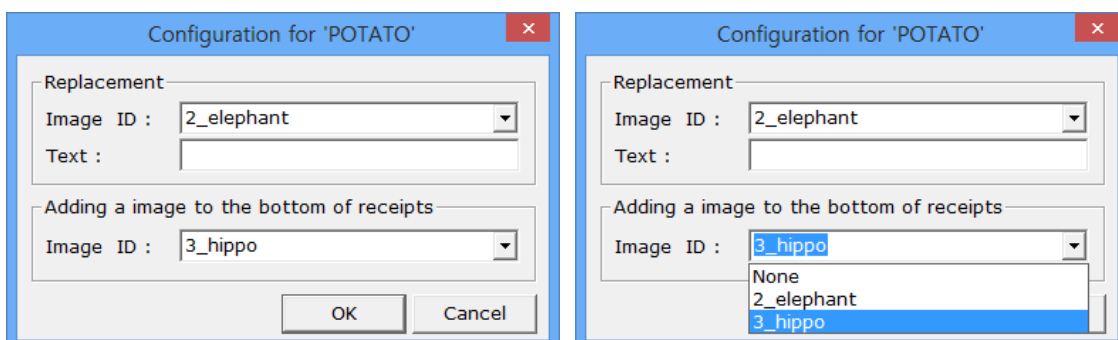

- 6) In order to print a graphic image to the bottom of receipts, select one of the available identifier via the combo box under “**Adding a image to the bottom of receipts**” label. The graphic image for the selected identifier only will be printed if the data for the selected Text-Key were found on a Print-Job.

5-6-5 Preview

This application with a preview of a print-job runs, and windows driver does not directly send print-job data to the printer when enabled by clicking “**Enable Print Preview**”. Print-job data can only be sent to the printer in the application. The actual output of preview image processed by the application might look a little different.

- 1) Tick **Enable Print Preview** to make Windows Driver ready for running the application.

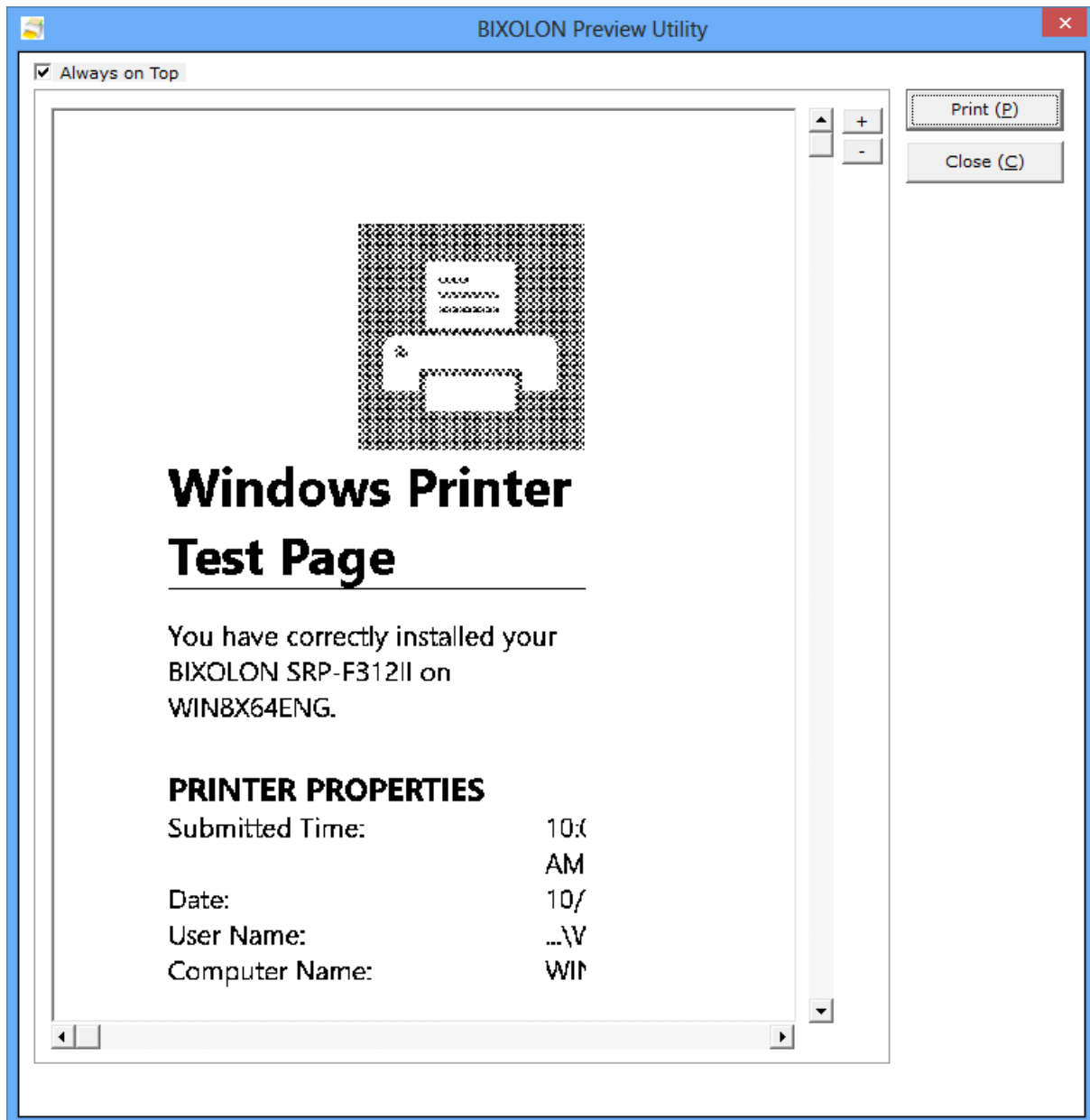

- 2) When print-job data are created via Windows Driver, the application runs, and then loads the data to draw the expected output on screen.
- 3) Click **Print** if you want to print, or click **Close** to exit the application.

5-7 Bidirectional Communication

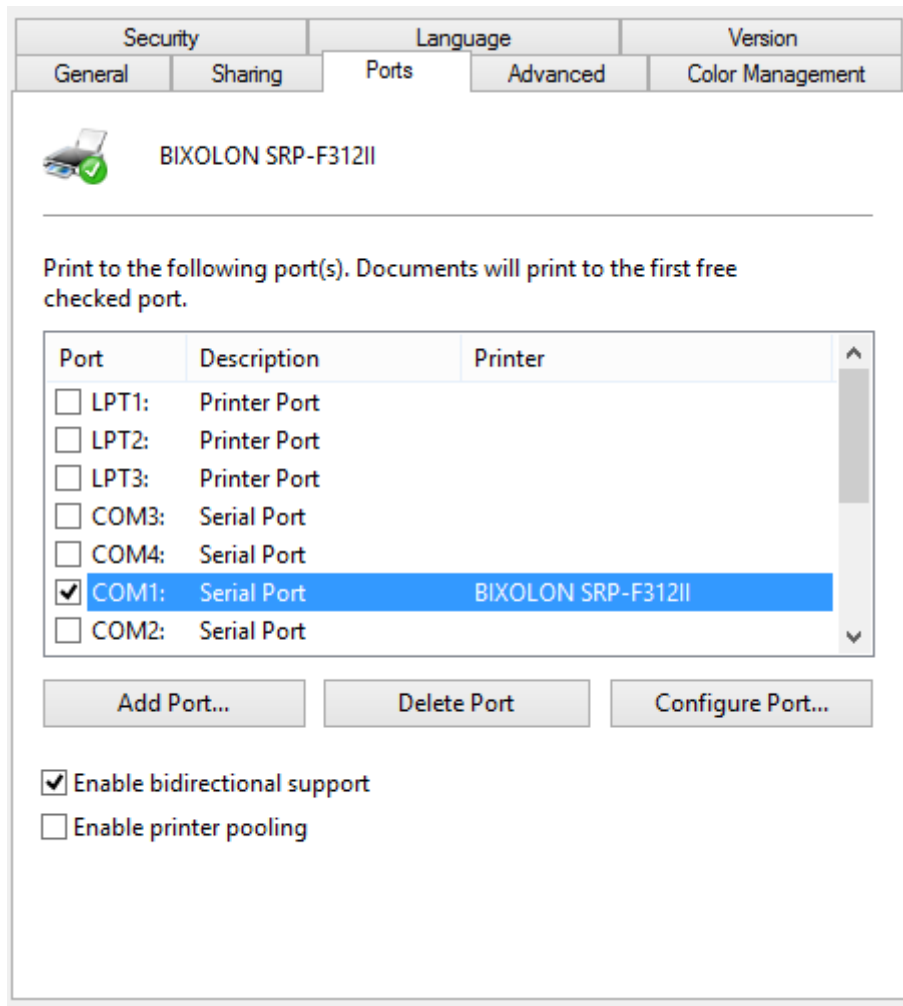

- 1) Open the Printer Properties window for the corresponding OS.
- 2) Click **Ports** tab.

It is necessary to tick **Enable bidirectional support** to get status from the printer. Sample codes contained in the CD can help you get more status information than the status information that OS supplies as standard way.

Printer status that OS support	Printer status that OS does not support
<ul style="list-style-type: none"> - ONLINE/OFFLINE - COVER OPEN/CLOSE - PAPER EMPTY 	<ul style="list-style-type: none"> - NEAR END PAPER - CASH DRAWER OPEN/CLOSE

6. Windows Driver Specifications

6-1 Font

This Windows driver supports various fonts in the following table. Printing using these fonts is faster than using Windows fonts provided by the operating system.

Printer font			Font size (dot)	Font Size (point)
FontA1x1	FontA1x1[Ext.]	FontA1x1[255]	12 x 24	8.5
FontA1x2	FontA1x2[Ext.]	FontA1x2[255]	12 x 48	17
FontA2x1	FontA2x1[Ext.]	FontA2x1[255]	24 x 24	8.5
FontA2x2	FontA2x2[Ext.]	FontA2x2[255]	24 x 48	17
FontA2x4	FontA2x4[Ext.]	FontA2x4[255]	24 x 96	34
FontA4x2	FontA4x2[Ext.]	FontA4x2[255]	48 x 48	17
FontA4x4	FontA4x4[Ext.]	FontA4x4[255]	48 x 96	34
FontA4x8	FontA4x8[Ext.]	FontA4x8[255]	48 x 192	68
FontA8x4	FontA8x4[Ext.]	FontA8x4[255]	96 x 96	34
FontA8x8	FontA8x8[Ext.]	FontA8x8[255]	96 x 192	68
FontB1x1	FontB1x1[Ext.]	FontB1x1[255]	9 x 17	6
FontB1x2	FontB1x2[Ext.]	FontB1x2[255]	9 x 34	12
FontB2x1	FontB2x1[Ext.]	FontB2x1[255]	18 x 17	6
FontB2x2	FontB2x2[Ext.]	FontB2x2[255]	18 x 34	12
FontB2x4	FontB2x4[Ext.]	FontB2x4[255]	18 x 68	24
FontB4x2	FontB4x2[Ext.]	FontB4x2[255]	36 x 34	12
FontB4x4	FontB4x4[Ext.]	FontB4x4[255]	36 x 68	24
FontB4x8	FontB4x8[Ext.]	FontB4x8[255]	36 x 136	48.5
FontB8x4	FontB8x4[Ext.]	FontB8x4[255]	72 x 68	24
FontB8x8	FontB8x8[Ext.]	FontB8x8[255]	72 x 136	48.5
FontC1x1	FontC1x1 [Ext.]	FontC1x1 [255]	9 x 24	8.5
FontC1x2	FontC1x2 [Ext.]	FontC1x2 [255]	9 x 48	17
FontC2x1	FontC2x1 [Ext.]	FontC2x1 [255]	18 x 24	8.5
FontC2x2	FontC2x2 [Ext.]	FontC2x2 [255]	18 x 48	17
FontC2x4	FontC2x4 [Ext.]	FontC2x4 [255]	18 x 96	34
FontC4x2	FontC4x2 [Ext.]	FontC4x2 [255]	36 x 48	17
FontC4x4	FontC4x4 [Ext.]	FontC4x4 [255]	36 x 96	34
FontC4x8	FontC4x8 [Ext.]	FontC4x8 [255]	36 x 192	68
FontC8x4	FontC8x4 [Ext.]	FontC8x4 [255]	72 x 96	34
FontC8x8	FontC8x8 [Ext.]	FontC8x8 [255]	72 x 192	68

Printer Fonts are defined as follows.

1) FontA1x2

- ANSI Character code support (Code page 1252)
- Font size (dot): 12 x 48 (Double height)
- Size (point): 17

2) FontA1x2[Ext.]

- IBM expansion Character code support (Code page 437)
- Font size (dot): 12 x 48 (Double height)
- Size (point): 17

3) FontA1x2[255]

- Buyer exclusive code support (User Code page)
- Font size (dot): 12 x 48 (Double height)
- Size (point): 17

6-2 Special functions

This Windows driver supports the special functions as shown in the following table. Select **FontControl** font first and use the characters in the table to use the special functions. Take care as this function is not for printing general texts.

Character	Special Function
5	Prints HT (0 x 09)
6	Prints LF (0 x 0A)
7	Prints CR (0 x 0D)
a	Open Drawer 2 (50ms drive pulse width)
b	Open Drawer 2 (100ms drive pulse width)
c	Open Drawer 2 (150ms drive pulse width)
d	Open Drawer 2 (200ms drive pulse width)
e	Open Drawer 2 (250ms drive pulse width)
f	Open Drawer 2 without paper feeding (50ms driver pulse width)
g	Cut Receipt (partial cut) without paper feeding
i	Prints the NV Image saved in the 00 address (double-size)
j	Prints the NV Image saved in the 01 address (double-size)
k	Prints the NV Image saved in the 02 address (double-size)
l	Prints the NV Image saved in the 03 address (double-size)
m	Prints the NV Image saved in the 04 address (double-size)
p	Does not add HRI characters to the barcode
q	Adds HRI characters in Font A above the barcode
r	Adds HRI characters in Font A below the barcode
s	Adds HRI characters in Font B above the barcode
t	Adds HRI characters in Font B below the barcode
u	Turns white/black reverse printing mode on
v	Turns white/black reverse printing mode off
w	Aligns text to the left
x	Aligns text to the center
y	Aligns text to the right
A	Open Drawer 1 (50ms drive pulse width)
B	Open Drawer 1 (100ms drive pulse width)
C	Open Drawer 1 (150ms drive pulse width)
D	Open Drawer 1 (200ms drive pulse width)
E	Open Drawer 1 (250ms drive pulse width)
F	Open Drawer 1 without paper feeding (50ms driver pulse width)
G	Prints the NV bitmap saved in the 00 address
H	Prints the NV bitmap saved in the 01 address
I	Prints the NV bitmap saved in the 02 address
J	Prints the NV bitmap saved in the 03 address
K	Prints the NV bitmap saved in the 04 address
P	Cut Receipt (partial cut)
R	Prints the NV Image saved in the 00 address
S	Prints the NV Image saved in the 01 address
T	Prints the NV Image saved in the 02 address
U	Prints the NV Image saved in the 03 address
V	Prints the NV Image saved in the 04 address
[Prints the NV bitmap saved in the 00 address (double-size)
]	Prints the NV bitmap saved in the 01 address (double-size)
^	Prints the NV bitmap saved in the 02 address (double-size)
_	Prints the NV bitmap saved in the 03 address (double-size)
`	Prints the NV bitmap saved in the 04 address (double-size)

1) Example

Select **FontControl** font and send 6 for “LF” (Line Feed) operation (instead of printing character “6”).

2) **FontControl** font functions.

Font Name	Special Functions	Font Size (point/dot)
FontControl	Open Drawer 1/2 Cut receipt Cut receipt(without paper feeding) Justification (Left/Center/Right) Output HT, Output LF, Output CR Barcode Printing Print NV Graphic Data	(8.5 / 12x24)

7. Use of Windows Driver

7-1 Use of Visual Basic

This section contains example codes to control the printer using Windows driver with Visual Basic. Sample programs are included in the CD.

7-1-1 Windows Driver Selection

The following example code explains how to select "BIXOLON SRP-F312II" Windows driver.

```
For Each prnPrinter In Printers
    If prnPrinter.DeviceName = "BIXOLON SRP-F312II" Then
        Set Printer = prnPrinter
    Exit For
End If
Next
```

7-1-2 Text Printing

The following example code explains how to print texts using Windows Fonts and Device Fonts.

```
'Print in Windows font
Printer.FontSize = 9
Printer.FontName = "Arial"
Printer.Print "Arial Test"

'Print in printer font
Printer.FontSize = 8.5
Printer.FontName = "FontA1x1"
Printer.Print "FontA1x1 Font"

Printer.EndDoc
```

7-1-3 Barcode Printing

The following example code explains how to print the barcode (JAN8 (EAN)).

```
'Print Bar Code.  
Printer.FontSize = 18  
  
Printer.FontName = "Barcode4"  
Printer.Print "1234567"  
  
Printer.EndDoc
```

The following example code explains how to print the 2D barcode (PDF417).

```
'Print Two-dimensional Codes.  
Printer.FontSize = 8.5  
  
Printer.FontName = "2D-Code1"  
Printer.Print "Print Test PDF417"  
  
Printer.EndDoc
```

7-2 Use of WordPad

7-2-1 WordPad Environment Settings

Launch WordPad, set the printing related options as follows, and test the printer with WordPad.

- Select printer
Select "Print" from the "File" menu, and select the printer (BIXOLON SRP-F312II).
- Set paper size, orientation, margin, etc.
Select the "Page Setting" from "File" menu, and set paper size, orientation, and margin.

7-2-2 Text Printing

Print the text from WordPad using the Windows driver of the printer.

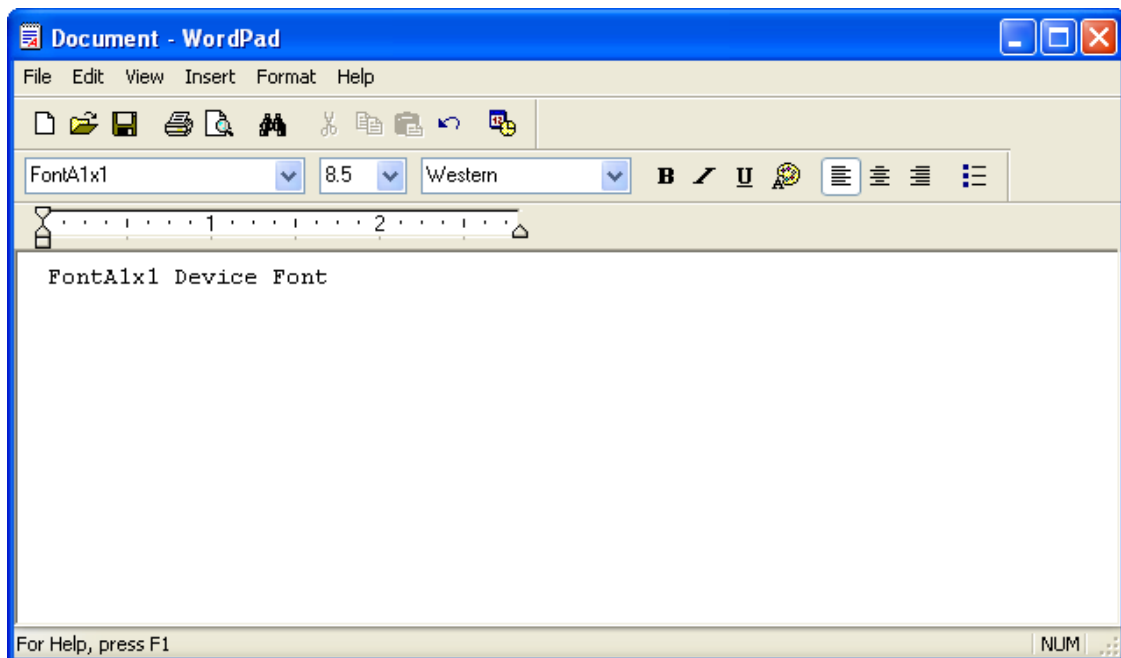

- 1) Select the font from the font selection box (FontA1x1).
- 2) Select the point size from the point selection box (8.5).
- 3) Enter the text to print.
- 4) Click the Print icon in the toolbar to print the text.