



> PRINT > COPY > SCAN

ECOSYS M3145dn

> PRINT > COPY > SCAN > FAX

ECOSYS M3645dn

# FIRST STEPS QUICK GUIDE



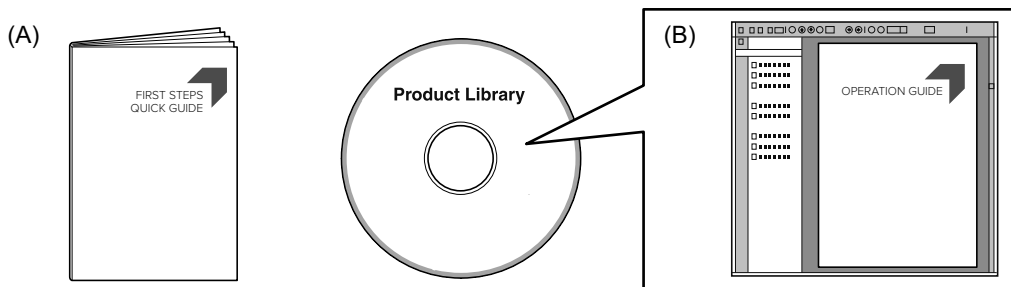

- EN** This guide (A) only explains the basic operations of the machine.  
For other information, see Operation Guide (B) on the Product Library disc.
- CA** En aquesta guia (A) només es descriuen les operacions bàsiques de la màquina. Per obtenir més informació, consulteu la Guia de Funcionament (B) al disc Biblioteca del producte (Product Library).
- CS** Tento průvodce (A) vysvětluje pouze základní obsluhu zařízení.  
Bližší informace naleznete v Návodu k obsluze (B) na disku Product Library.
- DA** Denne vejledning (A) forklarer kun de grundlæggende funktioner af maskinen.  
Andre oplysninger findes i Betjeningsvejledning (B) på Product Library disken.
- DE** Dieser Leitfaden (A) erläutert nur die grundlegende Bedienung des Geräts.  
Für weitere Informationen, siehe Bedienungsanleitung (B) in der Product Library auf dem Datenträger.
- EL** Οι παρούσες οδηγίες (A) επεξηγούν μόνο τις βασικές λειτουργίες του μηχανήματος.  
Για άλλες πληροφορίες, ανατρέξτε στις Οδηγίες χρήσης (B) στο δίσκο Product Library.
- ES** En esta guía (A) solo se explican los procedimientos básicos de la máquina.  
Para obtener otra información, consulte la Guía de uso (B) en el disco Product Library.
- FI** Tässä oppaassa (A) kuvataan vain laitteen perustoiminnot.  
Katso tarkemmat tiedot Product Library -levyn Käyttöopas (B).
- FR** Ce guide (A) explique uniquement les opérations de base de la machine.  
Pour toute autre information, se reporter au Manuel d'utilisation (B) sur le disque Product Library.
- HU** Ez az útmutató (A) csak a készülék alapvető működését ismerteti.  
Bővebb információért lásd a Használati útmutatót (B) a Product Library lemezen.
- IT** Questa guida (A) descrive solo le funzioni base del dispositivo.  
Per ulteriori informazioni, vedere la Guida alle funzioni (B) sul disco Product Library.
- NL** In deze handleiding (A) worden alleen de basisfuncties van de machine beschreven.  
Voor meer informatie, raadpleeg de gebruikershandleiding (B) op de Product Library schijf.
- NO** Denne guide (A) forklarer bare den grunnleggende bruken av maskinen.  
For annen informasjon, se Operatørhåndbok (B) i Product Library platen.

**PL** Niniejszy podręcznik (A) objaśnia jedynie podstawowe sposoby używania urządzenia.  
Więcej informacji można znaleźć w Podręczniku Obsługi (B) lub na dysku Product Library.

**PT-BR** Este guia (A) somente explica as operações básicas da máquina.  
Para obter outras informações, consulte o Guia de Operação (B) no disco Product Library.

**PT-PT** Este guia (A) explica apenas as operações básicas da máquina.  
Para obter mais informações, consulte o Guia de Operação (B) no disco Product Library.

**RO** Acest ghid (A) explică doar operațiunile de bază ale aparatului.  
Pentru alte informații, consultați Ghidul de Operare (B) de pe discul Product Library.

**RU** В данном руководстве (A) описаны только основные операции с устройством.  
Дополнительные сведения см. в руководстве по эксплуатации (B) на диске Product Library.

**SV** I den här guiden (A) förklaras endast maskinens grundfunktioner.  
För annan information hänvisas till bruksanvisningen (B) på skivan Product Library.

**TR** Bu kılavuz (A) sadece makinenin temel işlemlerini açıklar.  
Diğer bilgiler için, Product Library diskindeki Çalıştırma Kılavuzuna (B) bakınız.

**AR** هذا الدليل (A) يشرح فقط عمليات تشغيل الجهاز الأساسية.  
لمزيد من المعلومات، راجع دليل التشغيل (B) الموجود على قرص Product Library.

## Unpacking

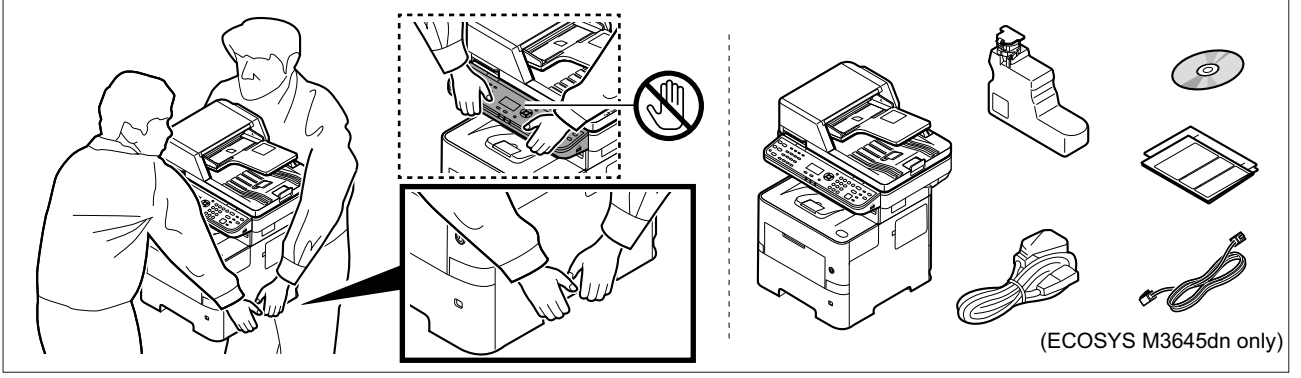

- EN** The included components differ depending on the countries or regions.
- CA** Els components que s'hi inclouen poden variar en funció dels països o de les regions.
- CS** Přiložené součásti se mohou lišit v závislosti na zemích nebo oblastech.
- DA** De medfølgende komponenter varierer afhængigt af land eller region.
- DE** Je nach Land oder Region sind im Lieferumfang andere Komponenten enthalten.
- EL** Τα εξαρτήματα που περιλαμβάνονται ενδέχεται να διαφέρουν ανάλογα με τη χώρα ή την περιοχή.
- ES** Los componentes facilitados varían en función de los países o regiones.
- FI** Pakkaukseen kuuluvat osat vaihtelevat maan ja alueen mukaan.
- FR** Les composants inclus varient en fonction des pays ou régions.
- HU** A mellékelt alkatrészek országtól vagy régiótól függően változók.
- IT** I componenti inclusi sono differenti a seconda del paese o della zona geografica.
- NL** De meegeleverde onderdelen verschillen volgens het land of de regio.
- NO** De medfølgende komponentene varierer avhengig av land eller region.
- PL** Dołączone do urządzenia wyposażenie może różnić się w zależności od kraju lub regionu.
- PT-BR** Os componentes incluídos variam conforme os países ou as regiões.
- PT-PT** Os componentes incluídos variam consoante os países ou regiões.
- RO** Componentele incluse diferă în funcție de țară sau regiune.
- RU** Комплектация компонентами зависит от страны или региона.
- SV** De medföljande komponenterna varierar i olika länder och regioner.
- TR** Ürünle birlikte verilen parçalar ülkeye veya bölgeye göre değişir.
- AR** تختلف المكونات المضمنة باختلاف البلاد أو المناطق.

# A Setting up the Toner Container

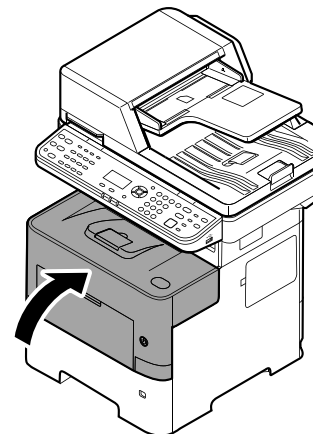
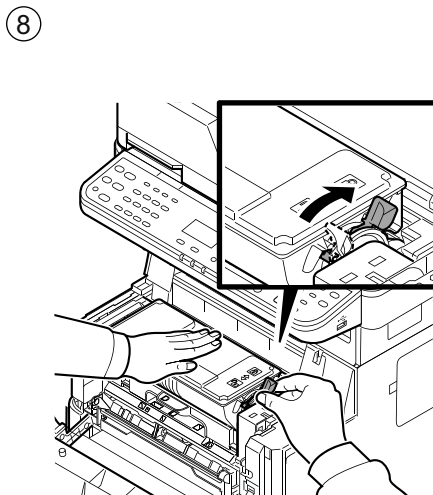
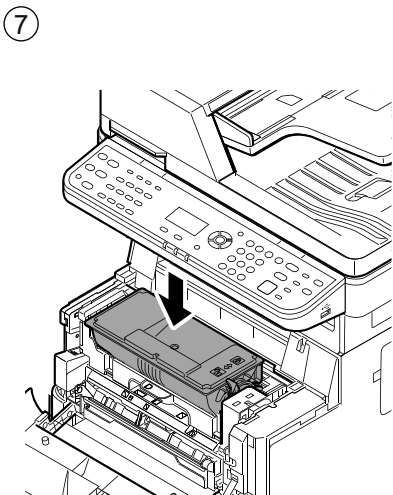
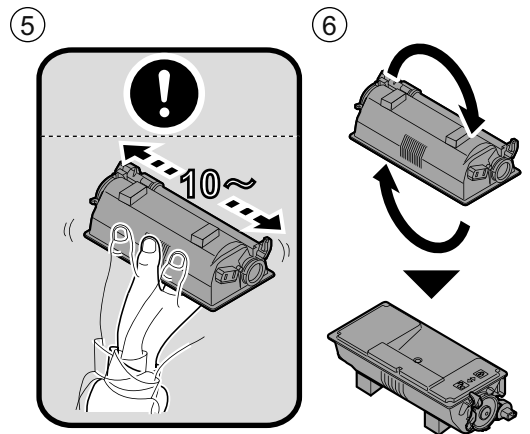
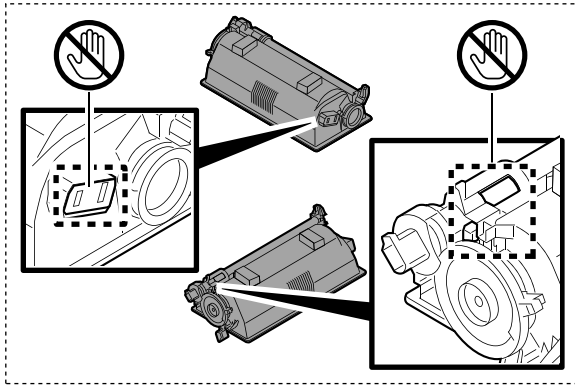
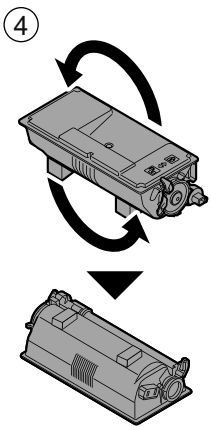
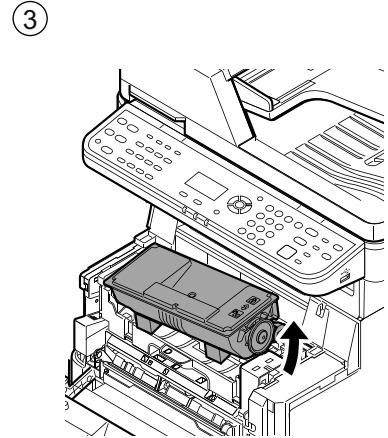
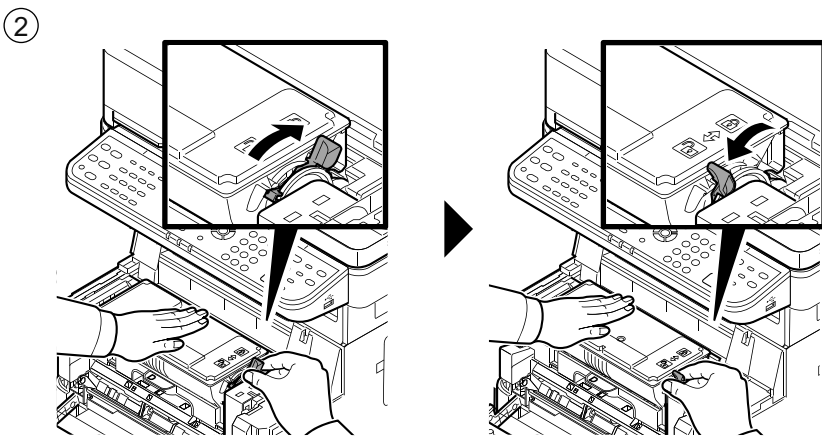
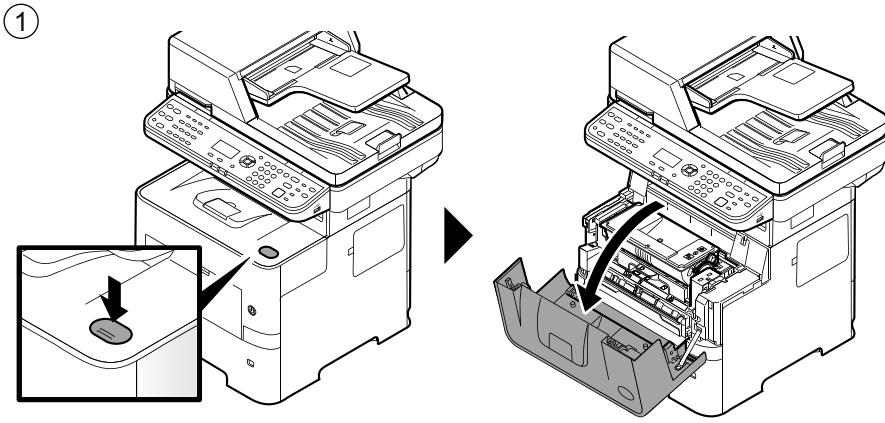

## B Install Waste toner box

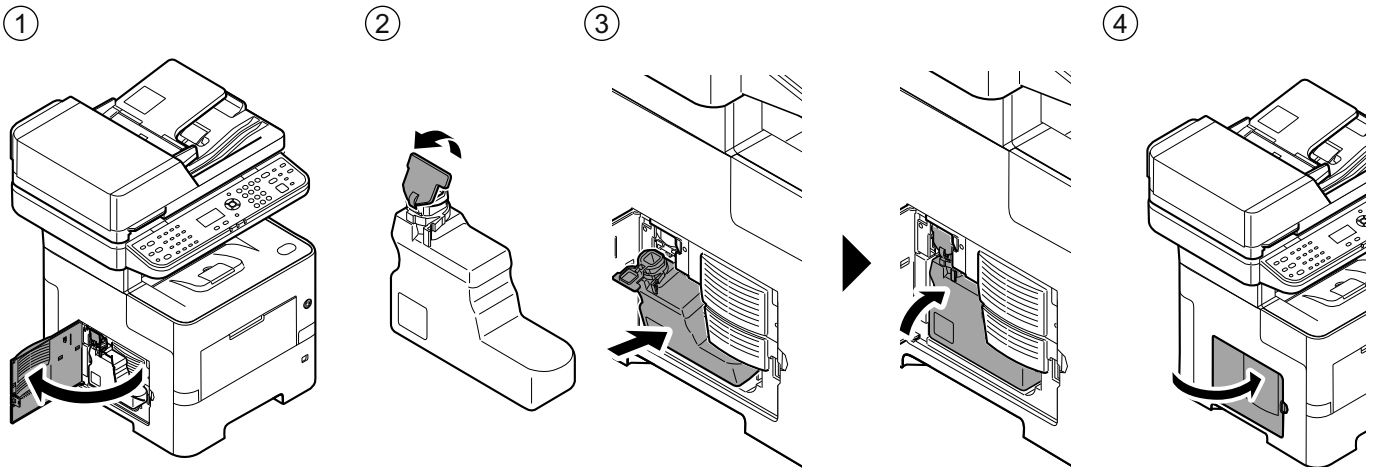

## C Connect Cable

### Network

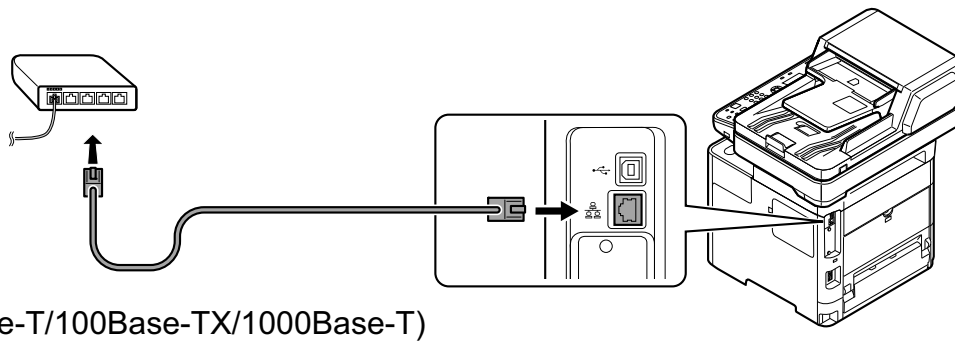

---

### USB

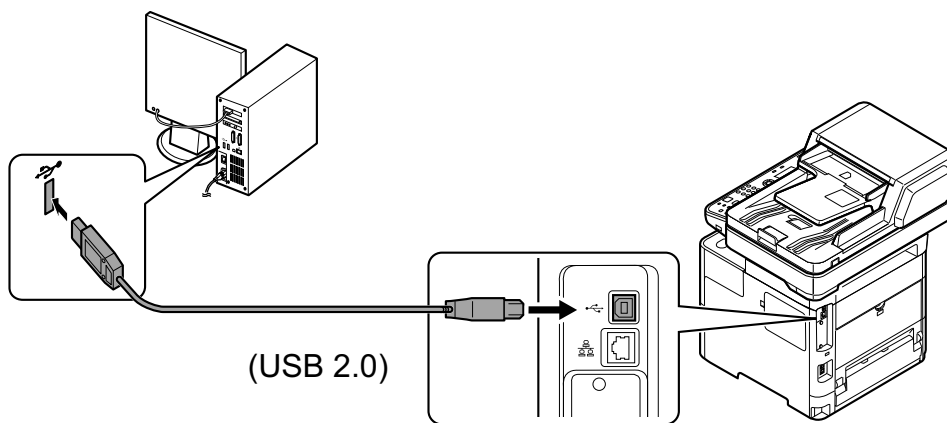

# D Loading Paper

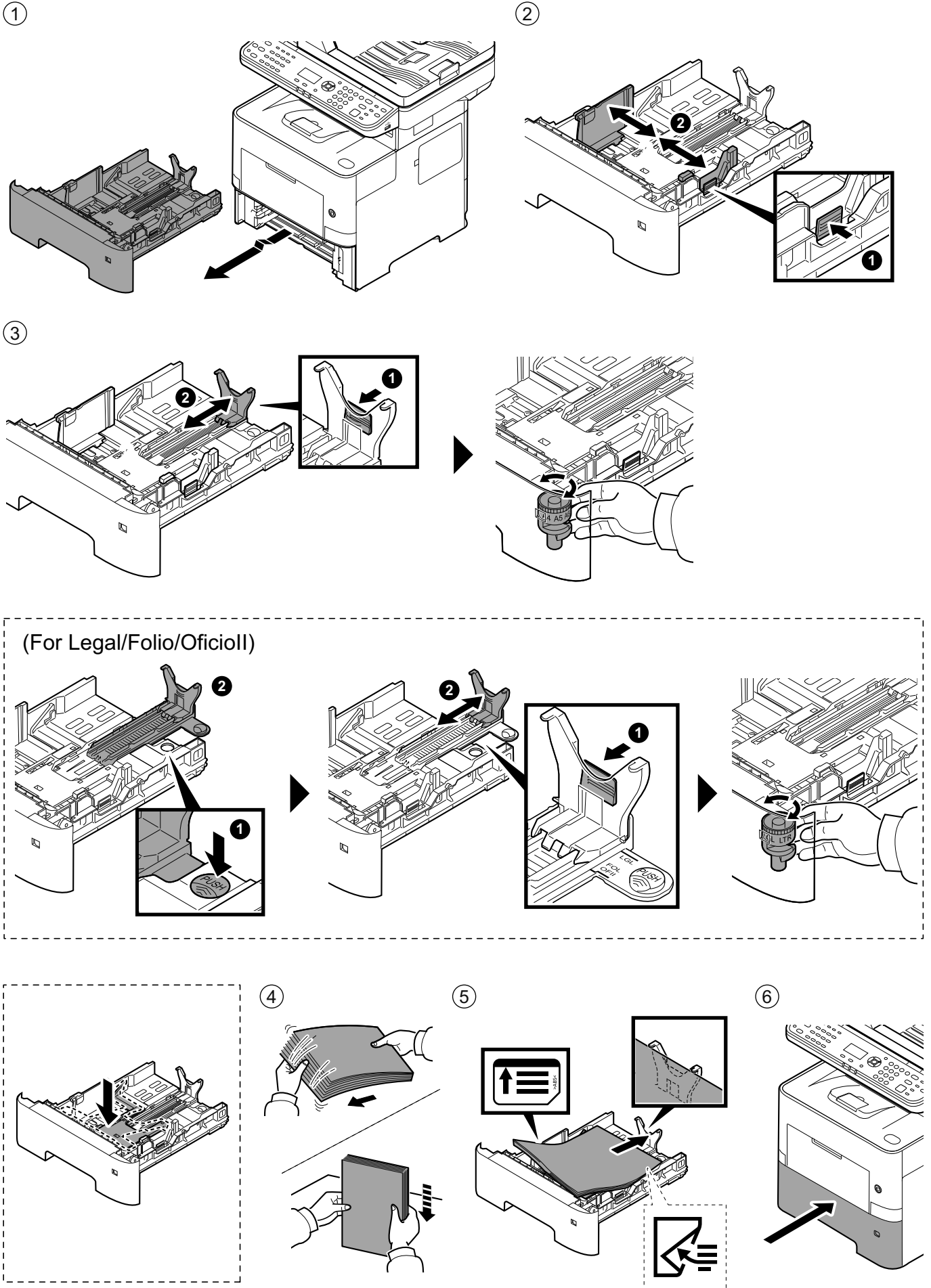

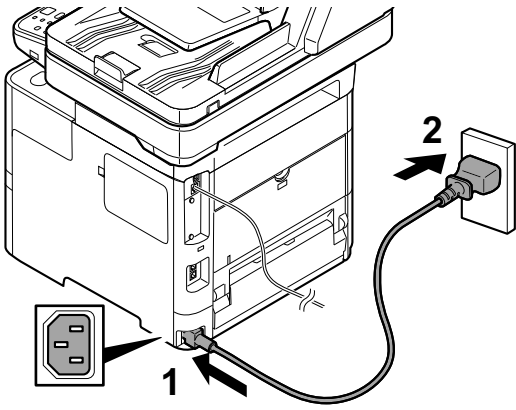
**E****Connect Power Cord****F****Replace Operation Panel Sheet**

①

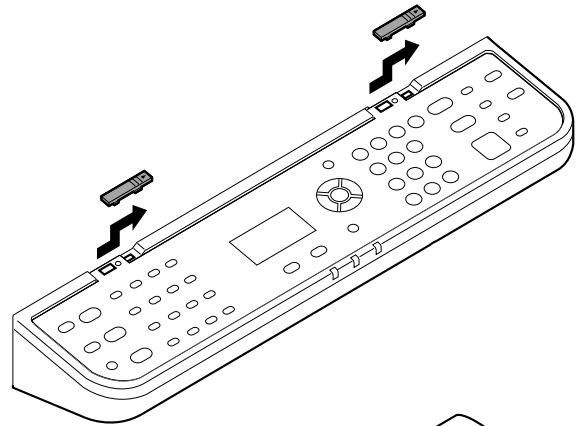
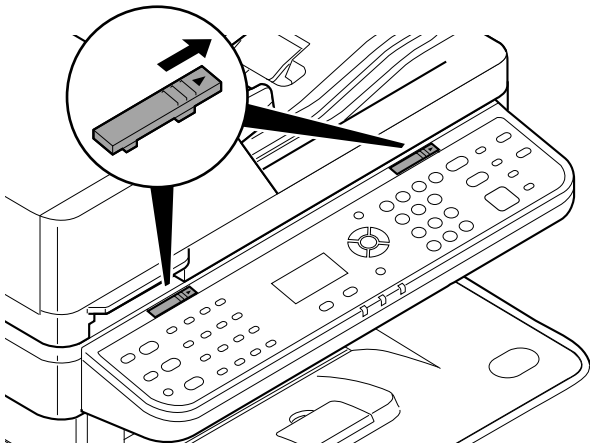

②

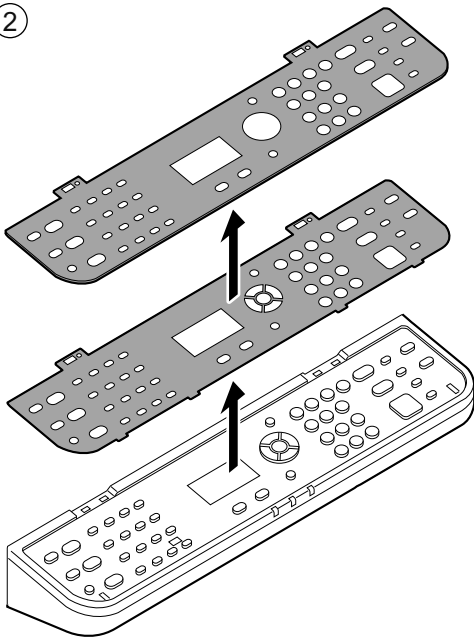

③

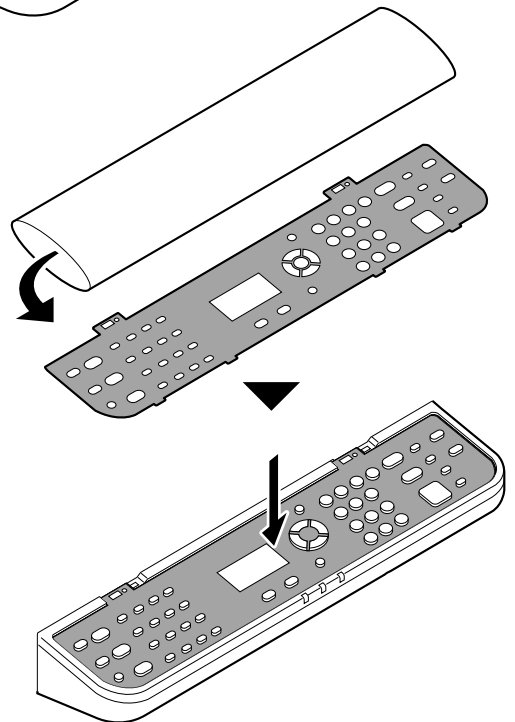



④

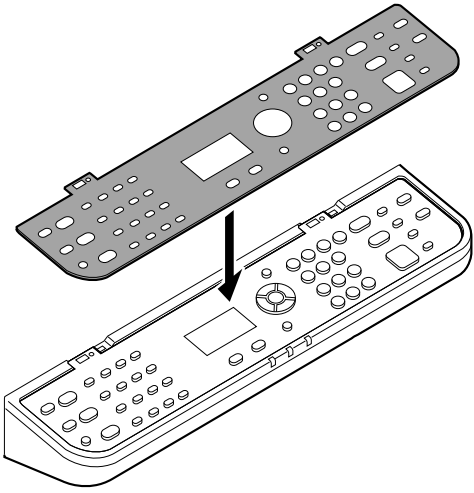

⑤

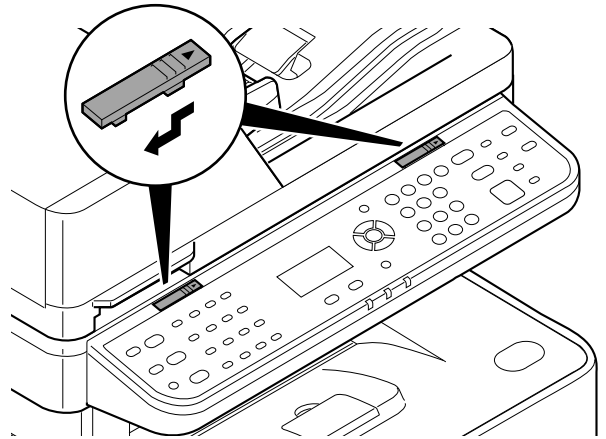

**G**

**Power On**

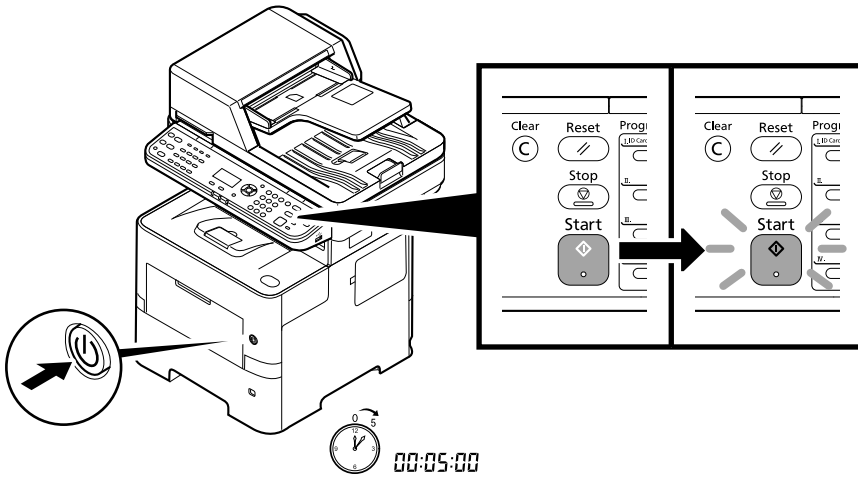

①

ECOSYS M3645dn

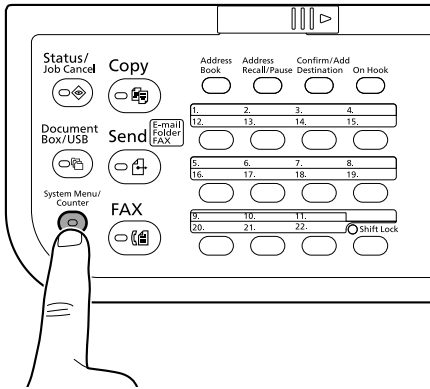

ECOSYS M3145dn

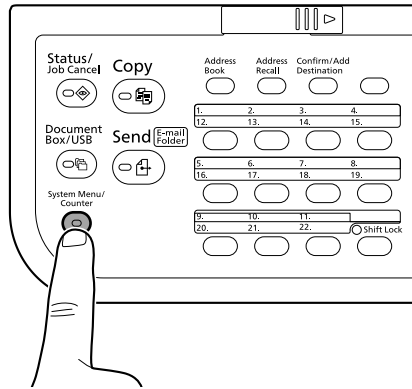

②

EN

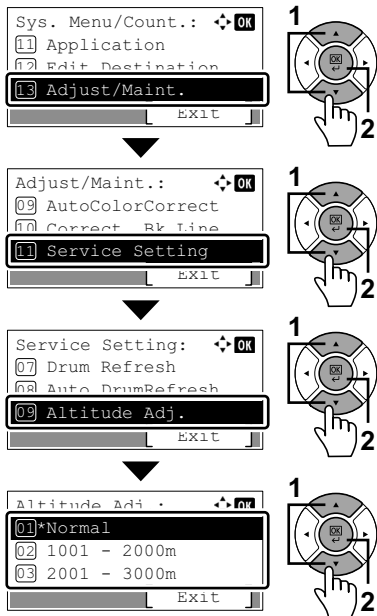

ES

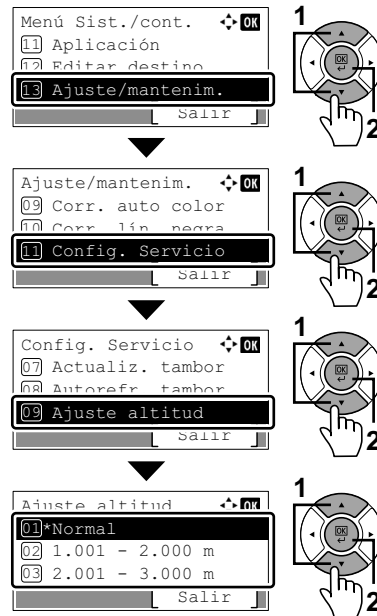

FR

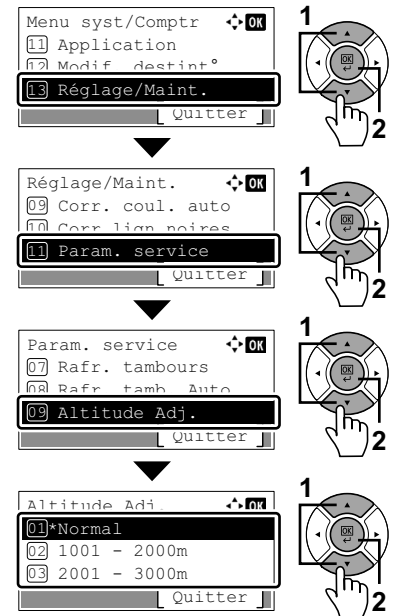

PT-BR

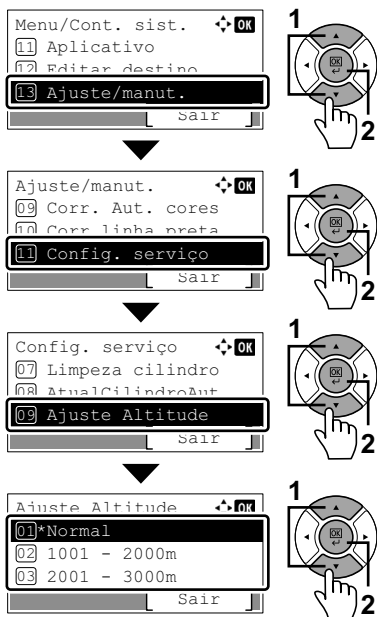

# Print Status Page

①

ECOSYS M3645dn

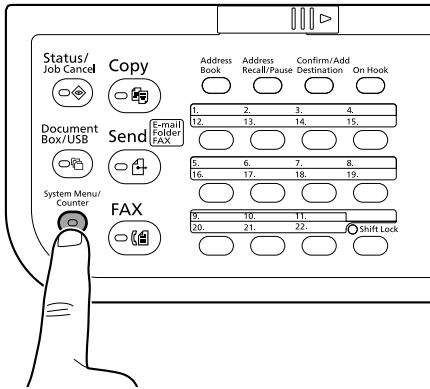

ECOSYS M3145dn

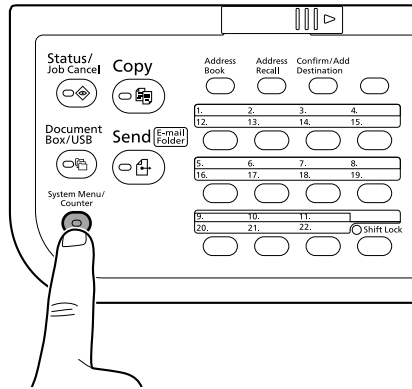

②

EN

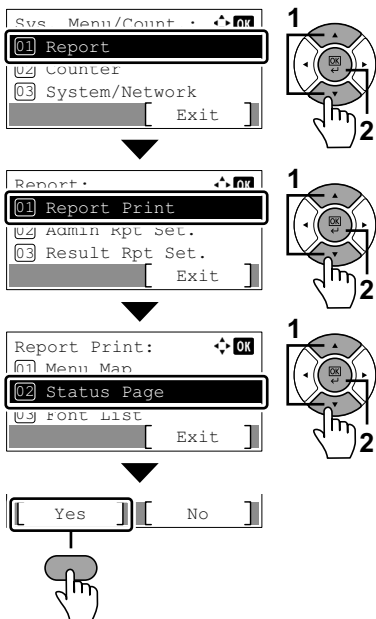

CA

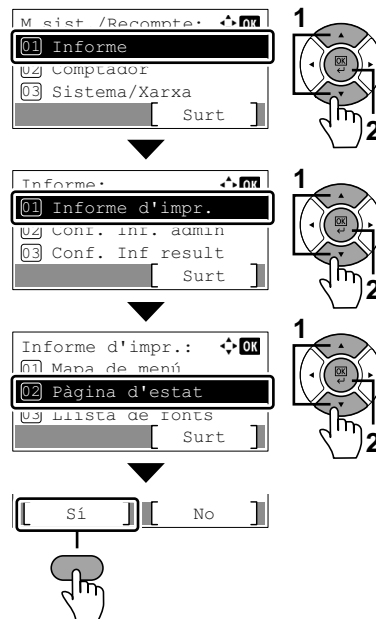

CS

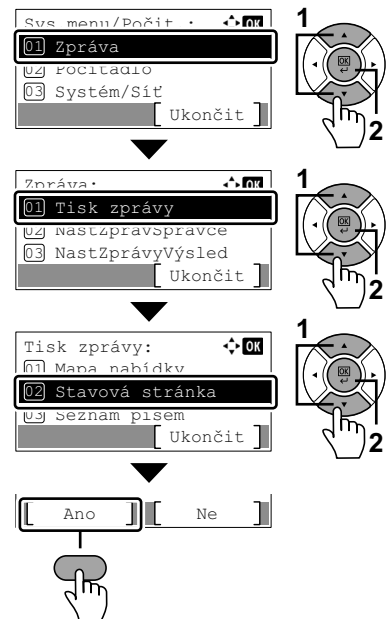

DA

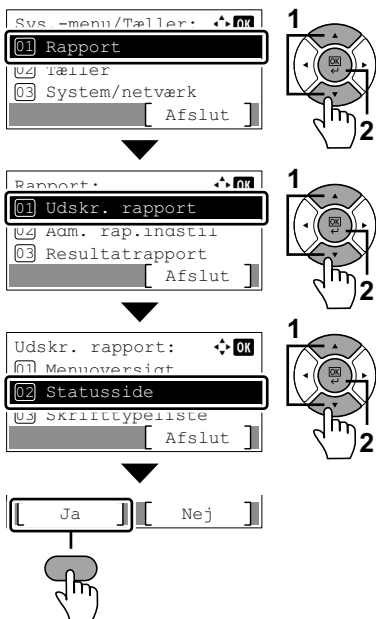

DE

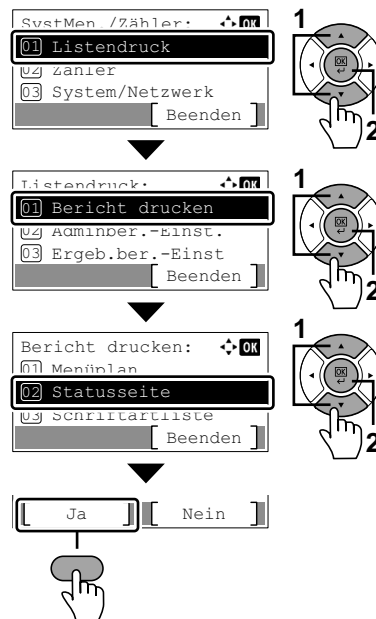

EL

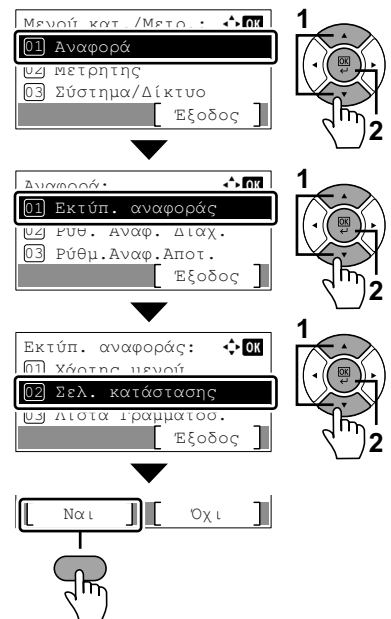

**ES**

Menú Sist /cont :

01 Informe 1

04 Contador 2

03 Sistema/red 2

[ Salir ]

Informe:

01 Impres. informe 1

04 Conf infOR admin 2

03 Conf inf result. 2

[ Salir ]

Impres. informe:

01 Diagrama menú 1

02 Página de estado 1

03 Lista de fuentes 2

[ Salir ]

[ Sí ] [ No ]

**FI**

Järvi val/määrä :

01 Raportti 1

04 Laskuri 2

03 Järj./Verkko 2

[ Poistu ]

Raportti:

01 Raportin tul. 1

04 valv.rap. as. 2

03 Tulosrap. As. 2

[ Poistu ]

Raportin tul.:

01 Valikkokartta 1

02 Tilasivu 1

03 fonttiuutteio 2

[ Poistu ]

[ Kyllä ] [ Ei ]

**FR**

Menu syst/Comptr :

01 Rapport 1

04 Compteur 2

03 Système/réseau 2

[ Quitter ]

Rapport:

01 Imprimer rapport 1

04 Param.rapp.admin 2

03 Param.rapp.résul 2

[ Quitter ]

Imprimer rapport:

01 Plan menu 1

02 Page d'état 1

03 Liste polices 2

[ Quitter ]

[ Oui ] [ Non ]

**HU**

Rend menü/száml :

01 Jelentés 1

04 Számiaio 2

03 Rendszer/Hálózat 2

[ Kilépés ]

Jelentés:

01 Jelentés nyomt. 1

04 Adm. jel. beall. 2

03 Visszaig. jel. 2

[ Kilépés ]

Jelentés nyomt.:

01 Menü tárkén 1

02 Állapotoldal 1

03 Fontkeszletek 2

[ Kilépés ]

[ Igen ] [ Nem ]

**IT**

Cont/menu sist :

01 Rapporto 1

04 Contatore 2

03 Sistema/Rete 2

[ Esci ]

Rapporto:

01 Stampa rapporto 1

04 Imp. rapp Admin. 2

03 Imp. rapp. Risul 2

[ Esci ]

Stampa rapporto:

01 Menu menu 1

02 Pagina stato 1

03 Bienco caratteri 2

[ Esci ]

[ Sì ] [ No ]

**NL**

Svs menu/Teller :

01 Rapport 1

04 Teller 2

03 System/Network 2

[ Einde ]

Rapport:

01 Druk rapport af 1

04 Inst.den.rapport 2

03 Inst.result.rapp 2

[ Einde ]

Druk rapport af:

01 Menu overzicht 1

02 Statuspagina 1

03 Lettertypes 2

[ Einde ]

[ Ja ] [ Nee ]

**NO**

Svs meny/teller :

01 Rapport 1

04 Teller 2

03 System/nettverk 2

[ Ut ]

Rapport:

01 Rapportutskrift 1

04 Rapport:kontroll 2

03 Resultatrapport 2

[ Ut ]

Rapportutskrift:

01 Menuoversikt 1

02 Status 1

03 Skriftliste 2

[ Ut ]

[ Ja ] [ Nei ]

**PL**

Menu svs /licz :

01 Raport 1

04 Licznik 2

03 System/Sieć 2

[ Wyjście ]

Raport:

01 Raportuj druk. 1

04 ust. rap. admin. 2

03 Ustaw. rap. wyn. 2

[ Wyjście ]

Raportuj druk.:

01 Menu menu 1

02 Strona stanu 1

03 Lista czcionek 2

[ Wyjście ]

[ Tak ] [ Nie ]

**PT-BR**

Menu/Cont sist :

01 Relatório 1

04 Contador 2

03 Sistema/Rede 2

[ Sair ]

Relatório:

01 Impr. relatório 1

04 Config relat adm 2

03 Aj. relat result 2

[ Sair ]

Impr. relatório:

01 Menu de menus 1

02 Página de status 1

03 Lista de fontes 2

[ Sair ]

[ Sim ] [ Não ]

PT-PT

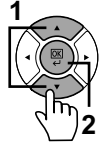
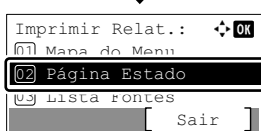
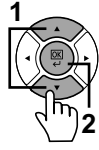
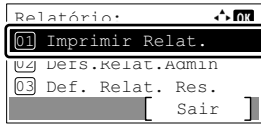
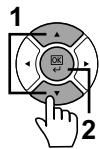
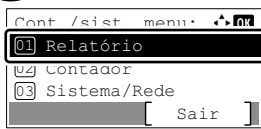

RO

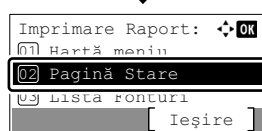
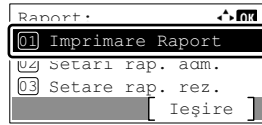
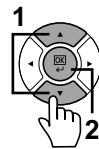
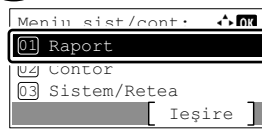

RU

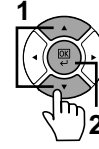
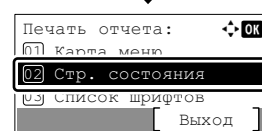
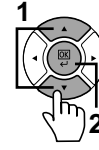
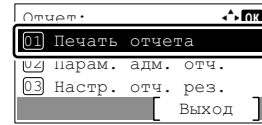
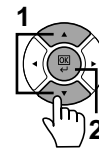
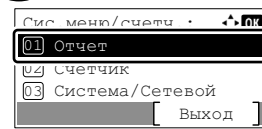

SV

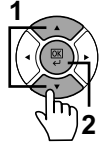
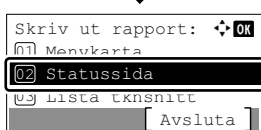
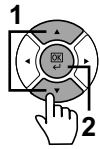
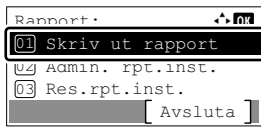
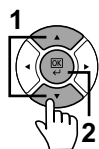
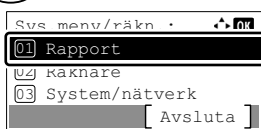

TR

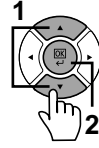
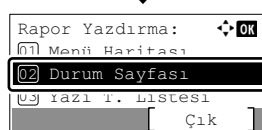
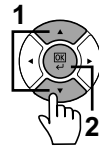
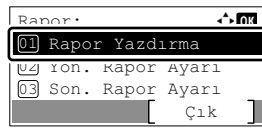
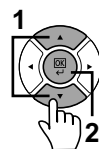
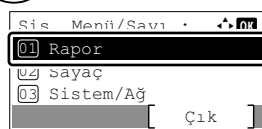

AR

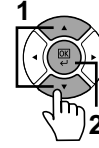
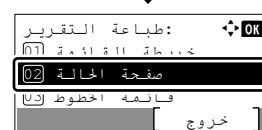
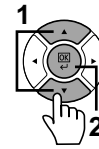
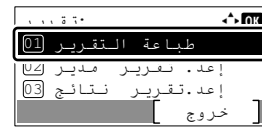
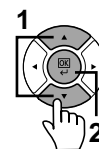
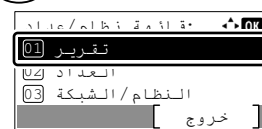

## J Install Drivers and Utilities

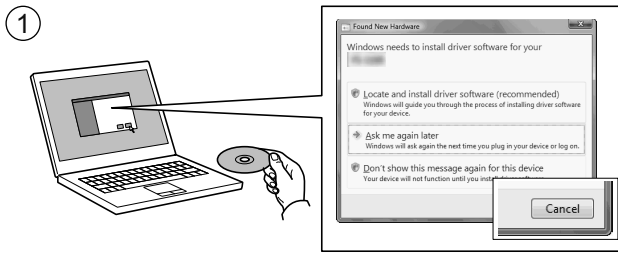

- ①
- ① EN If Found new Hardware window appears, click Cancel.
  - ① CA Si es mostra la finestra "Found new Hardware" (S'ha detectat maquinari nou), feu clic a Cancel·la.
  - ① CS Pokud se zobrazí dialogové okno Nalezen nový hardware, klepněte na tlačítko Storno.
  - ① DA Vælg Annuller, hvis dialogboksen Der er fundet ny hardware.
  - ① DE Bitte legen Sie die beiliegende CD ein und folgen Sie den Anweisungen am Bildschirm, falls auf dem Bildschirm die Anzeige 'Neue Hardware gefunden' von Windows erscheint, drücken Sie Abbrechen.
  - ① EL Αν εμφανιστεί το παράθυρο Εύρεση νέου υλικού, κάντε κλικ στο κουμπί Άκυρο.
  - ① ES Si aparece la ventana Nuevo hardware encontrado, haga clic en Cancelar.
  - ① FI Jos näkyyiin tulee Uusi laite löydetty -ikkuna, napsauta Peruuta.
  - ① FR Si la fenêtre Nouveau matériel détecté s'affiche, cliquez sur Annuler.
  - ① HU Ha az Új hardver telepítési ablak megjelenik, kattintson a Mégse gombra.
  - ① IT Se compare la finestra Trovato nuovo hardware, fare clic su Annulla.
  - ① NL Als het dialoogvenster nieuwe hardware gevonden verschijnt, selecteert u Annuleren.
  - ① NO Hvis vinduet Ny maskinvare funnet vises, klikk på Avbryt.
  - ① PL Jeżeli wyświetlone zostanie okno Znaleziono nowy sprzęt, należy kliknąć przycisk Anuluj.
  - ① PT-BR Se a janela Um novo Hardware foi encontrado aparecer, clique em Cancelar.
  - ① PT-PT Se a janela Encontrar Novo Hardware aparecer, clique em Cancelar.
  - ① RO Dacă apare fereastra Found New Hardware, faceți clic pe Cancel.
  - ① RU Если появляется окно Найдено новое аппаратное обеспечение, щелкните Отменить.
  - ① SV Om Dialogfönstret visar 'Hittade ny hårdvara' klicka då på Avbryt.
  - ① TR Yeni Donanım Bulundu penceresi görüntülenirse, İptal'i tıklatın.
  - ① AR إذا ظهرت نافذة تم العثور على جهاز جديد ، انقر على إلغاء.

2

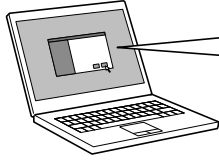

- EN** Follow the instructions in the installation wizard.
- CA** Seguiu les instruccions de l'auxiliar d'instal·lació.
- CS** Řiďte se pokyny v průvodci instalací.
- DA** Følg instruktionerne i installationsguiden.
- DE** Folgen Sie den Anweisungen des Schnelleinstellung Assistenten.
- EL** Ακολουθήστε τις οδηγίες στον οδηγό εγκατάστασης.
- ES** Siga las instrucciones del asistente de instalación.
- FI** Noudata asennusohjelman ohjeita.
- FR** Suivre les instructions de l'assistant d'installation.
- HU** Kövesse a telepítő varázsló utasításait.
- IT** Attenersi alle istruzioni della procedura guidata di installazione.
- NL** Volg de instructies in de installatiewizard.
- NO** Følg instruksjonene i installasjonsveiledningen.
- PL** Postępuj zgodnie z instrukcjami wyświetlanymi w oknie kreatora instalacji.
- PT-BR** Siga as instruções no assistente de instalação.
- PT-PT** Siga as instruções no assistente de instalação.
- RO** Urmați instrucțiunile expertului de instalare.
- RU** Следуйте инструкциям в окне мастера установки.
- SV** Följ anvisningarna i installationsguiden.
- TR** Kurulum sihirbazındaki talimatları izleyiniz.
- AR** اتبع تعليمات معالج التثبيت.

**EN** Login User Name: 4500  
Login Password: 4500

**NL** Aanmeld.gebr.nm: 4500  
Aanmeld.wachtw.: 4500

**CA** Nom inici sessió: 4500  
Contrasenya: 4500

**NO** Pålogg.brukernvn: 4500  
Passord: 4500

**CS** Přihl.uživ.jméno: 4500  
Přihl. Heslo: 4500

**PL** Nazwa logowania: 4500  
Hasło logowania: 4500

**DA** Login brugernavn: 4500  
Login adg.kode: 4500

**PT-BR** Usuário login: 4500  
Senha de login: 4500

**DE** Login-Name: 4500  
Login-Password: 4500

**PT-PT** N.Util.Iníc.Ses.: 4500  
P.pass.Iníc.Ses.: 4500

**EL** Σύνδ./Οv. Χρήστη: 4500  
Κωδ.Πρόσβ.Σύνδ.: 4500

**RO** Nume utilizator: 4500  
Parolă Conectare: 4500

**ES** Nom. us. in. ses: 4500  
Contr. in. ses.: 4500

**RU** Имя польз. д/вх.: 4500  
Пароль при входе: 4500

**FI** Kirj. Käytt.nimi: 4500  
Kirj. salasana: 4500

**SV** Användarnamn: 4500  
Inloggn.lösenord: 4500

**FR** Login nom utilis: 4500  
Login mot passe: 4500

**TR** O. Açma Kul. Adı: 4500  
O. Açma Parolası: 4500

**HU** Bej. Felh. név: 4500  
Bej. jelszó: 4500

**AR**

اسم الدخول : 4500  
كلمة مرور الدخول : 4500

**IT** Nome uten. login: 4500  
Password login: 4500



①

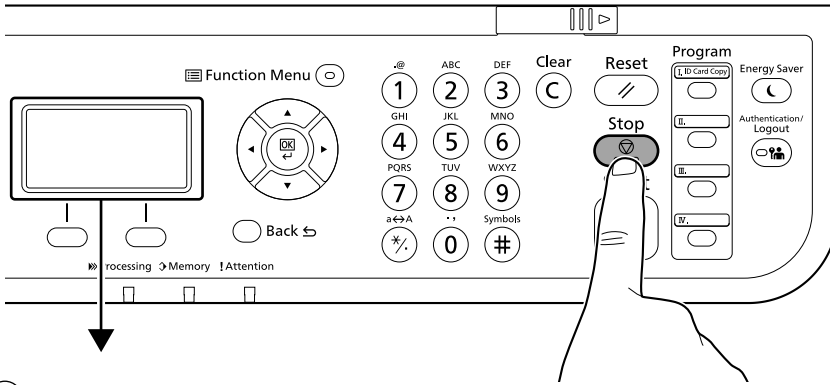

②

EN

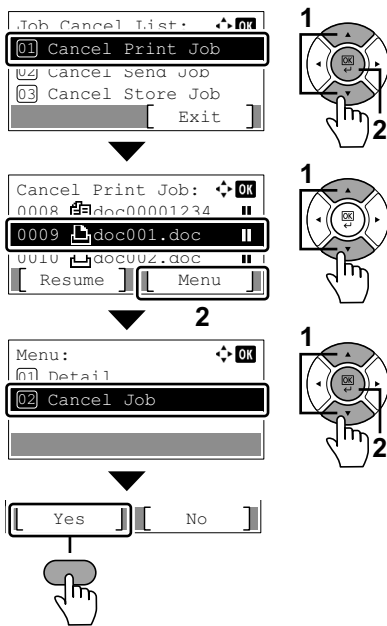

CA

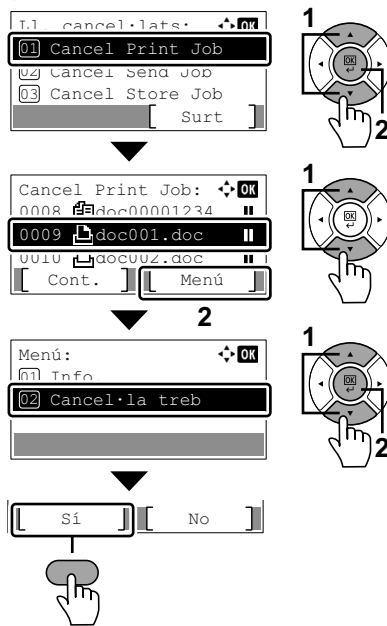

CS

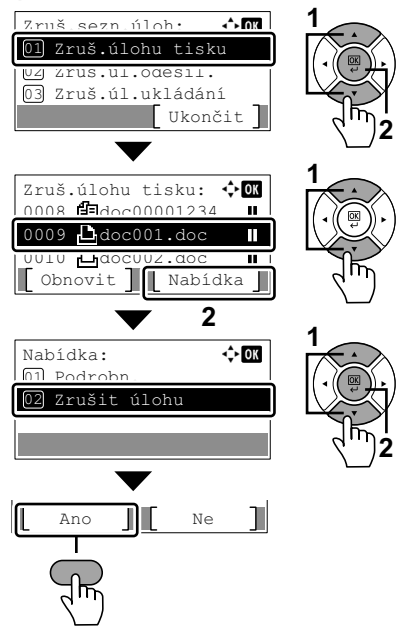

DA

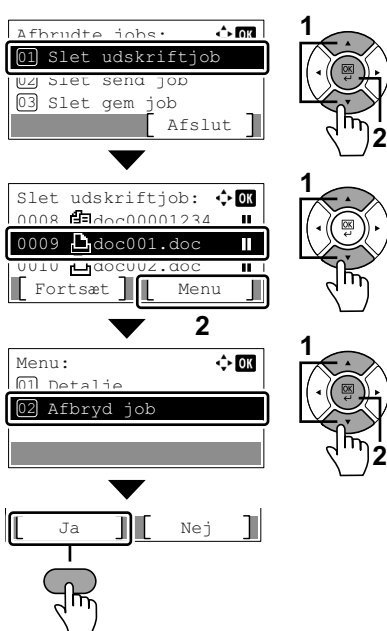

DE

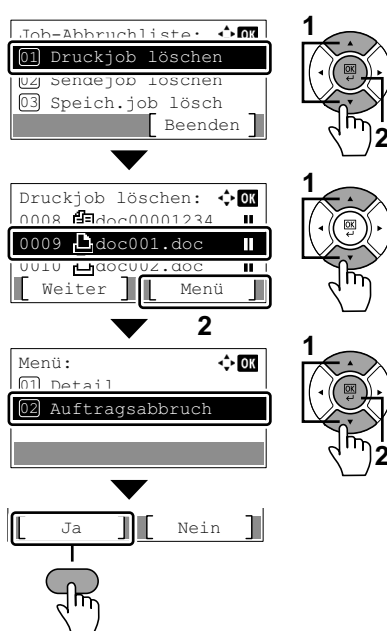

EL

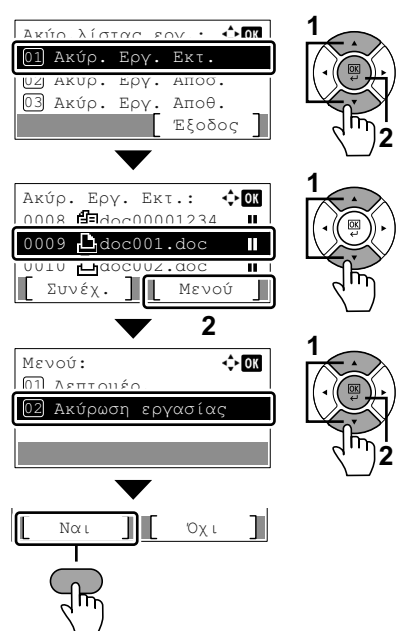

ES

Listo canc. trb. : OK  
01 Canc. trb. impr.  
02 Canc. trb. envio  
03 Canc. trb. almc.  
[ Salir ]

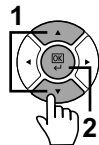

Canc. trb. impr.: OK  
0008 doc0001234 II  
0009 doc001.doc II  
0010 doc002.doc II  
[ Reanudar ] [ Menú ]

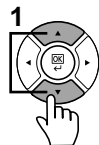

Menú: OK  
01 Detalle  
02 Cancel. trabajo  
[ Salir ]

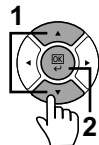

[ Sí ] [ No ]



FI

Tuä peruuttu lis. : OK  
01 Peru tulostus  
02 Peru lanetys  
03 Peru tallennus  
[ Poistu ]

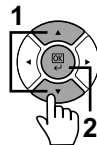

Peru tulostus: OK  
0008 doc0001234 II  
0009 doc001.doc II  
0010 doc002.doc II  
[ Jatka ] [ Valikko ]

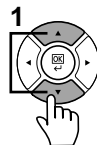

Valikko: OK  
01 Lisätiedot  
02 Työn peruutus  
[ Salir ]

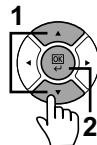

[ Kyllä ] [ Ei ]



FR

Liste trav annul. : OK  
01 Annuler impr.  
02 Annuler envoi  
03 Annuler stockage  
[ Quitter ]

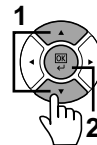

Annuler impr.: OK  
0008 doc0001234 II  
0009 doc001.doc II  
0010 doc002.doc II  
[ Reprise ] [ Menu ]

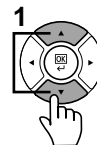

Menu: OK  
01 Détails  
02 Annul. travaux  
[ Salir ]

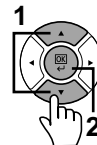

[ Oui ] [ Non ]



HU

Fldt visszvon l. : OK  
01 Nyomt. megszakít  
02 Kuldes megszakít  
03 Tárol. megszakít  
[ Kilépés ]

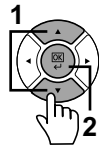

Nyomt. megszakít: OK  
0008 doc0001234 II  
0009 doc001.doc II  
0010 doc002.doc II  
[ Folytat ] [ Menü ]

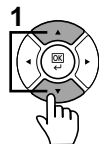

Menü: OK  
01 Részletek  
02 Feladat visszav.  
[ Salir ]

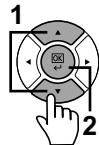

[ Igen ] [ Nem ]



IT

lista annull Job. : OK  
01 Annulla stampa  
02 Annulla invio  
03 Annulla memoriz.  
[ Esci ]

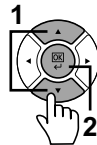

Annulla stampa: OK  
0008 doc0001234 II  
0009 doc001.doc II  
0010 doc002.doc II  
[ Ripresa ] [ Menu ]

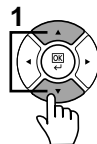

Menu: OK  
01 Dettagli  
02 Annulla lavoro  
[ Salir ]

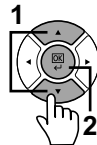

[ Sì ] [ No ]



NL

Liist ann. taken. : OK  
01 Afdr.taak annul.  
02 Verz.taak annul.  
03 Opsl.taak annul.  
[ Einde ]

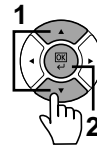

Afdr.taak annul.: OK  
0008 doc0001234 II  
0009 doc001.doc II  
0010 doc002.doc II  
[ Hervat ] [ Menu ]

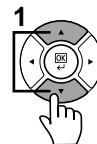

Menu: OK  
01 Details  
02 Taak annuleren  
[ Salir ]

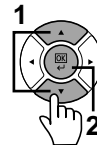

[ Ja ] [ Nee ]



NO

Jobbavbruddliste: OK  
01 Avbryt utsk.jobb  
02 Avbryt sendjobb  
03 Avbryt lagrejobb  
[ Ut ]

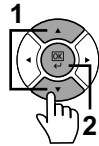

Avbryt utsk.jobb: OK  
0008 doc0001234 II  
0009 doc001.doc II  
0010 doc002.doc II  
[ Gjenop. ] [ Meny ]

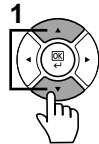

Meny: OK  
01 Detalier  
02 Jobbavbrudd  
[ Salir ]

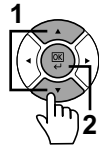

[ Ja ] [ Nei ]



PL

Listo anul. zadani: OK  
01 Anul. zad. druk.  
02 Anul. zad. wys.  
03 Anul. zad. zap.  
[ Wyjście ]

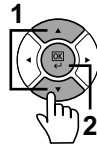

Anul. zad. druk.: OK  
0008 doc0001234 II  
0009 doc001.doc II  
0010 doc002.doc II  
[ Wznów ] [ Menu ]

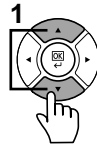

Menu: OK  
01 Szczegóły  
02 Anulowanie zad.  
[ Salir ]

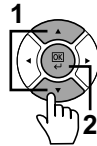

[ Tak ] [ Nie ]



PT-BR

Listo canc. trab. : OK  
01 Canc. trab. imp.  
02 Canc. trab. env.  
03 Canc. trab. arm.  
[ Sair ]

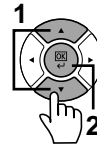

Canc. trab. imp.: OK  
0008 doc0001234 II  
0009 doc001.doc II  
0010 doc002.doc II  
[ Retomar ] [ Menu ]

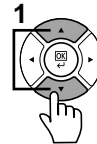

Menu: OK  
01 Detalhe  
02 Cancelar trab.  
[ Salir ]

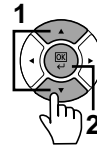

[ Sim ] [ Não ]



PT-PT

Lista Canc Trabs: OK  
01 Canc. Tra. Impr.  
02 Canc. Envio tra.  
03 Canc. Arm. Trab.  
Sair

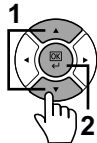

Canc. Tra. Impr.: OK  
0008 doc00001234  
0009 doc001.doc  
0010 doc002.doc  
Contin. Menu

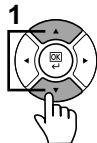

Menu: OK  
01 Detalhe  
02 Canc. Trabalho

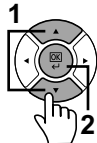

Sim Não



RO

Ist anul lucr: OK  
01 Anulare printare  
02 Anulare transm.  
03 Anulare stocare  
Iesire

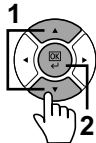

Anulare printare: OK  
0008 doc00001234  
0009 doc001.doc  
0010 doc002.doc  
Reluare Menu

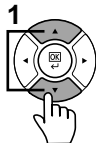

Menu: OK  
01 Detalii  
02 Anulare Lucrare

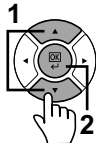

Da Nu



RU

Список отм зап: OK  
01 Отменить печать  
02 Отмена отправки  
03 Отмена хранения  
Выход

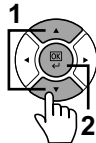

Отменить печать: OK  
0008 doc00001234  
0009 doc001.doc  
0010 doc002.doc  
Продол. Menu



Меню: OK  
01 Сведения  
02 Отмена задания

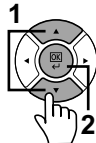

Да Нет



SV

Lista avbr jobb: OK  
01 Avbryt utskrift  
02 Avbr skicka jobb  
03 Avbr lagra jobb  
Avsluta

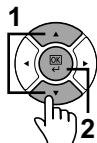

Avbryt utskrift: OK  
0008 doc00001234  
0009 doc001.doc  
0010 doc002.doc  
Uppta Meny

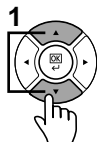

Meny: OK  
01 Uppgift  
02 Jobb avbrutet

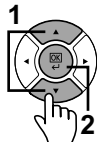

Ja Nej



TR

İş İptal Listesi: OK  
01 Baskı işi iptal  
02 Gönder. işi iptal  
03 Saklanan iş İptal  
Çık

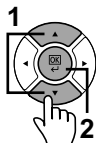

Baskı işi iptal: OK  
0008 doc00001234  
0009 doc001.doc  
0010 doc002.doc  
Devam Menü

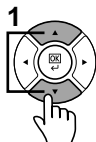

Menü: OK  
01 Avranta  
02 İş İptal

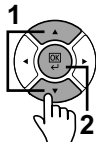

Evet Hayır



AR

قائمة إلغاء مهمة: OK  
01 إلغاء مهمة طباعة  
02 إلغاء مهمة إرسال  
03 إلغاء مهمة تخزين  
خروج

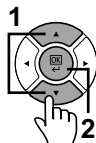

إلغاء مهمة طباعة: OK  
0008 doc00001234  
0009 doc.001doc  
0010 doc.002doc  
قائمة استئناف



القائمة: OK  
01 التفتيح  
02 إلغاء المهمة

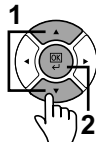

نعم لا



①

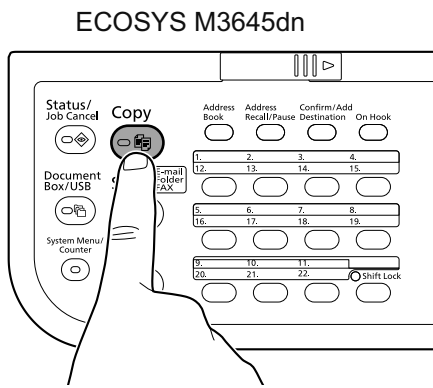

ECOSYS M3145dn

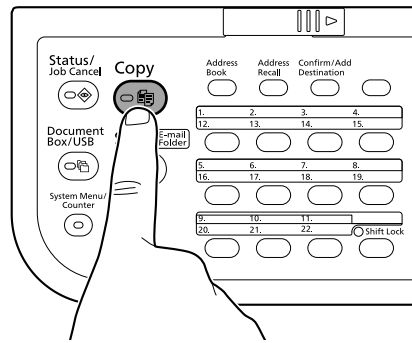

②

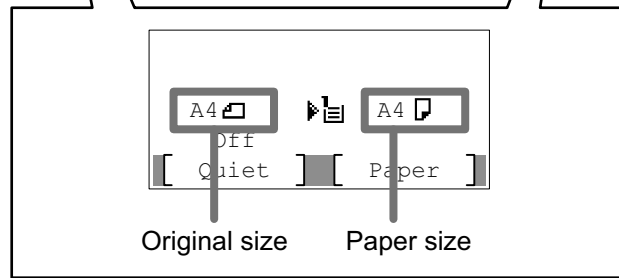
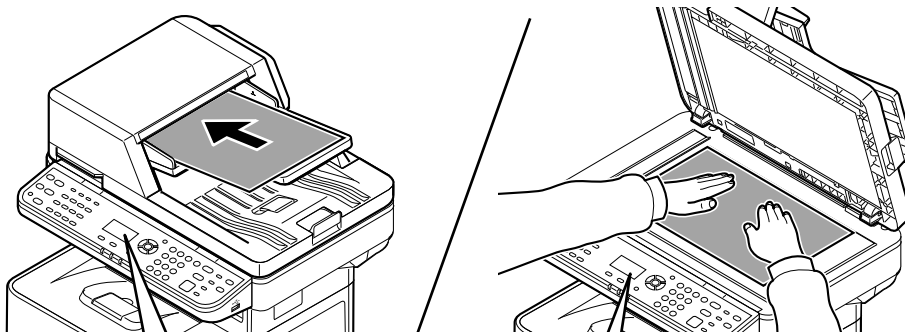

③

④

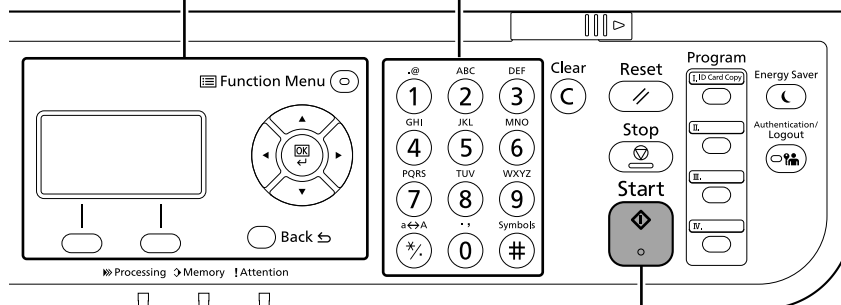

⑤

## Setup

EN

- 1 Launch your Web browser.
- 2 In the Address or Location bar, enter the machine's IP address or Printer Host Name.

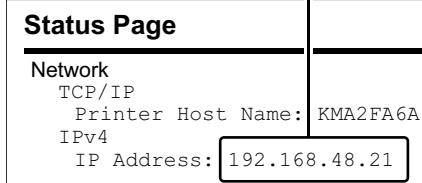

- 3 Enter the following and log in to Command Center RX with administrator authority.

Admin Login	User Name	Admin
	Password	Admin
	Login	

- 4 From the [Function Settings] menu, click [E-mail].
- 5 Set SMTP Protocol [On], and then enter the following items.
  - SMTP Server Name
  - E-mail Size Limit
  - Sender Address

CA

- 1 Inicieu el navegador web.
- 2 A la barra d'adreesos o d'ubicació, introduïu l'adreça IP del dispositiu o el nom de l'amfitrió de la impressora.

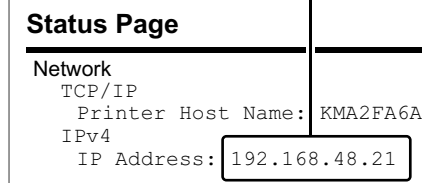

- 3 Introduïu les dades següents i inicieu la sessió a Command Center RX amb privilegis d'administrador.

Inicia sessió com a administrador	Nom d'usuari	Admin
	Contrasenya	Admin
	Inicia sessió	

- 4 Al menú [Configuració de funcions], feu clic a [E-mail].
- 5 Establiu el Protocol SMTP en [Activat] i introduïu les dades següents.
  - Nom del servidor SMTP
  - Límit de mida de l'E-mail
  - Adreça del remitent

CS

- 1 Spust'te váš webový prohlížeč.
- 2 V záložce Adresa nebo Umístění zadejte IP adresu zařízení nebo jméno hostitelské tiskárny.

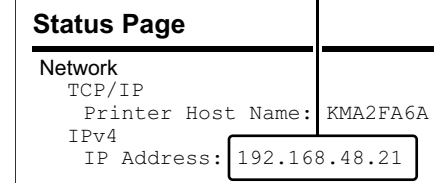

- 3 Zadejte níže uvedené informace a přihlaste se do Command Center RX s administrátorským oprávněním.

Přihlášení správce	Uživatelské jméno	Admin
	Heslo	Admin
	Přihlášení	

- 4 V nabídce [Nastavení funkcí] klikněte na [E-mail].
- 5 Nastavte protokol SMTP na [Zapnuto], a poté zadejte následující položky.
  - Název serveru SMTP
  - Limit velikosti e-mailu
  - Adresa odesílatele

DA

- 1 Start din webbrower.
- 2 Indtast maskinens IP-adresse eller printerens værtsnavn i adresse- eller placeringslinjen.

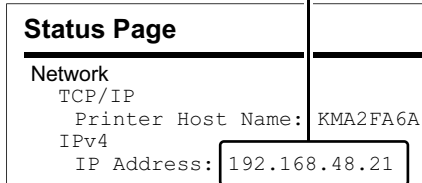

- 3 Indtast følgende og log ind i Command Center RX med administratorrettigheder.

Administratorlogon	Brugernavn	Admin
	Adgangskode	Admin
	Log på	

- 4 I menuen [Funktionsindstillinger], klik på [E-mail].
- 5 Indstil SMTP-protokol til [Til], og indtast derpå følgende enheder.
  - SMTP-servernavn
  - Størrelsesbegrænsning på e-mails
  - Afsenderadresse

DE

- 1 Starten Sie Ihren Webbrowser.
- 2 In der Adresszeile geben Sie die IP-Adresse des Geräts oder den Hostnamen wie eine Internetadresse (URL) ein.

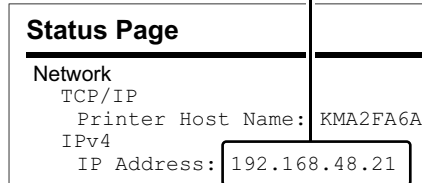

- 3 Geben Sie Folgendes ein und melden sich am Command Center RX mit Administrator-Rechten an.

Admin Anmeldung	Anwendername	Admin
	Passwort	Admin
	Anmelden	

- 4 Im Menü [Funktions-Einstellungen] klicken Sie auf [E-Mail].
- 5 Stellen Sie das SMTP-Protokoll auf [Ein] und geben Sie die folgenden Punkte ein.
  - SMTP-Servername
  - E-Mail-Größenlimit
  - Absenderadresse

EL

- 1 Εκκινήστε το πρόγραμμα περιήγησής σας στο Internet.
- 2 Στο πλαίσιο Διεύθυνση ή Τοποθεσία, εισάγετε τη διεύθυνση IP του μηχανήματος ή το όνομα του κεντρικού εκτυπωτή.

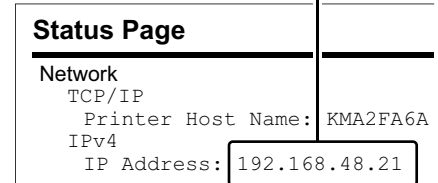

- 3 Εισάγετε τα ακόλουθα και συνδεθείτε στο Command Center RX με δικαιώματα διαχειριστή.

Σύνδεση Διαχειριστή	Όνομα χρήστη	Admin
	Κωδικός πρόσβασης	Admin
	Σύνδεση	

- 4 Από το μενού [Ρυθμίσεις Λειτουργιών], κάντε κλικ στο [E-mail].
- 5 Ρυθμίστε το Πρωτόκολλο SMTP σε [Ενεργοποίηση], και έπειτα εισάγετε τα ακόλουθα στοιχεία.
  - Όνομα διακομιστή SMTP
  - Όριο μεγέθους e-mail
  - Διεύθυνση επιστολέα

ES

- 1 Inicie el explorador de Internet.
- 2 En la barra de direcciones o de ubicación, introduzca la dirección IP de la máquina o el nombre de host de la impresora.

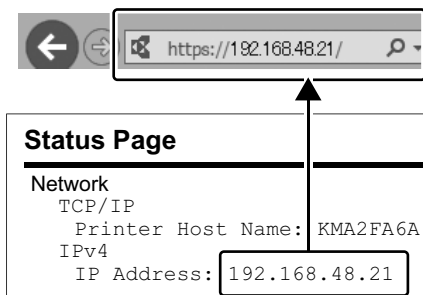

- 3 Introduzca lo siguiente e inicie sesión en Command Center RX con autoridad de administrador.

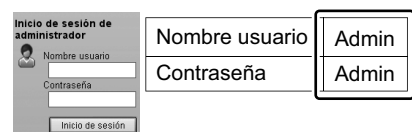

- 4 En el menú [Configuración de función], haga clic en [E-mail].

- 5 Configure Protocolo SMTP como [Activado] y después introduzca los valores de los siguientes elementos.

- Nombre de servidor SMTP
- Tam. lím. e-m.
- Dirección del remitente

FI

- 1 Käynnistä verkkoselaimesi.
- 2 Kirjoita IP-osoite osoiteriville tai sijaintipalkkiin tietokoneen tai tulostinpalvelimen isäntänimi.

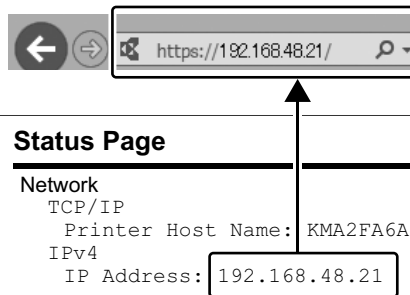

- 3 Syötä seuraava, ja kirjaudu Command Center RX:ään ylläpitäjän tunnuksilla.

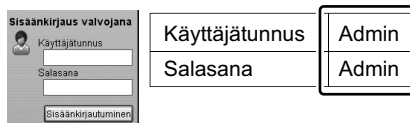

- 4 Klikkaa [Sähköposti] [Toimintoasetus] -valikosta.

- 5 Aseta SMTP-protokolla [Käytössä] -asentoon ja syötä seuraavat tiedot.

- SMTP-palvelimen nimi
- Sähköpostin kokorajoitus
- Lähettäjän osoite

FR

- 1 Lancer le navigateur Internet.
- 2 Dans la barre d'adresses ou d'emplacement, saisir l'adresse IP de la machine ou le nom d'hôte de l'imprimante.

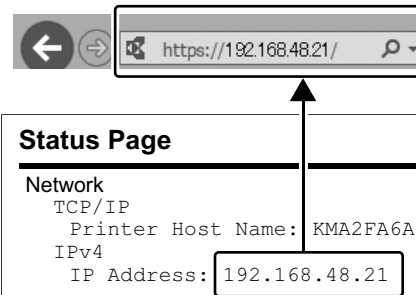

- 3 Saisir les informations suivantes et se connecter à Command Center RX avec des droits d'administrateur.

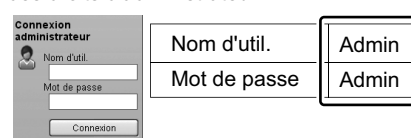

- 4 Dans le menu [Paramètres de fonction], cliquer sur [E-mail].

- 5 Régler le protocole SMTP sur [Activé], puis saisir les informations suivantes.

- Nom de serveur SMTP
- Lim. taille e-mail
- Adresse de l'expéditeur

HU

- 1 Indítsa el a webböngészőjét.
- 2 A címsorba vagy a hely sávjába írja be a készülék IP címét vagy a nyomtató állomásnevét.

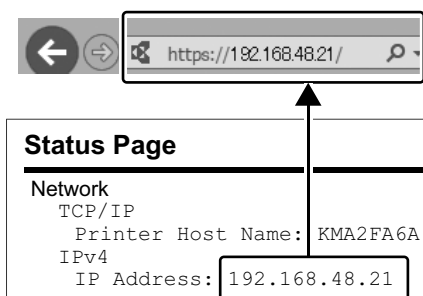

- 3 Írja be az alábbiakat, és rendszergazdai jogosultságokkal jelentkezzen be a Command Center RX alkalmazásba.

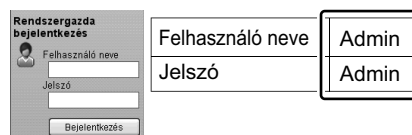

- 4 A [Funkcióbeállítások] menüben kattintson az [E-mail] lehetőségre.

- 5 Az SMTP protokoll opciót kapcsolja [Be], és adja meg az alábbi tételeket.

- SMTP-szerver neve
- E-mail méretkorlátozása
- Feladó címe

IT

- 1 Avviare il browser web.
- 2 Nella barra degli indirizzi, immettere l'indirizzo IP della macchina oppure il Nome host della stampante.

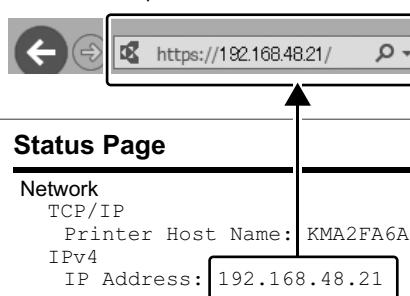

- 3 Immettere le seguenti voci e accedere a Command Center RX con privilegi di amministratore.

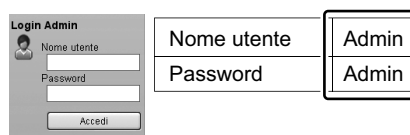

- 4 Nel menu [Impostazioni di funzione], fare clic su [Posta elettronica].

- 5 Impostare Protocollo SMTP su [On], quindi immettere le seguenti voci.

- Nome server SMTP
- Limite dim. email
- Indirizzo mittente

NL

- 1 Start uw webbrower.
- 2 In de adres-of locatiebalk, voer het IP-adres van het apparaat of printer hostnaam in.

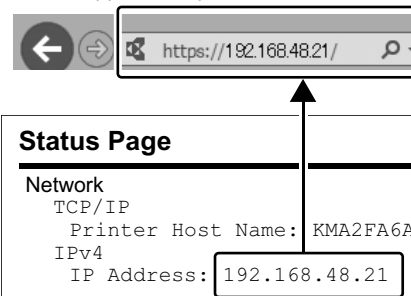

- 3 Voer het volgende in en meld u aan bij Command Center RX met beheerdersrechten.

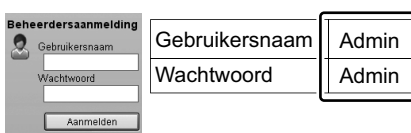

- 4 In het menu [Functie-instellingen], klik op [E-mail].

- 5 Stel SMTP-protocol in op [Aan] en voer vervolgens de volgende items in.

- SMTP-servernaam
- Groottebeperking e-mail
- Adres afzender

NO

- 1 Åpne webleseren din.
- 2 Legg inn maskinens IP-adresse eller skriverens vertsnavn i adresselinjen.

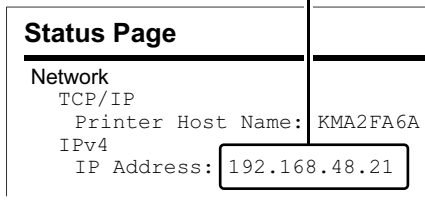

- 3 Tast inn følgende og logg deg på Command Center RX med administratorrettigheter.

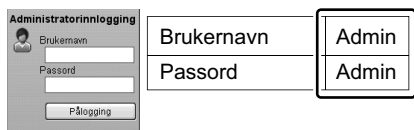

- 4 Fra menyen [Funksjoninnstillinger], klikk på [E-post].
- 5 Sett SMTP-protokoll [På], og tast deretter inn følgende elementer.
  - SMTP-servernavn
  - Størrelsesgrense for e-post
  - Avsenderadresse

PL

- 1 Uručom przeglądarkę internetową.
- 2 W polu na pasku adresu lub lokalizacji wprowadź adres IP urządzenia lub nazwę hosta drukarki.

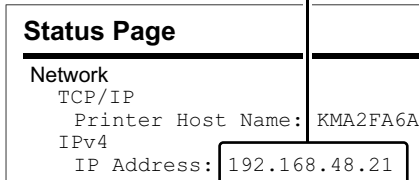

- 3 Wprowadź następujące poświadczenia, aby zalogować się do narzędzia Command Center RX na konto z uprawnieniami administratora.

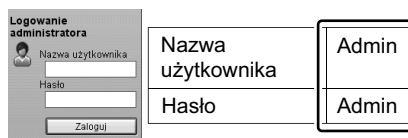

- 4 Z menu [Ustawienia funkcji] wybierz polecenie [E-mail].
- 5 Dla ustawienia Protokół SMTP wybierz wartość [Wi.], a następnie wprowadź wartości następujących ustawień.
  - Nazwa serwera SMTP
  - Limit rozmiaru e-mail
  - Adres nadawcy

PT-BR

- 1 Inicie o seu navegador web.
- 2 Na barra Endereço ou Local, insira o endereço de IP da máquina ou o nome do host da impressora.

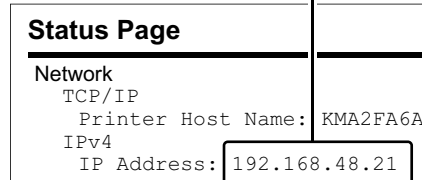

- 3 Insira o seguinte e faça o login no Command Center RX com autoridade de administrador.

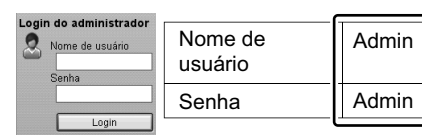

- 4 No menu [Configurações da função], clique em [E-mail].
- 5 Defina o Protocolo SMTP como [Ativado] e depois insira os seguintes itens.
  - Nome do servidor de SMTP
  - Lim.tam. p/e-mail
  - Endereço do remetente

PT-PT

- 1 Abra o seu browser.
- 2 Na barra de endereço ou localização insira o endereço IP da máquina ou Nome de Anfitrião da Impressora.

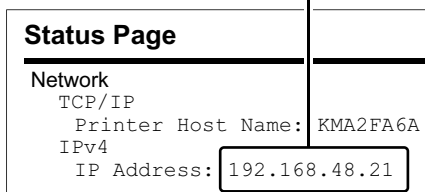
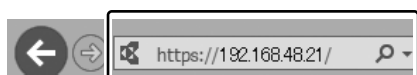

- 3 Insira o seguinte e inicie sessão no Command Center RX com permissão de administrador.

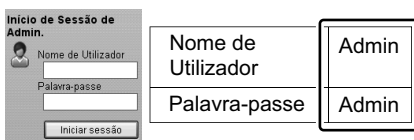

- 4 A partir do menu [Definições da função], clique em [E-mail].
- 5 Defina o Protocolo SMTP para [Ligado] e insira os seguintes itens.
  - Nome do Servidor SMTP
  - Limite de Tamanho de E-mail
  - Endereço do Destinatário

RO

- 1 Lansați browserul dvs. de internet.
- 2 În bara de adresă sau poziție, introduceți adresa IP a aparatului sau numele de gazdă al imprimantei.

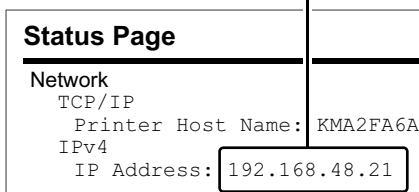

- 3 Introduceți următoarele și conectați-vă la Command Center RX cu autoritate de administrator.

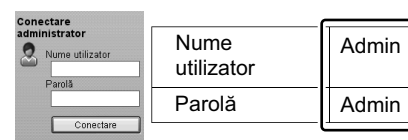

- 4 Din meniul [Setări funcționale], faceți clic pe [E-mail].
- 5 Setări Setări Protocol SMTP pe [Pornit], și apoi introduceți următoarele elemente.
  - Nume server SMTP
  - Limită dimensiune e-mail
  - Adresă expeditor

RU

- 1 Запустите веб-обозреватель.
- 2 В строке «Адрес» или «Местоположение» введите IP-адрес аппарата или имя хоста принтера.

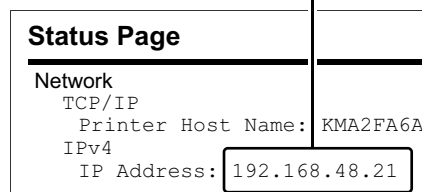

- 3 Введите следующие данные и выполните вход в систему Command Center RX с правами администратора.

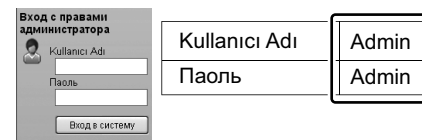

- 4 В меню [Настройки функций] выберите [Электронная почта].
- 5 Для протокола SMTP Установите [Вкл.], а затем введите следующие данные.
  - Имя сервера SMTP
  - Предел размера сообщения эл. почты
  - Адрес отправителя

SV

- 1 Starta din webbläsare.
- 2 Skriv in maskinens IP-adress eller skrivarens värddamn i adressfältet.

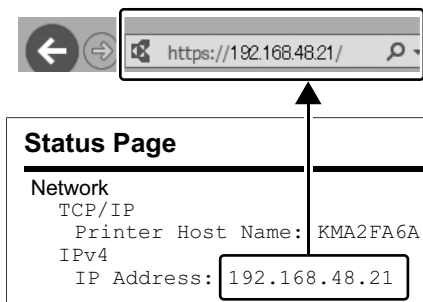

- 3 Skriv in följande och logga in i Command Center RX som administratör.

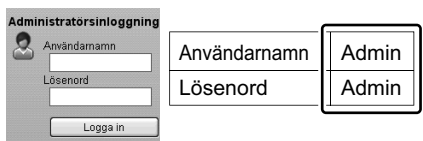

- 4 Från menyn [Funktionsinställningar], klicka på [E-post].
- 5 Aktivera SMTP-protokoll [På], och skriv sedan in följande uppgifter.
  - SMTP-servernamn
  - Storleksbegränsning för e-postmeddelanden
  - Avsändaradress

TR

- 1 Web tarayıcınızı açın.
- 2 Adres veya Yer çubuğuna, makinenin IP adresini yazın.

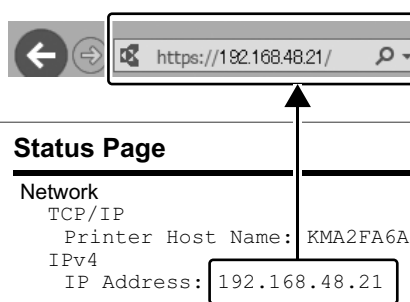

- 3 Aşağıdakileri girin veya yönetici yetkisiyle Command Center RX'de oturum açın.

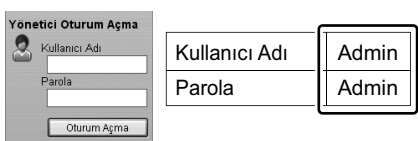

- 4 [Fonksiyon Ayarları] menüsünden, [E-posta] üzerine tıklayın.
- 5 SMTB protokolü ayarını [Açık] konumuna getirin ve sonra aşağıdaki öğeleri yazın.
  - SMTP Sunucu Adı
  - E-posta Boyutu Sınırı
  - Gönderen Adresi

AR

- 1 افتح مستعرض الإنترنت الخاص بك.
- 2 في شريط الموقع أو العنوان، أدخل عنوان IP الخاص بالجهاز أو اسم مضيف الطباعة.

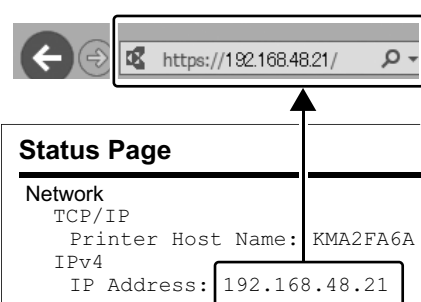

- 3 أدخل ما يلي وسجل للدخول في Command Center RX بامتيازات المدير المسؤول.

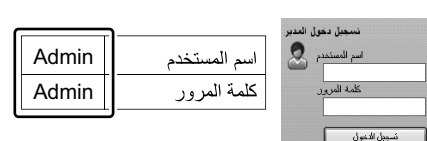

- 4 من القائمة [إعدادات الوظائف]، انقر فوق [البريد الإلكتروني].
- 5 اضبط بروتوكول SMTP على وضع [تشغيل]، ثم أدخل العناصر التالية.
  - اسم ملقم SMTP
  - حدود حجم البريد الإلكتروني
  - عنوان المرسل



# Send

①

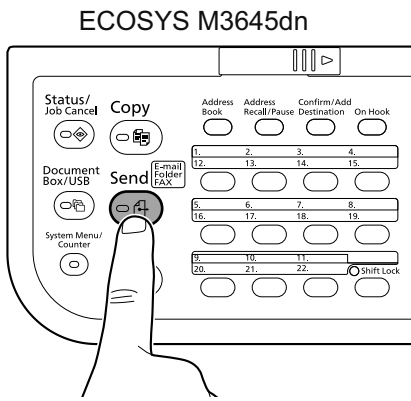

## ECOSYS M3145dn

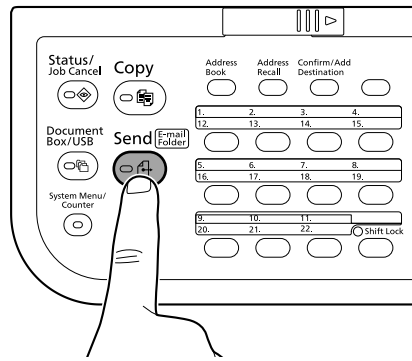

②

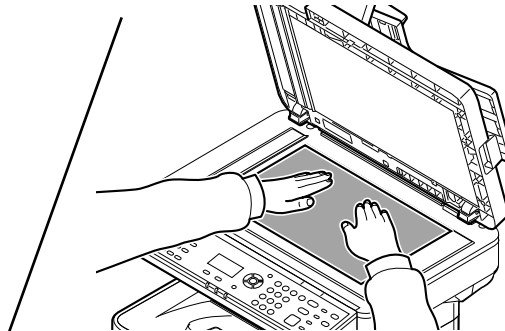
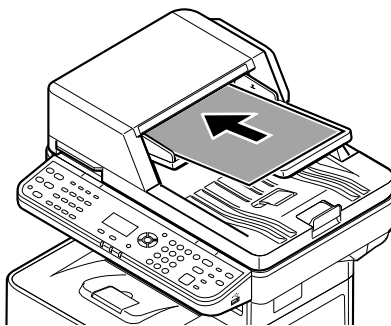

③

EN

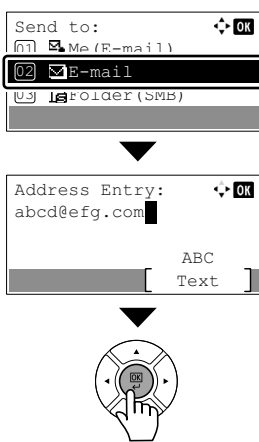

CA

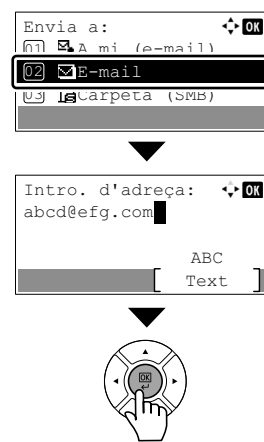

CS

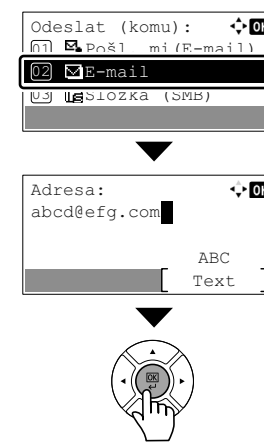

DA

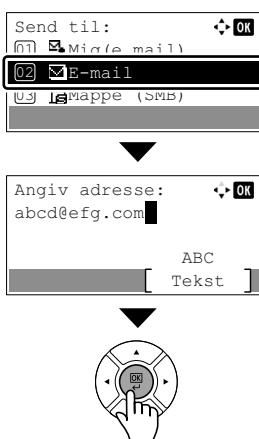

DE

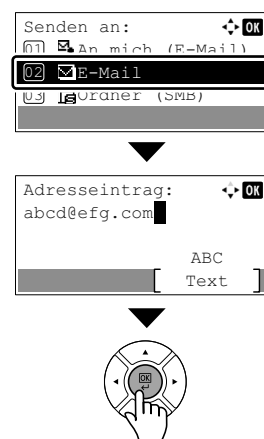

EL

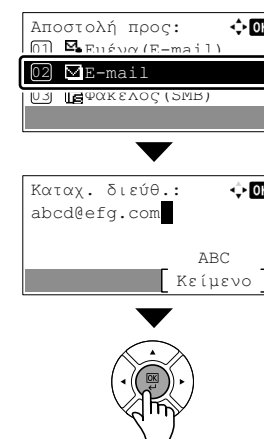

ES

Enviar a: OK

01 Yo (E-mail)

02 E-mail

03 Carpeta (SMB)



Entr. Direc: OK

abcd@efg.com

ABC

Texto



FI

Lähetä: OK

01 Minulle (sähkö)

02 Sähköposti

03 Kansio (SMB)



Osoitt syöttö: OK

abcd@efg.com

ABC

Teksti



FR

Envoyer vers: OK

01 Personne (E-mail)

02 E-mail

03 Dossier (SMB)

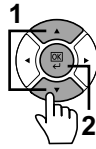

Entrée adresse: OK

abcd@efg.com

ABC

Texte



HU

Címzett: OK

01 Macamnak (E-mail)

02 E-mail

03 Mappa (SMB)

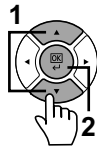

Címbejegyzés: OK

abcd@efg.com

ABC

Szöveg



IT

Invia a: OK

01 A me (E-mail)

02 E-mail

03 Cartella (SMB)

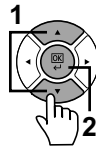

Indirizzo: OK

abcd@efg.com

ABC

Testo

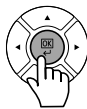

NL

Verzenden naar: OK

01 Mij (E-mail)

02 E-mail

03 Map (SMB)

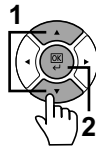

Adresinvoer: OK

abcd@efg.com

ABC

Tekst



NO

Send til: OK

01 Meg (E-post)

02 E-post

03 Mappe (SMB)

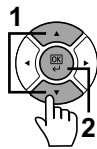

Adresse inng: OK

abcd@efg.com

ABC

Tekst



PL

Wyślij do: OK

01 Do mnie (e-mail)

02 E-mail

03 Folder (SMB)

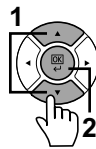

Wpis adresu: OK

abcd@efg.com

ABC

Tekst



PT-BR

Enviar para: OK

01 Eu (E-mail)

02 E-mail

03 Pasta (SMB)

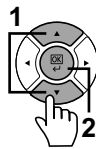

Adic. Entrada: OK

abcd@efg.com

ABC

Texto



PT-PT

Enviar para: OK

01 Mim (E-mail)

02 E-mail

03 Pasta (SMB)



Entr. endereço: OK

abcd@efg.com

ABC

Texto



RO

Trimitere la: OK

01 Mie (E-mail)

02 E-mail

03 Folder (SMB)

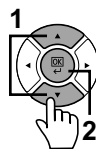

Introd. adresă: OK

abcd@efg.com

ABC

Text



RU

Передать: OK

01 Мне (эл почта)

02 E-mail

03 Папка (SMB)

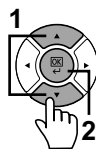

Поле адреса: OK

abcd@efg.com

ABC

Текст



SV

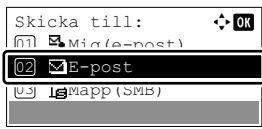

TR

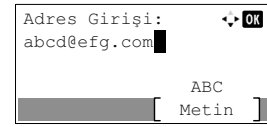
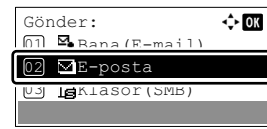

AR

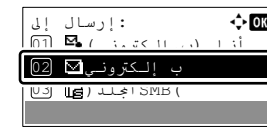

4

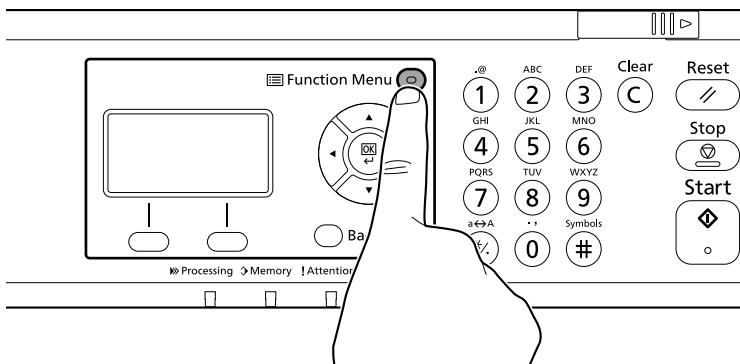

5

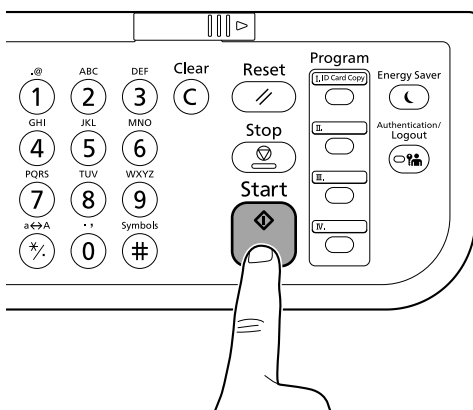

1

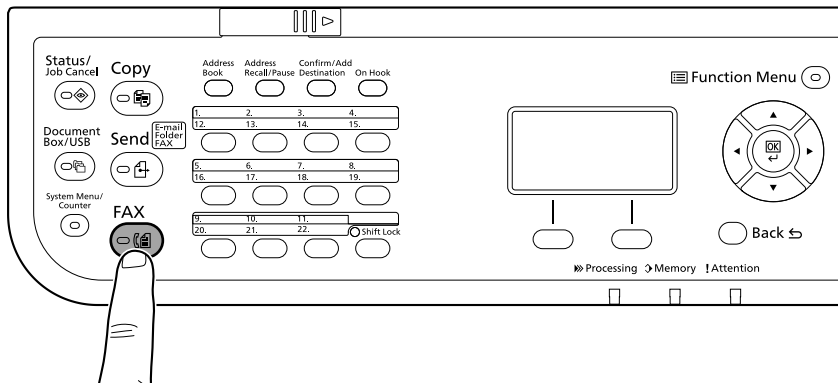

2

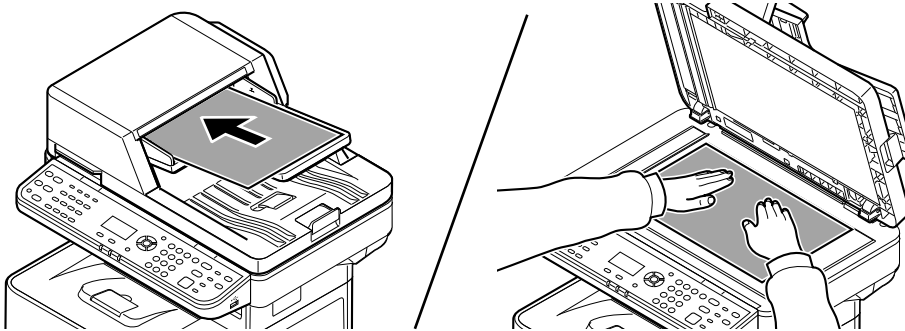

3

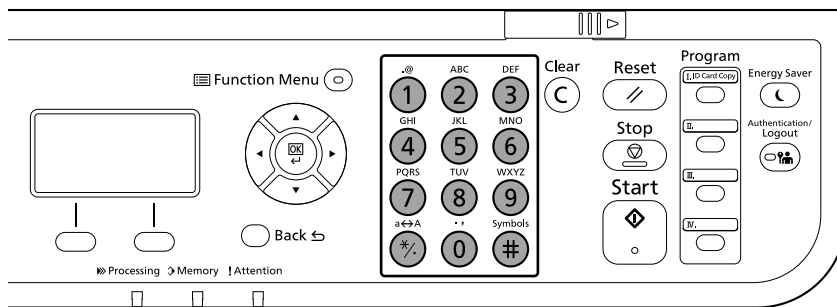

EN

FAX No. Entry: **OK**  
 0123456789 █  
 [ Chain ] [ Detail ]

CA

Intro. n° de FAX: **OK**  
 0123456789 █  
 [ Cadena ] [ Info. ]

CS

Zadání fax. čís.: **OK**  
 0123456789 █  
 [ Řetěz ] [ Podrobn. ]

DA

Angiv faxnr.: **OK**  
 0123456789 █  
 [ Kæde ] [ Detalje ]

DE

Faxnr. invoeren: **OK**  
 0123456789 █  
 [ Keten ] [ Details ]

EL

Εισαγ. Αριθ. ΦΑΞ: **OK**  
 0123456789 █  
 [ Αλυσίδα ] [ Λεπτομ. ]

ES

Ingreso nro. FAX: **OK**  
 0123456789 █  
 [ Cadena ] [ Detalle ]

FI

Kirjfaxsin nro: **OK**  
 0123456789 █  
 [ Ketju ] [ Tiedot ]

FR

Entrée N° de FAX: **OK**  
 0123456789 █  
 [ Chaînes ] [ Détails ]

HU

FAX szám megad.:

[ Lánc ] [ Részl. ]

IT

N. voce FAX:

[ Catena ] [ Dettagli ]

NL

Faxnr. invoeren:

[ Keten ] [ Details ]

NO

Faksnummer:

[ Kjede ] [ Detaljer ]

PL

Wpis nr FAKSU:

[ Łańcuch ] [ Szczegóły ]

PT-BR

Entrada n° FAX:

[ Cadeia ] [ Detalhe ]

PT-PT

Entrada N° FAX:

[ Cadeia ] [ Detalhe ]

RO

Introd. nr. FAX:

[ În Lanț ] [ Detaliu ]

RU

Ввод № факса:

[ Цепь ] [ Сведения ]

SV

Ange faxnummer:

[ Kedja ] [ Uppgift ]

TR

FAKS No Girişi:

[ Zincir ] [ Ayrıntı ]

AR

إدخال رقم الفاكس:

[ التسلسل ] [ التفاصيل ]

4

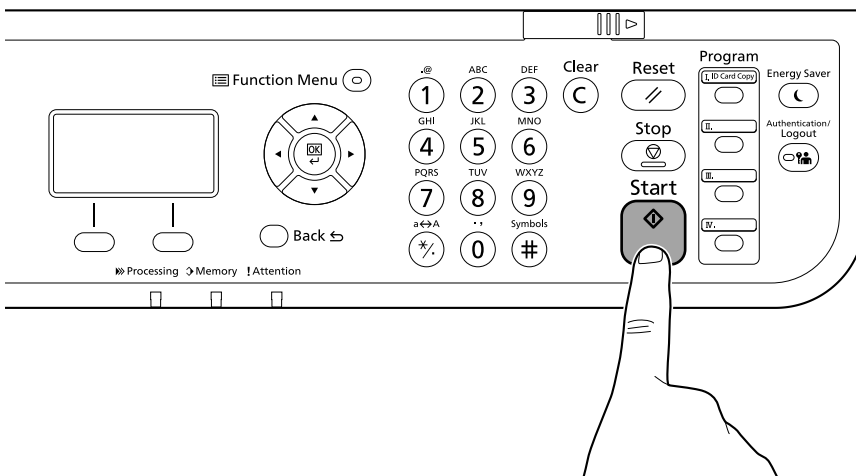

## From a PC

①

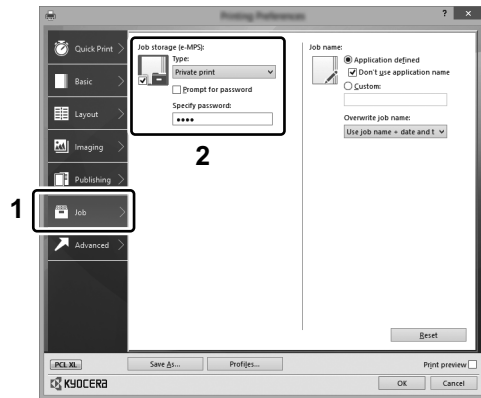

- ① EN To activate the private printing from the PC, set the items No. 1 and 2 in the screen.
- ② CA Per activar la impressió privada des d'un PC, configureu els elements núm. 1 i núm. 2 de la pantalla.
- ③ CS Pro aktivaci soukromého tisku z počítače vyberte položku č.1 a 2 na obrazovce.
- ④ DA For at aktivere privat udskrivning fra pc'en, indstilles enheder nr. 1 og 2 på skærmen.
- ⑤ DE Um den privaten Druck vom PC aus zu aktivieren, stellen Sie die Punkte 1 und 2 am Bildschirm ein.
- ⑥ EL Για να ενεργοποιήσετε την ιδιωτική εκτύπωση από τον υπολογιστή, ορίστε τα στοιχεία Αρ. 1 και 2 στην οθόνη.
- ⑦ ES Para activar la impresión privada desde el PC, configure los elementos número 1 y 2 en la pantalla.
- ⑧ FI Aktivoidaksesi yksityisen tulostuksen PC:ltä, aseta tiedot nro 1 ja 2 ruudulla.
- ⑨ FR Pour activer l'impression privée à partir de l'ordinateur, définir les éléments 1 et 2 sur l'écran.
- ⑩ HU A magán nyomtatás számítógépről történő aktiváláshoz a képernyőn állítsa be az 1. és a 2. tételt.
- ⑪ IT Per attivare la stampa privata da PC, configurare le voci N. 1 e N. 2 sulla schermata.
- ⑫ NL Om privé afdrucken vanaf de pc te activeren, stel de items nummer 1 en 2 op het scherm in.
- ⑬ NO For å aktivere privat utskrift fra PC, sett element nr. 1 og 2 på skjermen.
- ⑭ PL Aby aktywować drukowanie prywatne z poziomu komputera, skonfiguruj ustawienia oznaczone cyframi 1 i 2 na tym ekranie.
- ⑮ PT-BR Para ativar a impressão privada no PC, defina os itens N. 1 e 2 na tela.
- ⑯ PT-PT Para activar a impressão privada no PC, configure os itens n.º 1 e 2 no ecrã.
- ⑰ RO Pentru a activa imprimarea privată de la PC, setați elementele 1 și 2 de pe ecran.
- ⑱ RU Для активации конфиденциальной печати с ПК выполните настройку пунктов 1 и 2 на экране.
- ⑲ SV För att aktivera funktionen privat utskrift från PC:n, ställ in uppgifterna nr 1 och 2 på skärmen.
- ⑳ TR PC'den özel yazdırma işlemini aktive etmek için, ekranda madde No.1 ve 2'yi ayarlayın.
- ㉑ AR لتشغيل الطباعة الشخصية من جهاز الكمبيوتر، عين العنصرين رقم 1 و2 في الشاشة.

# From the Operation Panel

①

## ECOSYS M3645dn

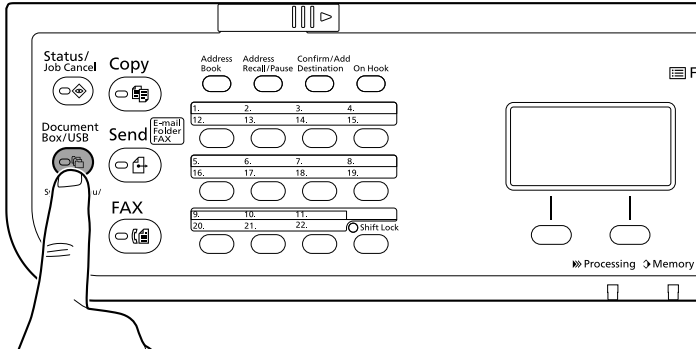

## ECOSYS M3145dn

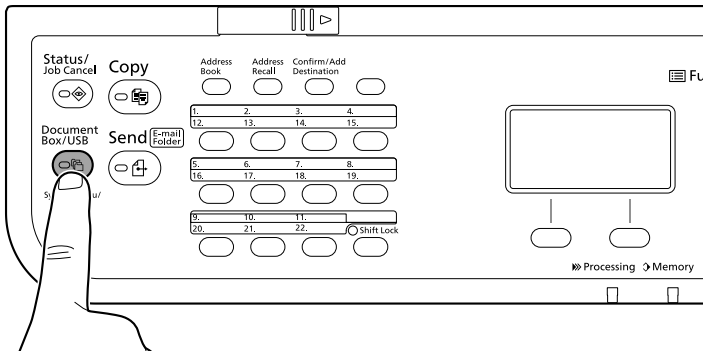

2

EN

Document Box:  OK  
 02 Sub Address Box  
 03 Polling Box  
 04 Job Box

Job Box:  OK  
 01 Private  
 Quick Copy

Private:  OK  
 User 01  
 User 02  
 User 03

User 01:  OK  
 Data 01   
 Data 02   
 Data 03   
 Menu Select

User 01:  OK  
 01 Print  
 Delete

Copies:  OK  
 (1 - 999 ---)  
 --- copies

Yes No

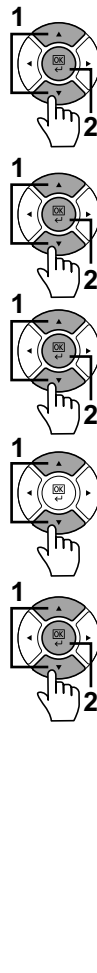

CA

Casella de docs.:  OK  
 02 Casella subadr.  
 03 Casella Polling  
 04 Casella treball

Casella treball:  OK  
 01 Privat  
 Copia rapida

Privat:  OK  
 User 01  
 User 02  
 User 03

User 01:  OK  
 Data 01   
 Data 02   
 Data 03   
 Menú Selec.

User 01:  OK  
 01 Imprimeix  
 Esborja

Còpies:  OK  
 (1 - 999)  
 --- còpies

Si No

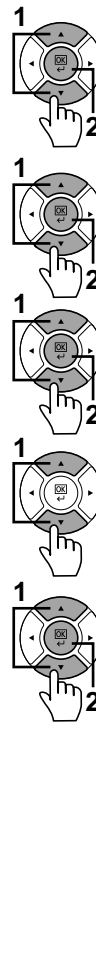

CS

Schr dokumentů:  OK  
 02 Pole Podadresa  
 03 Schr na dat  
 04 Schránka úlohy

Schránka úlohy:  OK  
 01 Soukromý tisk  
 Rychl. kopírování

Soukromý tisk:  OK  
 User 01  
 User 02  
 User 03

User 01:  OK  
 Data 01   
 Data 02   
 Data 03   
 Nabídka Vybrat

User 01:  OK  
 01 Tisk  
 Odstranit

Počet kopií:  OK  
 (1 - 999 ---)  
 --- kopie

Ano Ne

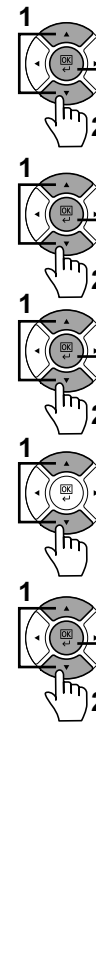

DA

Dokumentboks:  OK  
 02 Underadresseboks  
 03 Pollingboks  
 04 Jobboks

Jobboks:  OK  
 01 Privat udskrift  
 Hurtig kopi

Privat udskrift:  OK  
 User 01  
 User 02  
 User 03

User 01:  OK  
 Data 01   
 Data 02   
 Data 03   
 Menu Vælg

User 01:  OK  
 01 Udskriv  
 Slet

Kopier:  OK  
 (1 - 999 ---)  
 --- kopier

Ja Nej

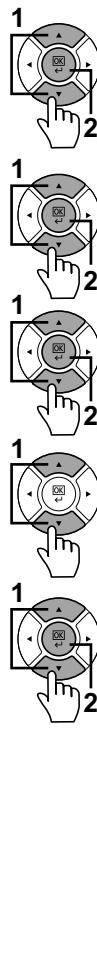

DE

Dokumentenbox:  OK  
 02 Eigene Faxbox  
 03 Abrufbox  
 04 Auftragsbox

Auftragsbox:  OK  
 01 Privater Druck  
 Schneidkopie

Privater Druck:  OK  
 User 01  
 User 02  
 User 03

User 01:  OK  
 Data 01   
 Data 02   
 Data 03   
 Menü Wählen

User 01:  OK  
 01 Drucken  
 Löschen

Kopien:  OK  
 (1 - 999 ---)  
 --- Kopien

Ja Nein

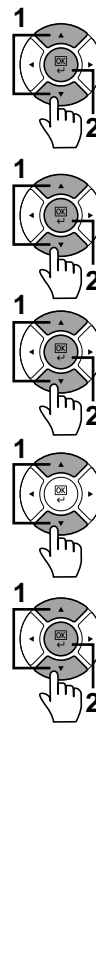

EL

Θυρίδα Εγγράφου:  OK  
 02 Πλαίσιο Υποδιεύ.  
 03 Θυρίδα Διαλογής  
 04 Θυρίδα εργασίας

Θυρίδα εργασίας:  OK  
 01 Ιδιωτική Εκτύπ.  
 Γρήγορη Αντίγραφο

Ιδιωτική Εκτύπ.:  OK  
 User 01  
 User 02  
 User 03

User 01:  OK  
 Data 01   
 Data 02   
 Data 03   
 Μενού Επιλογή

User 01:  OK  
 01 Εκτύπωση  
 Διαγραφή

Αντίγραφο:  OK  
 (1 - 999 ---)  
 --- αντίγ.

Ναι Όχι

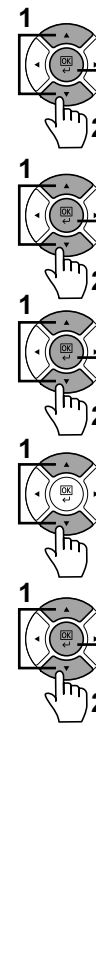



**ES**

Buzón doc.:  OK  
 02 Buzón subdirecc.  
 03 Buzón sandeo  
 04 Buzón trabajos

Buzón trabajos:  OK  
 01 Impres. privada  
 Copia rápida

Impres. privada:  OK  
 User 01  
 User 02  
 User 03

User 01:  OK  
 Data 01   
 Data 02   
 Data 03   
 Menú Seleccionar

User 01:  OK  
 01 Imprimir  
 Eliminar

Copias:  OK  
 (1 - 999 ---)  
 --- copias

Si No

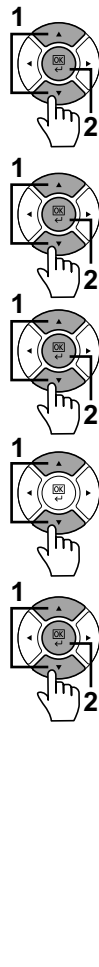

**FI**

Dokumenttilokero:  OK  
 02 Aliosoitelaat.  
 03 Kucelulaatikko  
 04 Työlaatikko

Työlaatikko:  OK  
 01 Yksityin. tulost  
 Pikakopio

Yksityin. tulost:  OK  
 User 01  
 User 02  
 User 03

User 01:  OK  
 Data 01   
 Data 02   
 Data 03   
 Valikko Valitse

User 01:  OK  
 01 Tulosta  
 Poista

Kopiot:  OK  
 (1 - 999 ---)  
 --- kopioi

Kyllä Ei

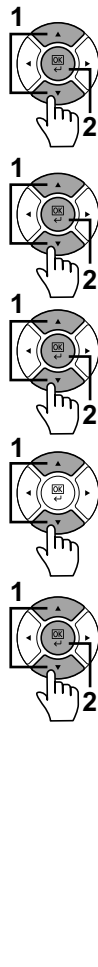

**FR**

Bte de documents:  OK  
 02 Boîte ss-adresse  
 03 Boîte Balling  
 04 Boîte travaux

Boîte travaux:  OK  
 01 Impr. privée  
 Copie rapide

Impr. privée:  OK  
 User 01  
 User 02  
 User 03

User 01:  OK  
 Data 01   
 Data 02   
 Data 03   
 Menu Sélectionner

User 01:  OK  
 01 Imprimer  
 Supprimer

Copies:  OK  
 (1 - 999 ---)  
 --- copies

Oui Non

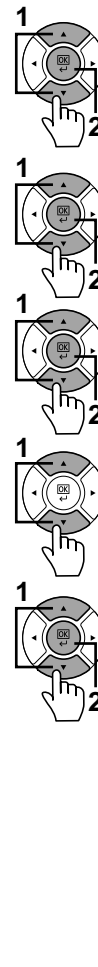

**HU**

Dokumentumfiók:  OK  
 02 Mellékazon. fiók  
 03 Levélár. fiók  
 04 Feladat fiók

Feladat fiók:  OK  
 01 Saját nyomtatás  
 Gyorsmásolás

Saját nyomtatás:  OK  
 User 01  
 User 02  
 User 03

User 01:  OK  
 Data 01   
 Data 02   
 Data 03   
 Menü Kiválasztás

User 01:  OK  
 01 Nyomtatás  
 Elimina

Példányszám:  OK  
 (1 - 999 ---)  
 --- péld.

Igen Nem

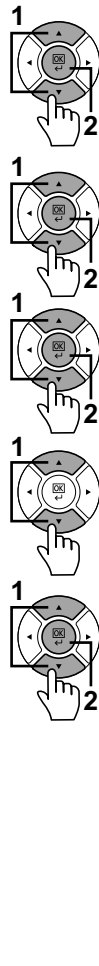

**IT**

Cas. documenti:  OK  
 02 Box SubAddress  
 03 Casella mailing  
 04 Casella lavoro

Casella lavoro:  OK  
 01 Stampa privata  
 Copia veloce

Stampa privata:  OK  
 User 01  
 User 02  
 User 03

User 01:  OK  
 Data 01   
 Data 02   
 Data 03   
 Menu Selez.

User 01:  OK  
 01 Stampa  
 Elimina

Copie:  OK  
 (1 - 999 ---)  
 --- copie

Si No

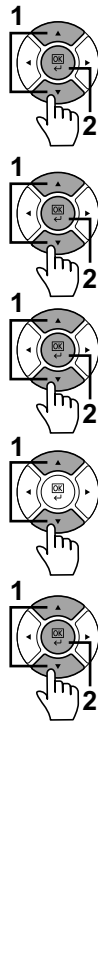

**NL**

Documentbox:  OK  
 02 Vak Subadres  
 03 Balling box  
 04 Taakvenster

Taakvenster:  OK  
 01 Privé-afdruk  
 Snelie kopie

Privé-afdruk:  OK  
 User 01  
 User 02  
 User 03

User 01:  OK  
 Data 01   
 Data 02   
 Data 03   
 Menu Kies

User 01:  OK  
 01 Afdrukken  
 Verwijderen

Print. Weet u het zeker?  
 - Data 01

Ja Nee

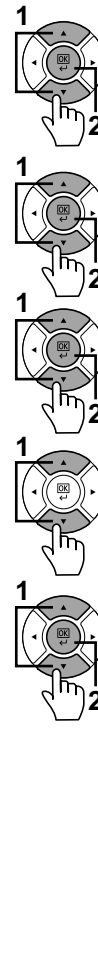

**NO**

Dokumentboks:  OK  
 02 Underdr. boks  
 03 Ballingboks  
 04 Boks

Boks:  
 01 Privat utskrift  
 02 Hurtigkopi

Privat utskrift:  OK  
 User 01  
 User 02  
 User 03

User 01:  
 Data 01   
 Data 02   
 Data 03   
 Meny Velg

User 01:  
 01 Skriv ut  
 02 Siett

Eksemplarer:  
 (1 - 999 ---)  
 --- ksemp

Ja Nei

**PL**

Skrzynka dok.:  OK  
 02 Skrz. adr. pom.  
 03 Skrz. adnut  
 04 Okno zadań.

Okno zadań:  
 01 Druk prywatny  
 02 Szybka kopia

Druk prywatny:  OK  
 User 01  
 User 02  
 User 03

User 01:  
 Data 01   
 Data 02   
 Data 03   
 Menu Wybierz

User 01:  
 01 Drukuj  
 02 usun

Kopie:  
 (1 - 999 ---)  
 --- kopie

Tak Nie

**PT-BR**

Caixa docs.:  OK  
 02 Caixa sub-ender.  
 03 Caixa caleta  
 04 Caixa trabalho

Caixa trabalho:  
 01 Impress. privada  
 02 Cópia rápida

Impress. privada:  OK  
 User 01  
 User 02  
 User 03

User 01:  
 Data 01   
 Data 02   
 Data 03   
 Menu Selec.

User 01:  
 01 Imprimir  
 02 Excluir

Cópias:  
 (1 - 999 ---)  
 --- cópias

Sim Não

**PT-PT**

Caixa Doc.:  OK  
 02 Caixa de subend.  
 03 Caixa mailing  
 04 Caixa de Trabs.

Caixa de Trabs.:  
 01 Impress. privada  
 02 Cópia rápida

Impress. privada:  OK  
 User 01  
 User 02  
 User 03

User 01:  
 Data 01   
 Data 02   
 Data 03   
 Menu Selecc.

User 01:  
 01 Imprimir  
 02 Eliminar

Cópias:  
 (1 - 999 ---)  
 --- cópias

Sim Não

**RO**

Casetă Document:  OK  
 02 Casetă subadresă  
 03 Casetă Interog  
 04 Casetă lucrare

Casetă lucrare:  
 01 Imprim. privată  
 02 Copie rapidă

Imprim. privată:  OK  
 User 01  
 User 02  
 User 03

User 01:  
 Data 01   
 Data 02   
 Data 03   
 Menu Select.

User 01:  
 01 Imprimare  
 02 ștergere

Copii:  
 (1 - 999 ---)  
 --- copii

Da Nu

**RU**

Ящик докум.:  OK  
 02 Ящик доп. адреса  
 03 Ящик опроса  
 04 Поле заданий

Поле заданий:  
 01 Конфиден. печать  
 02 Быстрая копия

Конфиден. печать:  OK  
 User 01  
 User 02  
 User 03

User 01:  
 Data 01   
 Data 02   
 Data 03   
 Меню Выбрать

User 01:  
 01 Печать  
 02 Удалить

Копии:  
 (1 - 999 ---)  
 --- копий

Да Нет

SV

dokumentlåda:  OK

02 Subadressbox

03 Rollningelåda

04 Jobblåda

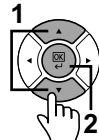

Jobblåda:

01 Privat utskrift

Snabbkopia

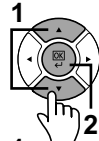

Privat utskrift:  OK

User 01

User 02

User 03

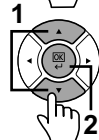

User 01:

Data 01

Data 02

Data 03

Meny Välj

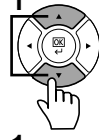

User 01:

01 Skriv ut

Kamera

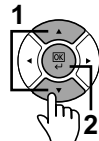

Kopior:  OK

(1 - aaa ---)

--- kopior

Ja Nej



TR

Belge Kutusu:  OK

02 Alt Adres Kutusu

03 Çağırma Kutusu

04 İş Kutusu

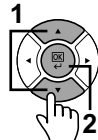

İş Kutusu:

01 Özel Yazdır

Hızlı kopya

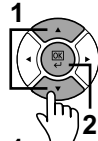

Özel Yazdır:  OK

User 01

User 02

User 03

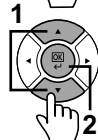

User 01:

Data 01

Data 02

Data 03

Menü Seç

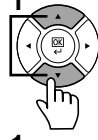

User 01:

01 Yazdır

Sil

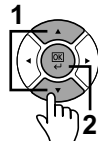

Kopyalar:  OK

(1 - aaa ---)

--- kopya

Evet Hayır



AR

صندوق المستند:  OK

02 ص. عنوان فرعي

03 ص. نسخة استقدام

04 صندوق المهام

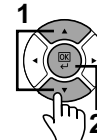

ص. نسخة استقدام:

01 مهمة طباعة

نسخ سريع

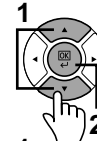

مهمة طباعة:  OK

User 01

User 02

User 03

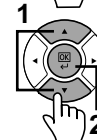

User: 01:

Data 01

Data 02

Data 03

قائمة حدد

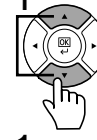

User: 01:

01 طباعة

حذف

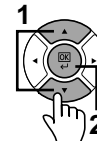

النسخ:  OK

(1 - aaa ---)

--- نسخ

نعم لا



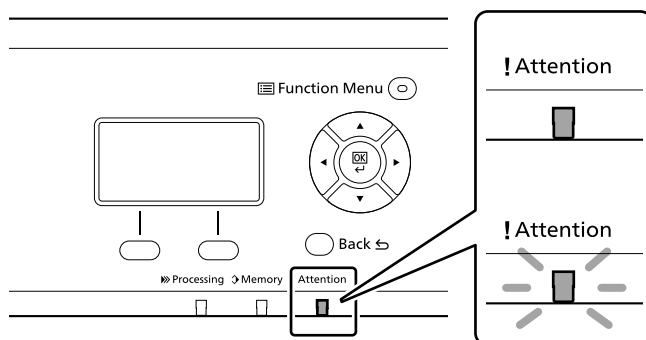

- EN** If an error occurs on the machine, the error message appears on the screen. Also the Attention indicator on the operation panel will light up or flash. Refer to the Operation Guide to Clear the error. For details, refer to the Operation Guide on the Product Library disc.
- CA** Si es produeix un error en el dispositiu, es mostrarà el missatge d'error a la pantalla. També s'il·luminarà o parpellejarà l'indicador "Attention" (Alerta) al tauler d'operacions. Consulteu la Guia de funcionament per esborrar l'error. Per obtenir més informació, consulteu la Manual d'instruccions al disc Biblioteca del producte.
- CS** Pokud v zařízení dojde k chybě, na obrazovce se objeví chybové hlášení. Indikátor Attention na ovládacím panelu se rozsvítí nebo bude blikat. Pro odstranění chyby se řiďte návodem k obsluze na disku Product Library.
- DA** Hvis der opstår fejl på maskinen, vises fejlmeddelelsen på skærmen. Samtidig vil Attention-lampen på betjeningspanelet lyse eller blinke. Se betjeningsguiden for at slette fejlen. Se Betjeningsvejledning på Product Library disken for yderligere information.
- DE** Falls ein Gerätefehler auftritt, erscheint eine Fehlermeldung in der Anzeige. Außerdem leuchtet oder blinkt die LED "Warnung" auf dem Bedienfeld. Lesen Sie in der Bedienungsanleitung nach, um den Fehler zu beseitigen. Weitere Details finden Sie in der Bedienungsanleitung auf dem Product Library Datenträger.
- EL** Αν πραγματοποιηθεί σφάλμα στο μηχάνημα, το μήνυμα του σφάλματος εμφανίζεται στην οθόνη. Επίσης, η ενδεικτική λυχνία Attention στον Πίνακα Λειτουργίας θα ανάψει ή θα αναβοσβήσει. Ανατρέξτε στο Εγχειρίδιο Χρήσης για να διορθώσετε το σφάλμα. Για λεπτομέρειες, ανατρέξτε στο Εγχειρίδιο Χρήσης στον δίσκο Product Library.
- ES** Si se produce un error en la máquina, el mensaje de error aparecerá en la pantalla. Además, el indicador Atención del panel de controles se iluminará o parpadeará. Consulte la Guía de uso para borrar el error. Para obtener más información, consulte la Guía de uso que está disponible en el disco Product Library.
- FI** Jos koneessa on vikatila, ruudulle ilmestyy vikailmoitus. Myös toimintapaneelin Attention -indikaattori syttyy tai vilkkuu. Katso Toimintaoppaasta, kuinka vikatila poistetaan. Löydät yksityiskohtaiset tiedot Tuotekirjastolevyn Käyttöopas.
- FR** Si une erreur se produit sur la machine, le message d'erreur s'affiche sur l'écran. De plus, le voyant Attention s'allume ou clignote sur le panneau de commande. Se reporter au manuel d'utilisation pour effacer l'erreur. Pour plus de détails, se reporter au manuel d'utilisation sur le disque Product Library.
- HU** Ha hiba történik a készüléken, egy hibaüzenet jelenik meg a képernyőn. Emellett az Attention jelzőfény is világít vagy villog a kezelőpanelen. A hiba megszüntetéséhez lásd a használati útmutatót. Részletekért lásd a Product Library lemezen lévő Használati útmutatót.
- IT** Se sulla macchina si verifica un errore, sullo schermo viene visualizzato un messaggio di errore. Inoltre, l'indicatore Attenzione del pannello comandi si illumina oppure lampeggia. Per eliminare l'errore, consultare la Guida alle funzioni. Per i dettagli, vedere la Guida alle funzioni, reperibile sul disco Product Library.
- NL** Als er een fout optreedt op het apparaat, dan verschijnt de foutmelding op het scherm. Bovendien gaat ook het Opgelet-indicatorlampje op het bedieningspaneel branden of knipperen. Raadpleeg de Gebruikershandleiding om de fout te wissen. Voor meer informatie, raadpleeg de Gebruikershandleiding op de Product Library schijf.

- NO** Hvis det oppstår en feil på maskinen, vises feilmeldingen på skjermen. Også "Attention"-indikatoren på betjeningspanelet vil tennes eller begynne å blinke. Se brukerveiledningen for å fjerne feilen. For detaljer, se Operatørhåndbok i produktbiblioteket.
- PL** Jeżeli na urządzeniu wystąpi błąd, na wyświetlaczu zostanie wyświetlony komunikat o błędzie. Błąd jest sygnalizowany też zaświeceniem się lub miganie wskaźnika Attention na panelu operacyjnym. Aby skasować błąd, postępuj zgodnie z instrukcją obsługi. Więcej informacji można znaleźć w Podręcznik obsługi znajdującej się na dysku Product Library.
- PT-BR** Se ocorrer um erro na máquina, a mensagem de erro aparece na tela. Também o indicador Atenção no painel de operação vai acender ou piscar. Consulte o Guia de Operação para corrigir o erro. Para obter detalhes, consulte o Guia de Operação no disco Biblioteca do Produto.
- PT-PT** Se ocorrer um erro na máquina, a mensagem de erro surge no ecrã. Além disso, o indicador "Atenção" no painel de operações irá acender ou piscar. Consulte o Guia de Funcionamento para Limpar o erro. Para mais informações consulte o Guia de Uso no disco da Biblioteca de Produtos.
- RO** Dacă apare eroare la aparat, mesajul de eroare apare pe ecran. De asemenea, indicatorul Attention de pe panoul de operare se va lumina sau va clipi. Consultați Ghidul de Operare pentru a rezolva eroarea. Pentru detalii, consultați Ghid de operare de pe discul Product Library.
- RU** Если в работе аппарата произошла ошибка, на экране появится сообщение об ошибке. Также будет светиться или мигать индикатор Внимание на панели управления. По поводу сброса ошибки см. руководство по эксплуатации. Дополнительная информация приведена в Руководстве по эксплуатации на диске Product Library.
- SV** Om ett fel uppstår på maskinen, visas felmeddelandet på skärmen. Även "Attention"-indikatorn på kontrollpanelen tänds eller blinkar. Hänvisning ges till användarmanualen för information om hur man tar bort felet. För ytterligare detaljer, konsultera Bruksanvisning som finns på skivan Product Library.
- TR** Makinede bir hata meydana gelirse, hata mesajı ekranda görüntülenir. Ayrıca çalıştırma panelindeki Attention göstergesi yanıp söner veya yanık kalır. Hatayı temizlemek için Çalıştırma Kılavuzuna bakın. Ayrıntılar için, Product Library DVD'sindeki Çalıştırma Kılavuzuna bakınız.
- AR** في حالة حدوث خطأ في الجهاز، تظهر رسالة الخطأ على الشاشة، وكذلك يضيء مؤشر Attention على لوحة التشغيل أو يومض. راجع دليل التشغيل للتخلص من الخطأ. للحصول على تفاصيل، راجع دليل التشغيل على قرص Product Library.

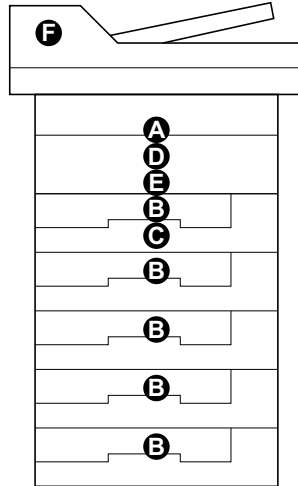
**A**

①

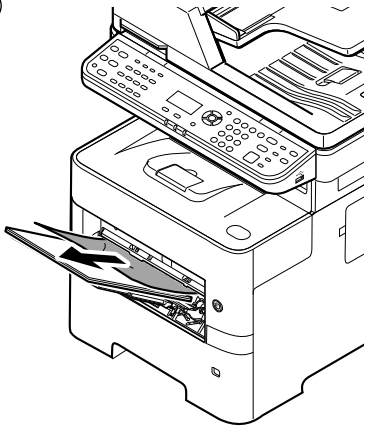

②

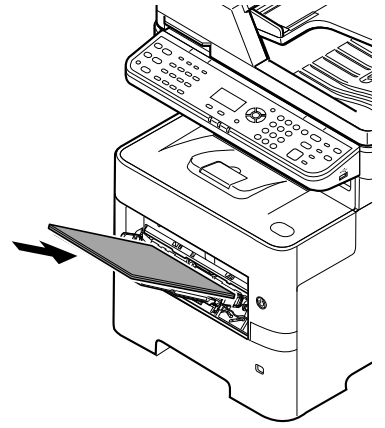
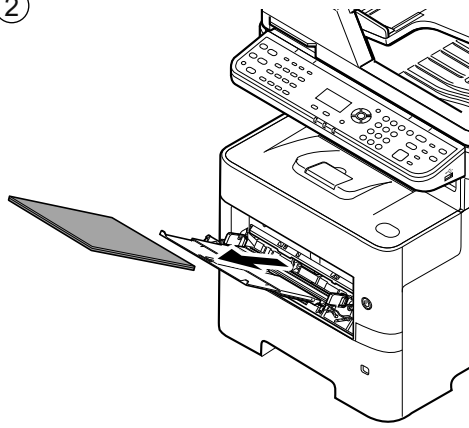
**B**

①

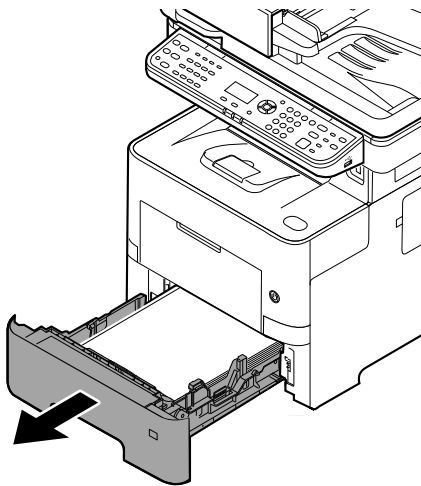

②

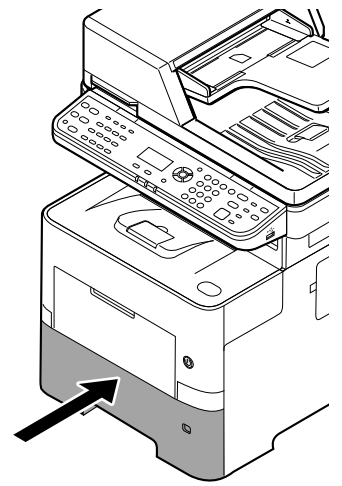
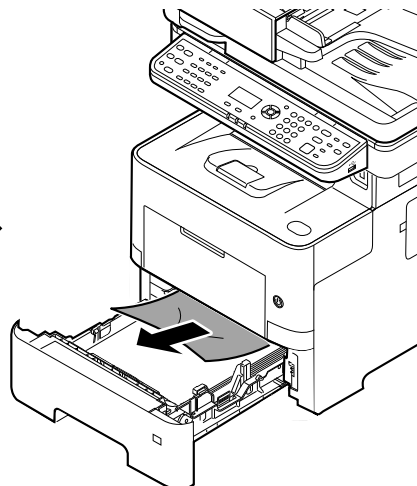

PF-3110

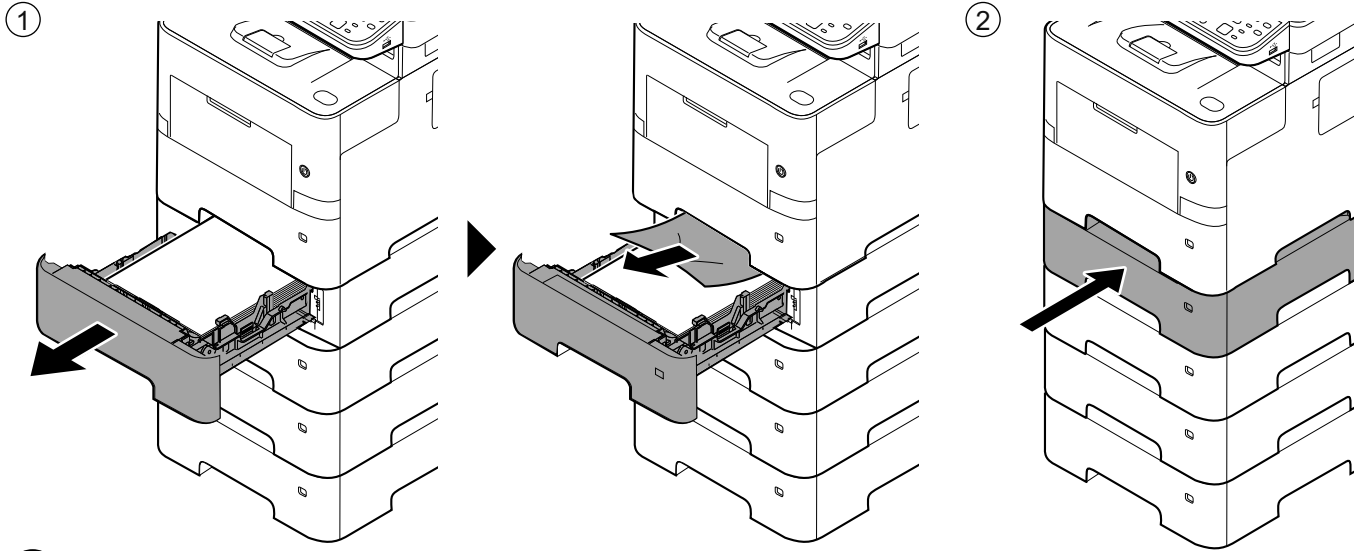

**C**

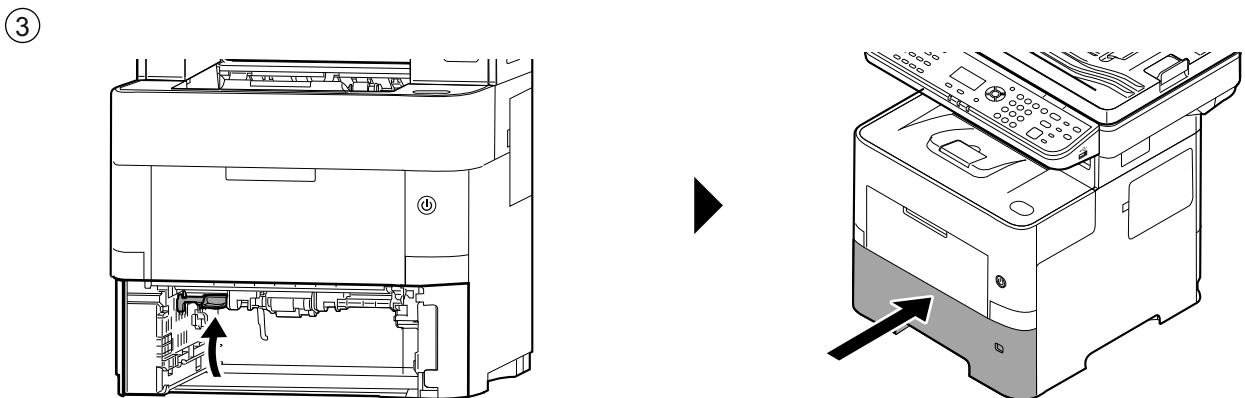
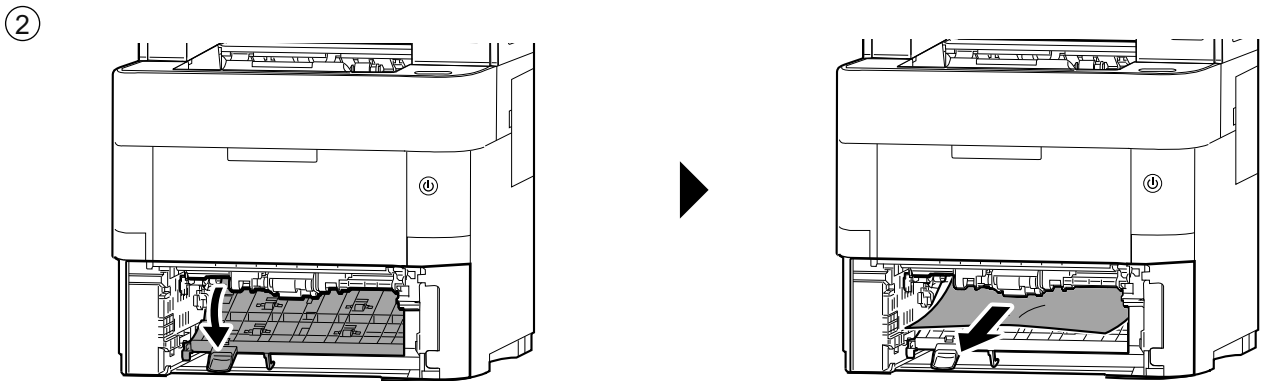
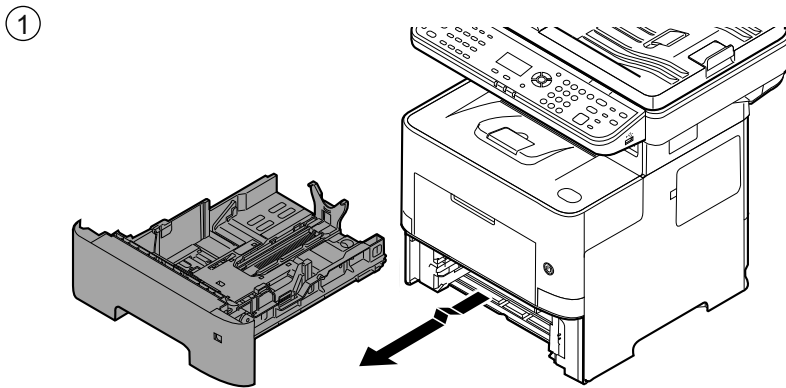

**D**

①

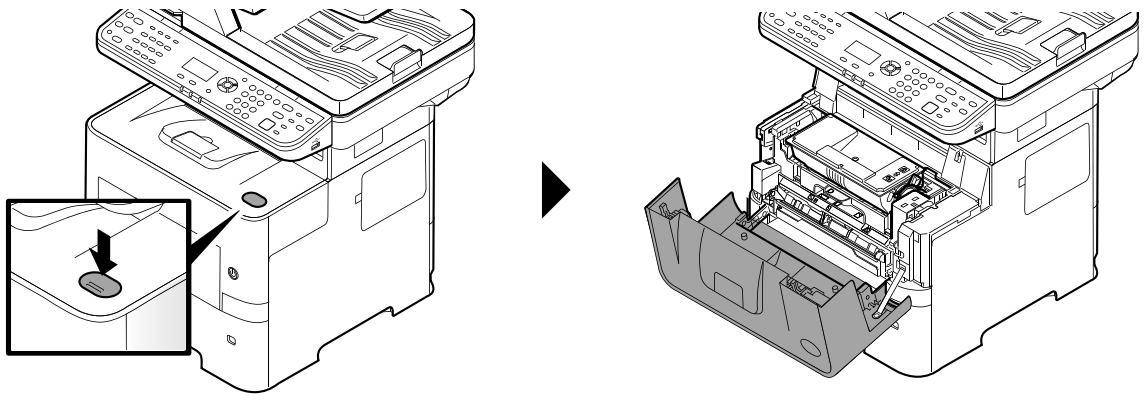

②

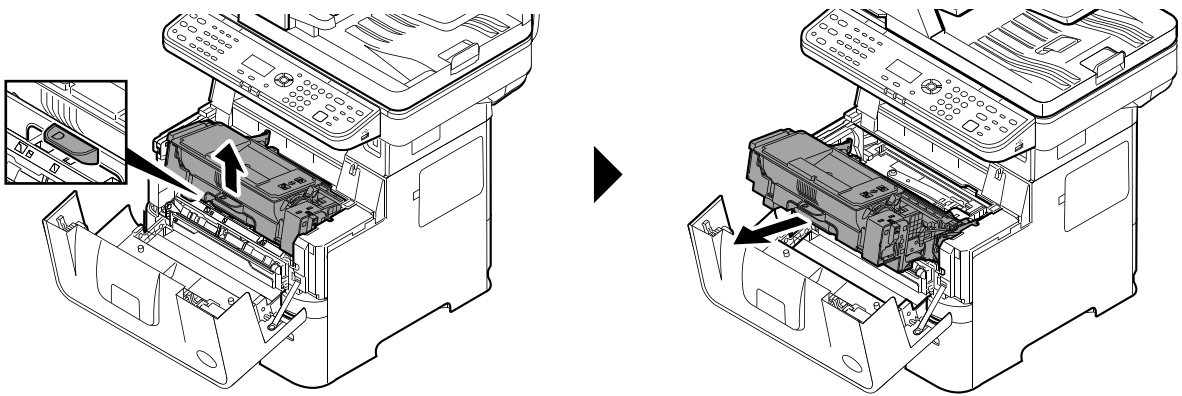

③

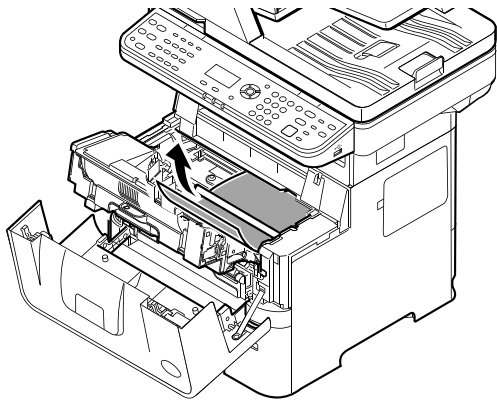

④

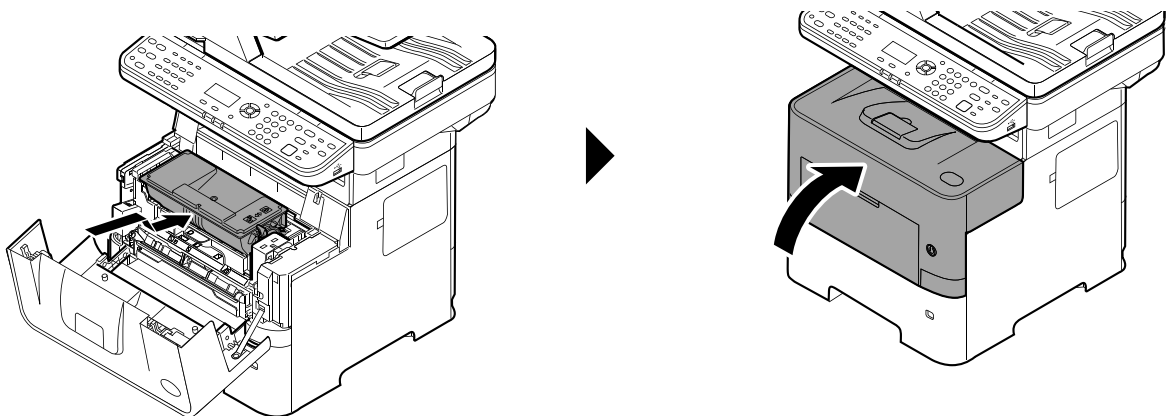



**E**

①

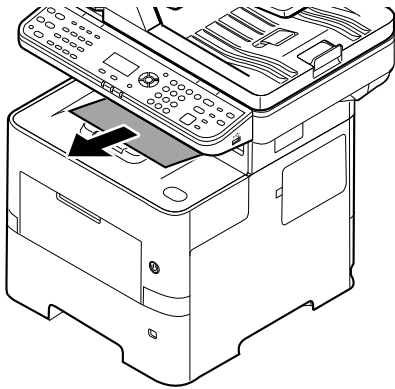

②

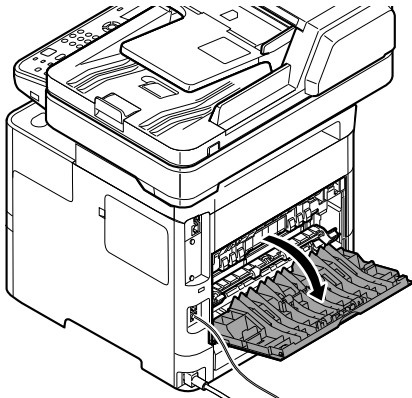

③

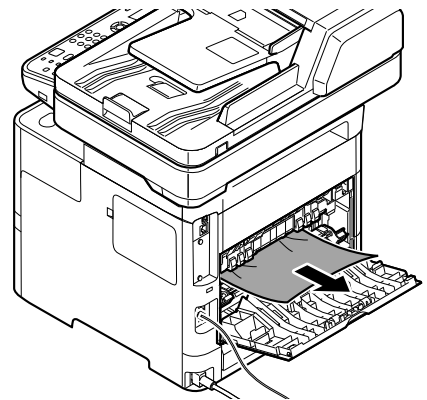
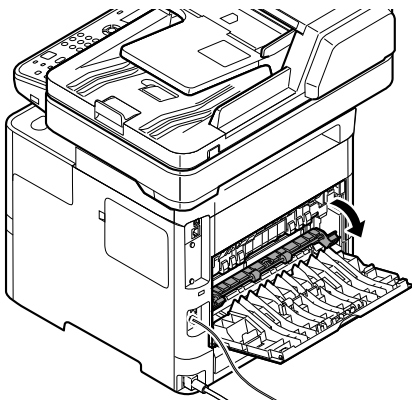

④

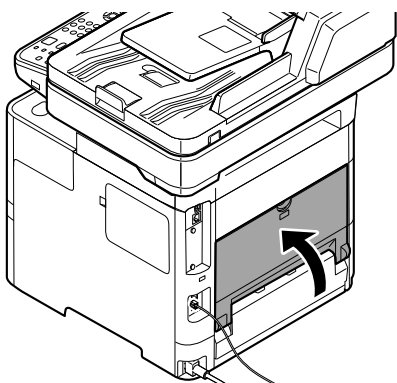

**F**

①

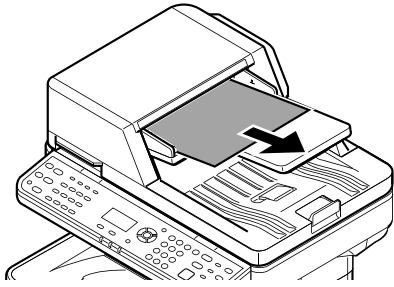

②

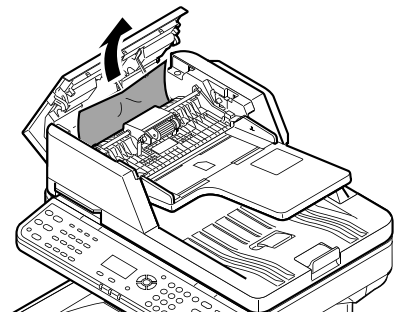
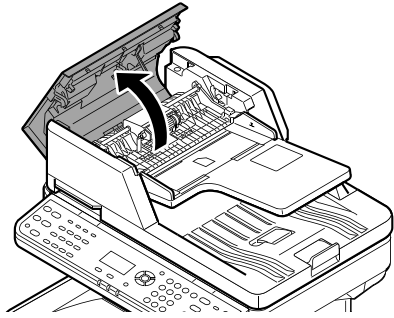

③

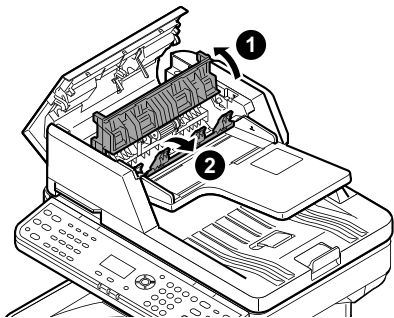

④

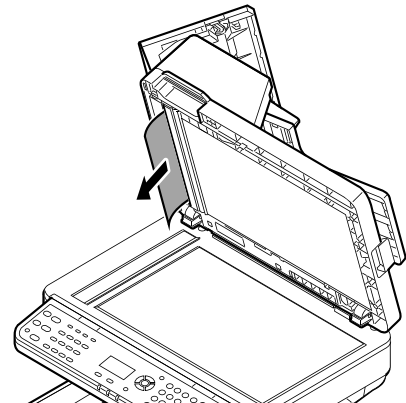
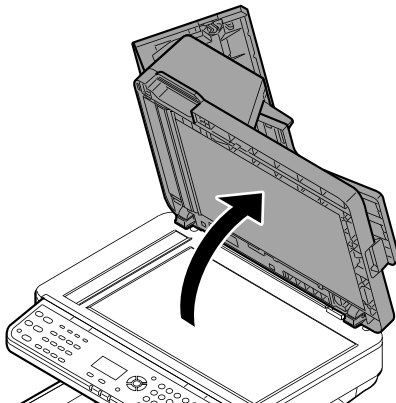

⑤

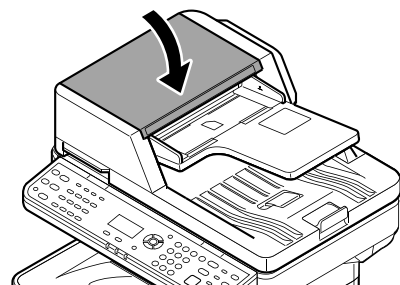
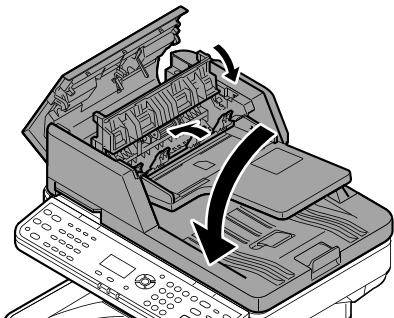



**QUALITY  
CERTIFICATE**

This machine has passed  
all quality controls and  
final inspection.

