

User's Manual



Video Wall Ultra 4K HDMI/USB Extender over IP with PoE

▶ IHD-410PT / IHD-410PR



Copyright

Copyright (C) 2017 PLANET Technology Corp. All rights reserved.

The products and programs described in this User's Manual are licensed products of PLANET Technology. This User's Manual contains proprietary information protected by copyright, and this User's Manual and all accompanying hardware, software, and documentation are copyrighted.

No part of this User's Manual may be copied, photocopied, reproduced, translated, or reduced to any electronic medium or machine-readable form by any means, electronic or mechanical including photocopying, recording, or information storage and retrieval systems, for any purpose other than the purchaser's personal use, and without the prior express written permission of PLANET Technology.

Disclaimer

PLANET Technology does not warrant that the hardware will work properly in all environments and applications, and makes no warranty and representation, either implied or expressed, with respect to the quality, performance, merchantability, or fitness for a particular purpose.

PLANET has made every effort to ensure that this User's Manual is accurate; PLANET disclaims liability for any inaccuracies or omissions that may have occurred. Information in this User's Manual is subject to change without notice and does not represent a commitment on the part of PLANET. PLANET assumes no responsibility for any inaccuracies that may be contained in this User's Manual. PLANET makes no commitment to update or keep current the information in this User's Manual, and reserves the right to make improvements and/or changes to this User's Manual at any time without notice.

If you find information in this manual that is incorrect, misleading, or incomplete, we would appreciate your comments and suggestions.

FCC Compliance Statement

This Equipment has been tested and found to comply with the limits for a Class A digital device, pursuant to Part 15 of the FCC rules. These limits are designed to provide reasonable protection against harmful interference in a residential installation. This equipment can radiate radio frequency energy and, if not installed and used in accordance with the instructions, may cause harmful interference to radio communications.

However, there is no guarantee that interference will not occur in a particular installation. If this equipment does cause harmful interference to radio or television reception, which can be determined

by turning the equipment off and on, the user is encouraged to try to correct the interference by one or more of the following measures:

- Reorient or relocate the receiving antenna.
- Increase the separation between the equipment and receiver.
- Connect the equipment into an outlet on a circuit different from that to which the receiver is connected.
- Consult the dealer or an experienced radio/TV technician for help.

CE mark Warning



The is a class A device, In a domestic environment, this product may cause radio interference, in which case the user may be required to take adequate measures.

WEEE



To avoid the potential effects on the environment and human health as a result of the presence of hazardous substances in electrical and electronic equipment, end users of electrical and electronic equipment should understand the meaning of the crossed-out wheeled bin symbol. Do not dispose of WEEE as unsorted municipal waste and have to collect such WEEE separately.

Trademarks

The PLANET logo is a trademark of PLANET Technology. This documentation may refer to numerous hardware and software products by their trade names. In most, if not all cases, these designations are claimed as trademarks or registered trademarks by their respective companies.

Revision

User's Manual of PLANET High Definition HDMI Extender over IP with PoE

Model: IHD-410PT / IHD-410PR

Rev.: 1.0 (April, 2017)

Part No. EM-IHD-410 Series_v1.0

Table of Contents

Chapter 1. Product Introduction.....	6
1.1 Package Contents.....	6
1.2 Overview	7
1.3 Features	11
1.4 Product Specifications	12
1.5 Hardware Interface	14
1.5.1 Diagrams:.....	14
1.5.2 Interfaces:	15
1.6 Device Connection Topology	17
Chapter 2. Hardware Installation	19
2.1 Devices Requirements	19
2.2 Installation Instructions	19
Chapter 3. Preparation	20
3.1 Find the IP Address via Monitor.....	20
3.2 Find the IP Address via Bonjour Browser Software.....	21
3.3 Setting TCP/IP on your PC	22
3.3.1 Windows XP.....	22
3.3.2 Windows 7	25
3.3.3 Windows 10	28
Chapter 4. Web-based Management	31
4.1 System	32
4.1.1 Version Information.....	32
4.1.2 Update Firmware	32
4.1.3 Utilities	33
4.1.4 Statistics.....	34
4.2 Video Wall.....	35
4.2.1. Basic Setup.....	35
4.2.2. Setup Steps (Examples).....	39
4.2.3. Advanced Setup	41
4.3 Network.....	44
4.3.1. IP Setup	44
4.3.2. Casting Mode.....	44
4.4 Function	46
4.4.1. Video over IP	46
4.4.2. USB over IP	47

4.4.2. Serial over IP	48
APPENDIX A. Troubleshooting & Frequently Asked Questions	49

Chapter 1. Product Introduction

1.1 Package Contents

The package should contain the following:

- Media Extender x 1
- Quick Installation Guide x 1
- IR Emitter Cable with Transmitter x 1
- IR Receiver Cable with Receiver x 1
- Mounting Bracket x 2
- Screws x 4



Note

If any of the above items are missing, please contact your dealer immediately.

1.2 Overview

Ultra High-quality 4K HDMI Video Wall

PLANET IHD-410 HDMI/Video Wall over IP with PoE delivers a great 4K video distribution solution such as bringing an efficient and effective advertising deployment. The IHD-410 series is the combination of the transmitter, IHD-410PT, and the receiver, IHD-410PR. They can be used as an audio, video and IR extender over IP and applied to point to point, point to multi-point, multi-point to multi-point and eye-catching video walls of up to 16 by 8 displays.



IR Extension for Controlling Video Source

The IHD-410 series is a perfect solution for audio and video signal extension via the Gigabit LAN. Designed with IR transmitter and receiver interface, it allows users to control the video source at the terminal destination. The IHD-410 series features bi-directional IR extension and RS-232 pass-through which allows the user to cascade the system enabling them to extend the transmission distance without signal loss or delay. It also supports VGA Local Output function for checking video source conveniently.

They come with USB interfaces, which support basic KVM applications, such as touch screens, keyboards and mice, enabling users to achieve KVM PC control easily. Besides, with PoE function, there is no additional power supply needed, and the IHD-410 series thus reduces the complexity of cable installation.

Multiple HDMI and USB over IP Interaction Application

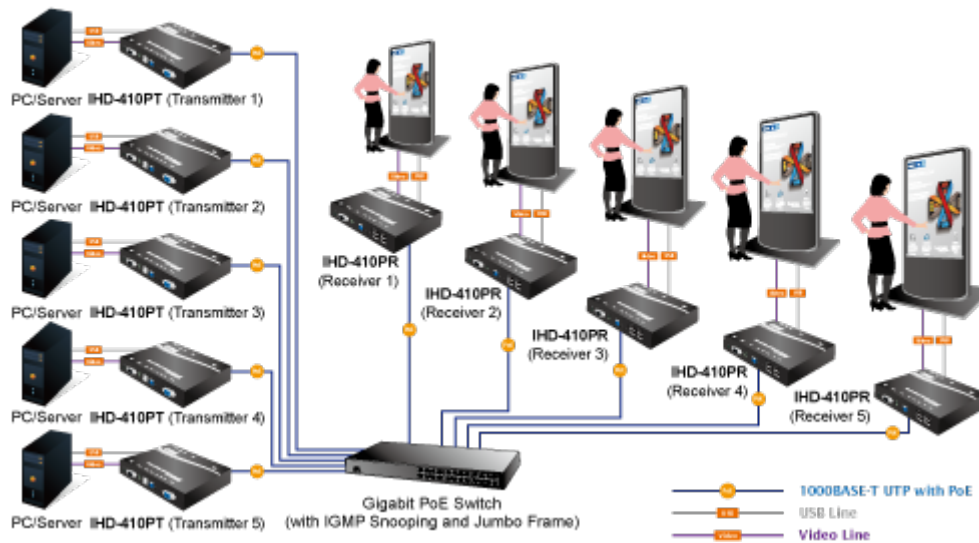

Exclusive Video Transmission by IGMP Snooping Technology

One IHD-410PT in local site can drive multiple IHD-410PRs in remote sites without consuming extra network loading. Integrated with PoE switch built-in with IGMP snooping function, there are 64 channels selectable via the IHD-410 series, so video and audio can be transmitted simultaneously. IGMP snooping is an integral part of IP multicast and a communications protocol used by hosts and adjacent routers on IP networks to establish multicast group memberships. IGMP snooping can be used for one-to-many/many-to-many networking applications such as online streaming video and gaming, and allows exclusive transmission and more efficient use of resources.

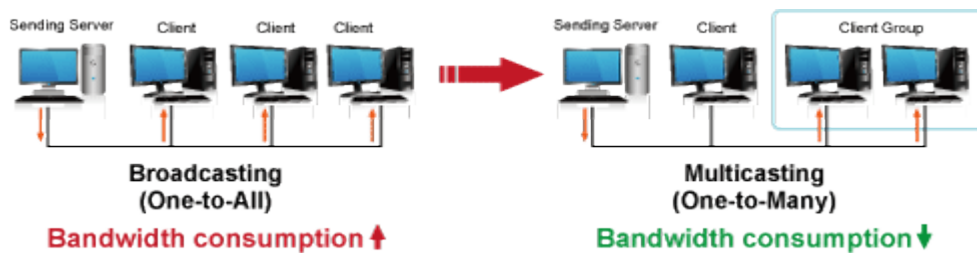

Extended Display Identification Data (EDID) Support

The IHD-410 series adopts Automatic EDID (Extended Display Identification Data) Copy function to make smooth video distribution over different types of display units. EDID is greatly important as it contains information about resources' manufacturer names, serial numbers, product types, maximum image sizes, color characteristics, factory pre-set timings, frequency range limits, etc. In some cases, display problems may occur due to incorrect EDID communication between the display monitor and the transmitting unit or inappropriate EDID data programmed by display manufacturers. Therefore,

with Automatic EDID Copy function, the IHD-410 series allows the system to copy EDID information from EDID compliant displays and assures accurate display performance.

Without Extended Display Identification Data

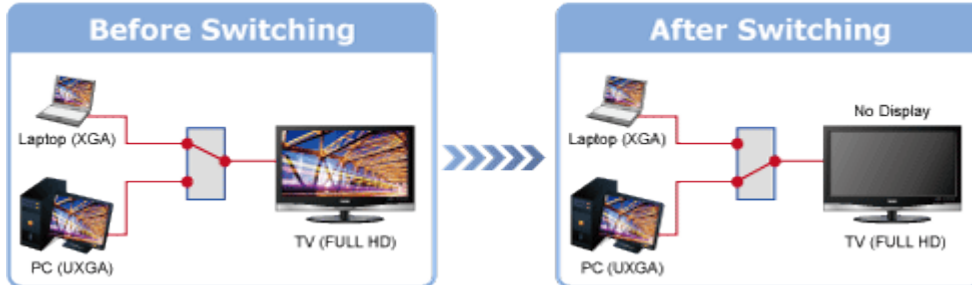

Supports Extended Display Identification Data

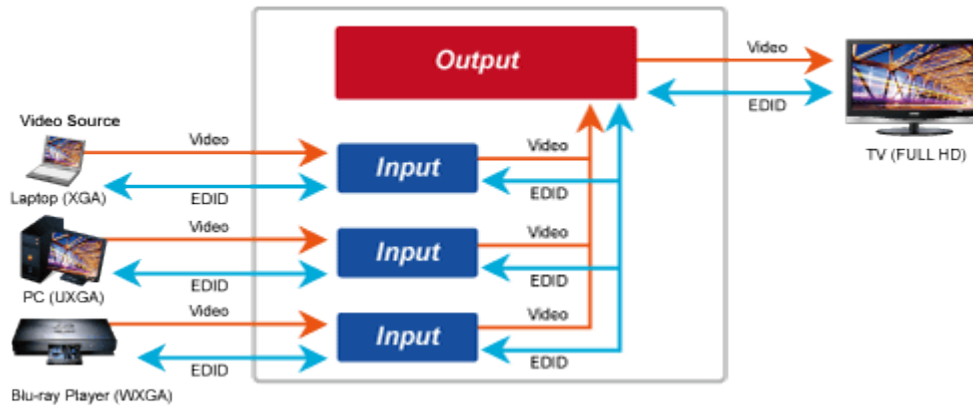

Video Channel Setting Matches Well through Network Configuration

The IHD-410 series network can be configured by a central computer over the same LAN within a certain distance. Fully leveraging the Gigabit Ethernet switches with 802.1Q VLAN function, multi-casting can be performed to allow more video sources/senders in the network and be remotely managed. Just adjust and match video channel setting with the simple DIP switch in both the IHD-410PT and IHD-410PR. The video distribution is easily deployed through Plug and Play.

Network Configuration

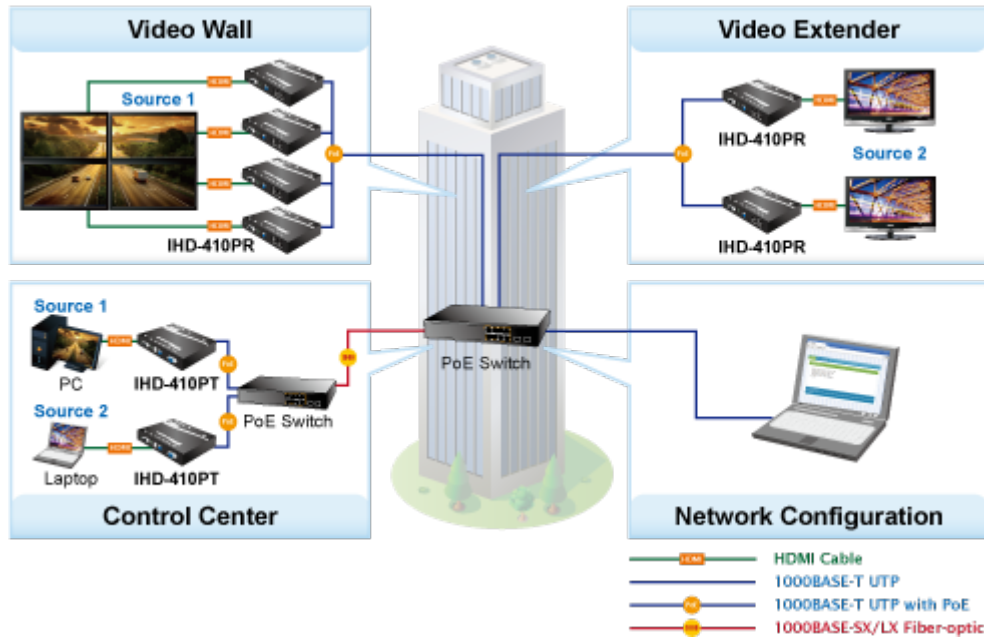

Efficient Control via Selectable 16-Channel DIP Switch

Where there is more than one transmitter in the video extend system, the DIP switch in the IHD-410PT and IHD-410PR facilitates distinguishing the pair of the transmitter and receiver units in the same channel. It further enables the broadcasting system to perform multiple video extend systems simultaneously through matching of the IHD-410PT and IHD-410PR.

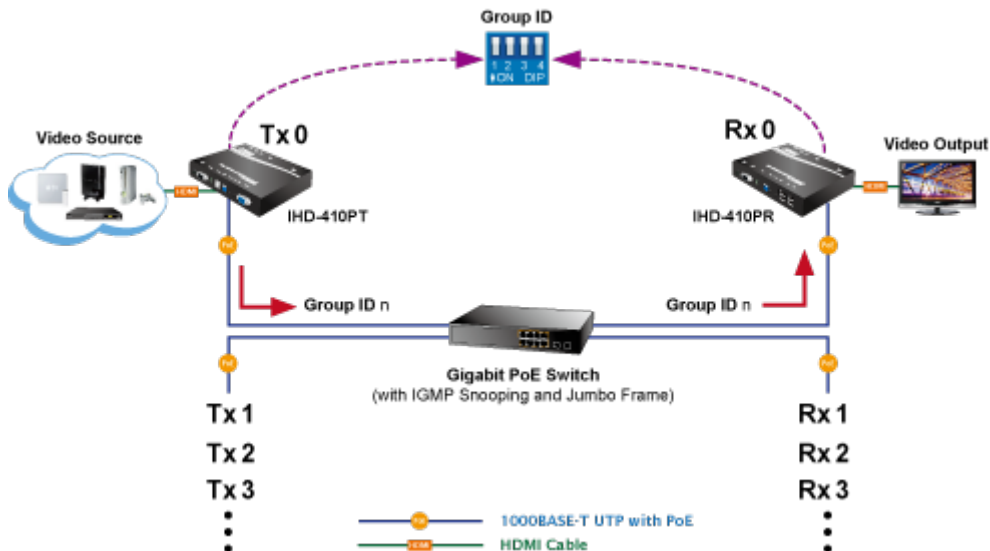

1.3 Features

➤ HDMI Network

- 4K ultra high-quality video transmitter
- Supports IR extension for controlling video source
- Supports RS-232 bi-directional remote extension
- Assigns video sources to any monitor of the video wall system
- The selectable 16-channel DIP switch is easily applied for multi-casting group matching
- 1-to-1,1-to-many and multi-casting broadcasting architectures allow to add more displays without increasing LAN bandwidth loading

➤ Video Output Characteristics

- Supports 1080p or 4K (3840 x 2160) HDMI resolution
- HDCP compliant and blu-ray ready
- Supports VGA local output
- Compatible with common screen resolutions from XGA, SXGA, UXGA, WSXGA and Full HD to the latest 4K system
- Output video rotation
- Supports HDMI with 2-ch. uncompressed audio or external audio in and out

➤ Easy Installation and Management

- Supports USB for KVM PC control
- IEEE 802.3af/at PoE+ function supported; no additional power supply needed
- Automatic EDID configuration
- Friendly Web UI for ease of use
- Supports multi-casting group with Gigabit Ethernet Managed Switch (IGMP snooping and jumbo frame functions required)

1.4 Product Specifications

Model	IHD-410PT	IHD-410PR
Hardware Specifications		
Network Interface	RJ45 port (10/100/1000BASE-T Ethernet) x 1	
Serial Interface	DB-9 female connector for RS232 x 1	
LED	ACT LED x 1 Link LED x 1	
Buttons	Reset button x 1 G/V mode button x 1	
Video In Interface	HDMI A Type female connector x 1	N/A
Video Out Interface	VGA DB-15 female connector x 1	HDMI A Type female connector x 1
External Audio In Interface	3.5mm jack x 1	
External Audio Out Interface	3.5mm jack x 1	
IR	3.5mm jack for IR emitter cable	3.5mm jack for IR receiver cable
Channel Switching	DIP (16 channels)	
USB	USB 2.0 type B x 1 (For PC/server)	USB 2.0 type A x 4 (For mouse/keyboard)
Power Supply	IEEE 802.3af/at PoE+ 12V DC, 2A	
Power Consumption	3W (Min.) 14W (Max.)	
Dimensions (W x D x H)	194 x 114 x 28 mm	
Weight	620 g	
Video and Audio		
Maximum Video Wall	8 x 16 (row x column)	
HDMI Video In Resolution	4K (3840 x 2160) @30/24 Hz 1080p @ 60/50 Hz 1080p @30/25 Hz 1080i @ 60/50 Hz 720p @ 60/50 Hz 480p @ 60/50 Hz 480i @ 60/50 Hz	N/A
HDMI Video Out Resolution	N/A	4K (3840 x 2160) @30/24 Hz 1080p @30/25 Hz 1080i @ 60/50 Hz 720p @ 60/50 Hz 480p @ 60/50 Hz 480i @ 60/50 Hz
VGA Video Out Resolution	1080p @30/25 Hz 1080i @ 60/50 Hz 720p @ 60/50 Hz 480p @ 60/50 Hz	N/A

Model	IHD-410PT	IHD-410PR
	480i @ 60/50 Hz	
HDMI Video Out Rotation	0 degrees/180 degrees/270 degrees	
Compression	Visual lossless compression	
Audio	HDMI: 2-ch uncompressed audio	
General		
Management Interfaces	Web management	
System Expandability (max.)	16 groups	
Resolution Identification	EDID	
Security	HDCP compliant	
Media Stream Bandwidth	Approximately 275Mbps @ 4K 30Hz	
Maximum Distance (between unit and PoE switch)	100 meters (330 feet) over Cat5e/6 cable	
Standards Conformance		
Standards Compliance	IEEE 802.3 10BASE-T IEEE 802.3u 100BASE-TX IEEE 802.3ab 1000BASE-T IEEE 802.3af/at PoE+	
HDMI Interface Compliance	HDMI 1.4a	
Protocol	TCP, UDP, RTSP, RTP, DHCP, IGMP Snooping, Multicast, IPv4	
Cabling	Cat5e/6 UTP cable	
Environment Specifications		
Operating	Temperature: 0~55 degrees C Relative Humidity: 5~90% (non-condensing)	
Storage	Temperature: -10~60 degrees C Relative Humidity: 5~90% (non-condensing)	
Emission	FCC, CE	
Standard Accessories		
Packet Contents	Media Extender x 1 Quick Installation Guide x 1 Mounting Bracket x 2 Screws x 4 IR Emitter Cable x 1	Media Extender x 1 Quick Installation Guide x 1 Mounting Bracket x 2 Screws x 4 IR Receiver Cable x 1

1.5 Hardware Interface

1.5.1 Diagrams:

Transmitter:

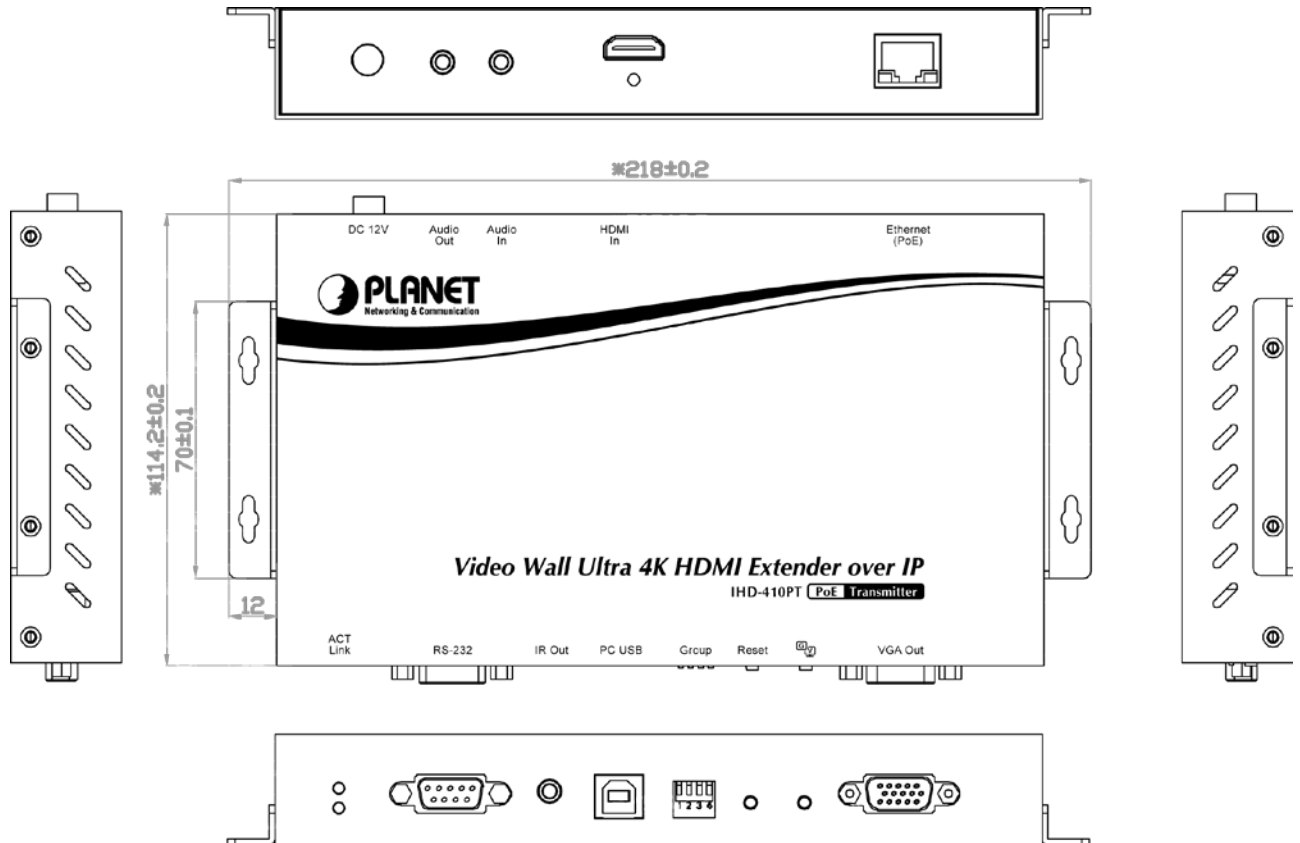

Receiver:

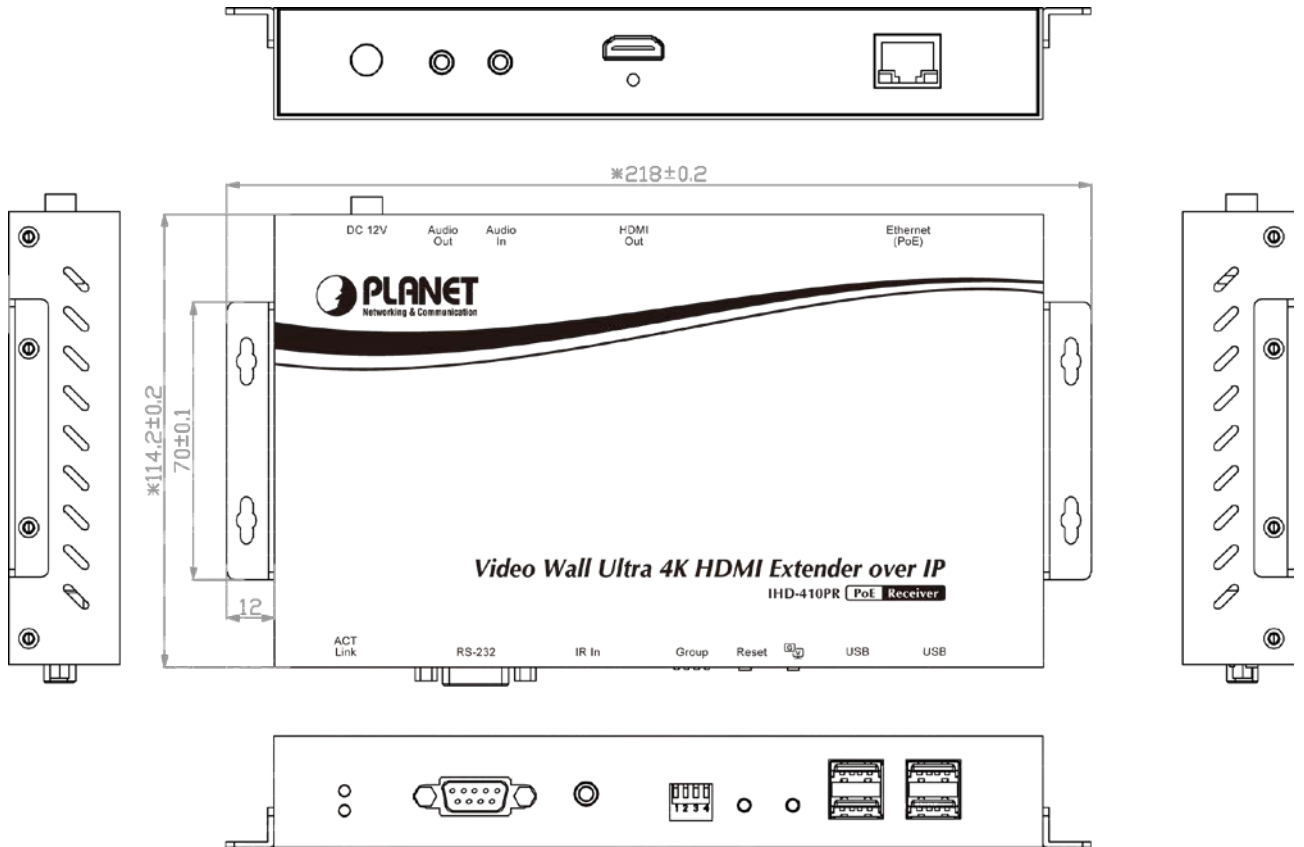

1.5.2 Interfaces:

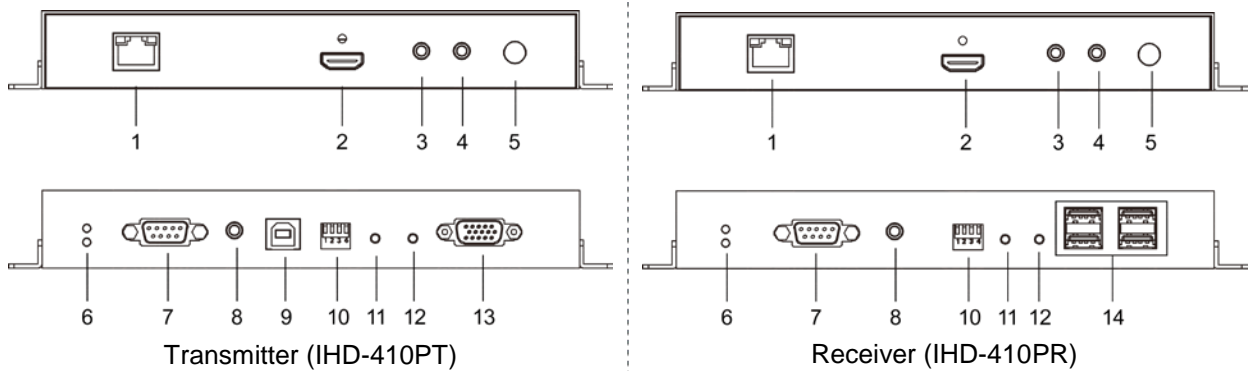

● **Interfaces Definition:**

Position	Description	Function
1	Ethernet (PoE)	<ul style="list-style-type: none"> ● Connect to a LAN Switch. IGMP snooping and jumbo frame supported Gigabit IEEE 802.3af/at PoE+ Ethernet switch is recommended. ● LED: <ol style="list-style-type: none"> 1. LAN LED (green color): This LED will be flashing while network is accessing via Ethernet. 2. Power LED (orange color): When the device is powered on, and the device is connected to Ethernet

Position	Description	Function
		switch, the LED will be always on.
2	HDMI	Transmitter: HDMI Type-A female connector for connecting to the HDMI source. Receiver: HDMI Type-A female connector for video output.
3	Audio In	3.5mm jack for connecting an external active microphone.
4	Audio Out	3.5mm jack for connecting an active loud speaker.
5	DC 12V	12V/2A DC power input. Only use one power source, either from DC or from 802.3af/at PoE+ Ethernet switch.
6	ACT/Link	<ul style="list-style-type: none"> ● ACT: ACT LED indicator turns blue when the device is powered up. ● Link: Link LED indicator flickers green when network connection is waiting for video source, and turns green when network connection and video source are functioning properly.
7	RS232	DB-9 female connector for RS232 bi-directional remote extension.
8	IR	Transmitter: 3.5mm jack for IR emitter cable to control video source device. Receiver: 3.5mm jack for IR receiver cable to receive signal from remote controller.
9	PC USB	USB host input port.
10	Group	Group configuration, 4-bit switch for 16 stream channel selection.
11	Reset	<p>This button supports two functions: "Restore to factory default setting" and "stop connecting to video source".</p> <ul style="list-style-type: none"> ● Restore to factory default setting: <ol style="list-style-type: none"> 1. Turn off the device first. 2. Press and hold the reset button, and then turn on the device. Keep pressing the reset button until the ACT and Link LED flash. 3. Turn off the device and back on. Once the device is operational again, it has restored to default settings. ● Stop connecting to video source: <ol style="list-style-type: none"> 1. Turn on the device first. 2. Press and hold the reset button for 1 second; the link LED will turn off; the device does not connect to video source. 3. Press and hold the reset button for 1 second again; the link LED will turn on; the device will connect to video source again.
12	G/V Mode	Press the button for 1 second to select Graphic Mode or Video Mode (also deploy to all the IHD-200PT and IHD-200PR of the same channel)
13	VGA Out	DB9 connector for VGA local display
14	USB	USB ports for additional USB devices such as USB mouse, USB keyboard and USB pen drive.

1.6 Device Connection Topology

PLANET IHD-410PT and IHD-410PR work as a pair to facilitate the management tool and HDMI display over IP Ethernet with PoE.

Video Extender

The IHD-410PT and IHD-410PR are able to send the same video signal to multi-monitors in different locations at the same time. It helps to quickly extend the image and commercial to the public efficiently in such places as expos, food courts, boardrooms, and any public areas.

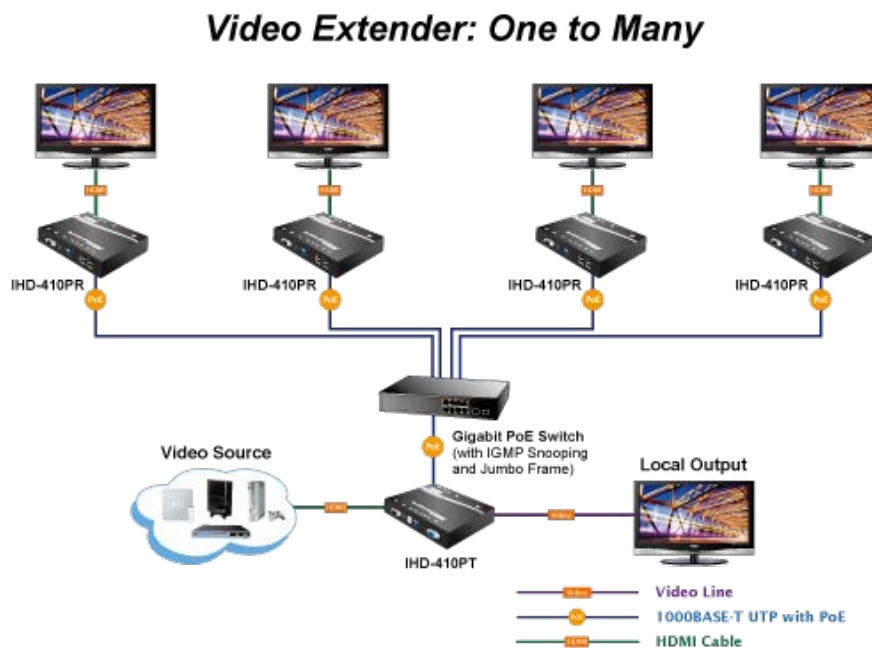

Video Wall

To bring the image and picture in larger size over video wall, the IHD-410PT and IHD-410PR are the ideal solution to distributing one specified image, picture, or video to multiple screens which are usually applicable for sports, department stores, movie theaters, etc.

Video Wall

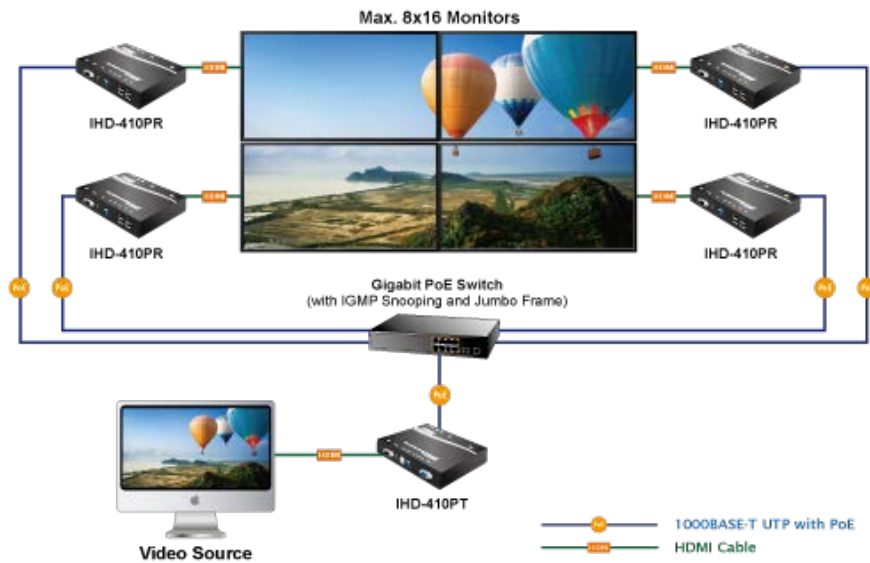

Ideal Solution for Wide Variety of Commercial Installation Environments

The IHD-410 series supports 100m over single Cat5e/6 cable at point to point, as well as point to many and many to many over Gigabit Ethernet switch. With so many practical features, the IHD-410 series is ideal for live presentations, public broadcasting, education training, boardrooms, etc.

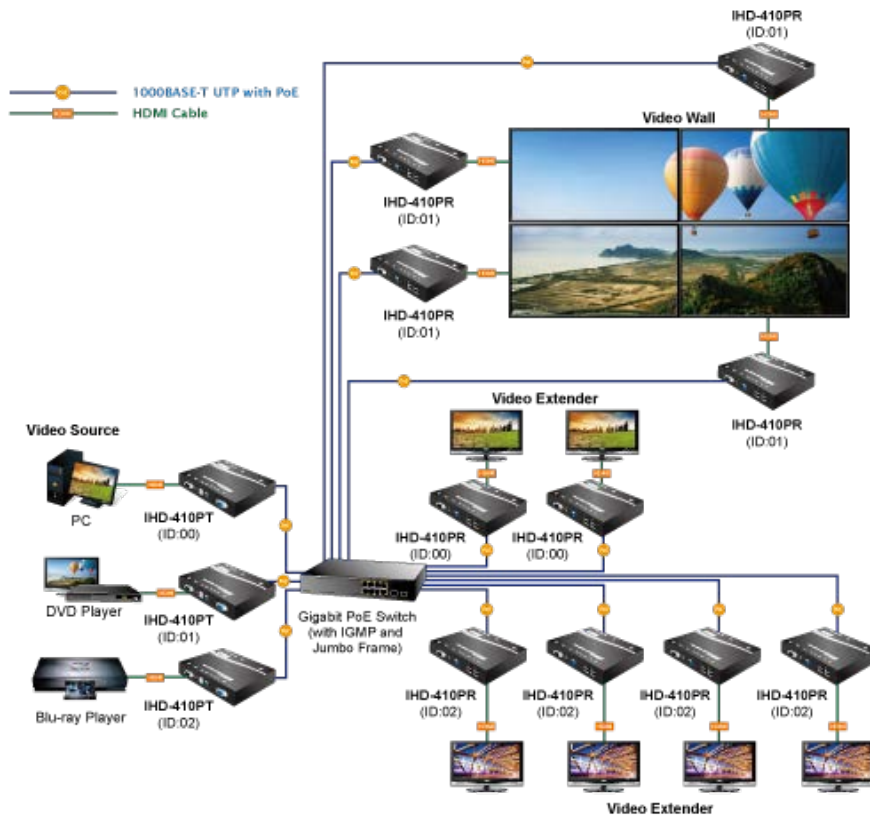

Chapter 2. Hardware Installation

2.1 Devices Requirements

1. Monitor: HDCP compliant monitors with HDMI interface for the HDCP video source.
2. Ethernet cable: Cat5/5e/6 UTP cable (EIA / TIA 568B industry standard compliant).
3. PoE Switch: Please see the recommended PoE switch.
4. PC OS: Windows XP/7/8.1/10.

Application	Recommended Ethernet Switch
Video Wall/Video Extend Application	Gigabit PoE Switch with IGMP snooping function and jumbo frame function.
Multiple Video Wall Application	10 Gigabit PoE Switch with IGMP snooping function, jumbo frame function and VLAN function.



The quality of the output signal will depend largely upon the quality of video source, cable and display device used. Low-quality cables degrade output signal causing elevated noise levels. Please use the proper cable and make sure the display device is capable of handling the resolution and refresh rate selected.

2.2 Installation Instructions

1. Connect the video source to the Transmitter (IHD-410PT) unit's HDMI In interface.
2. Connect the monitor to the Receiver (IHD-410PR) unit's HDMI Out interface.
3. Set an identical ID number on DIP switch for all units of the same group.
4. Connect the USB cables from Transmitter to PC, and connect the USB additional devices such as USB mouse, USB keyboard and USB pen drive to Receiver.
5. Use Cat5e/6 cables (EIA/TIA 568B industry standard compliant) for connection between Transmitter/Receiver and the IEEE 802.3af/at PoE+ switch.
6. Apply the proper power to all connecting devices.
7. Connect the IR emitter cable with Transmitter and the IR receiver cable with Receiver for remote control (optional).



Ensure that all devices are powered off before connecting to the unit.
Make sure all devices connected are properly grounded.
Place cables away from fluorescent lights and air conditioners that are likely to generate electrical noise.
Please allow adequate space around the unit for ventilation.

Chapter 3. Preparation

Before getting into the unit's web UI, user has to find out the device's IP address and configure PC's IP address.

3.1 Find the IP Address via Monitor

User is able to find the device's IP address via monitor. Please refer to the steps below:

1. Connect HDMI monitor to the Receiver (IHD-410PR) unit's HDMI Out interface.
2. Set an identical ID number on DIP switch for all units of the same group.
3. Use Cat5e/6 cables (EIA/TIA 568B industry standard compliant) for connection between Transmitter/Receiver and the IEEE 802.3af/at PoE+ switch.
4. Apply the proper power to the Transmitter, Receiver, switch and monitor.
5. The monitor will show the information shown below.

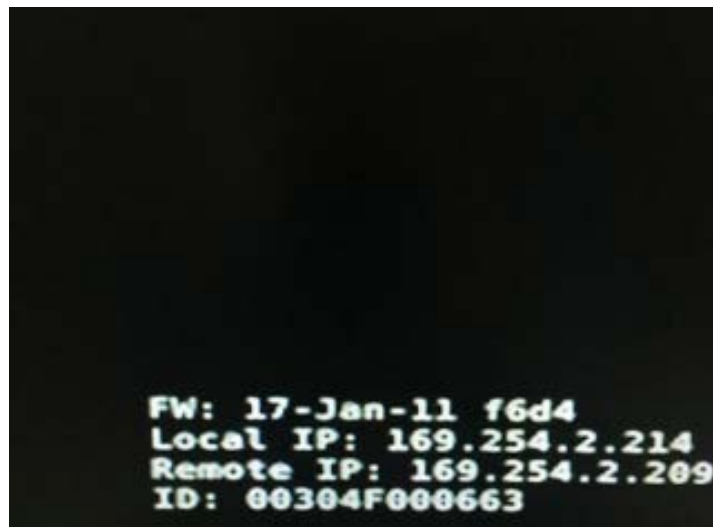

Description	Function
FW	Show the date of firmware.
Local IP	Show the IHD-410PR's IP address.
Remote IP	Show the connected IHD-410PT's IP address.
ID	Show the IHD-410PR's MAC address.

3.2 Find the IP Address via Bonjour Browser Software

The Bonjour Browser is a free third-party software. User is able to download it from internet. The supported Bonjour Browser version is shown below.

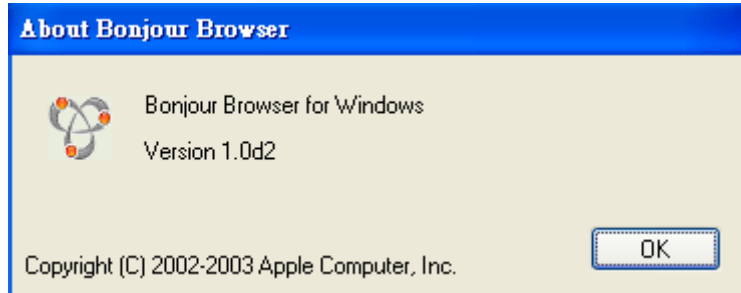

The following image is the interface of Bonjour Browser.

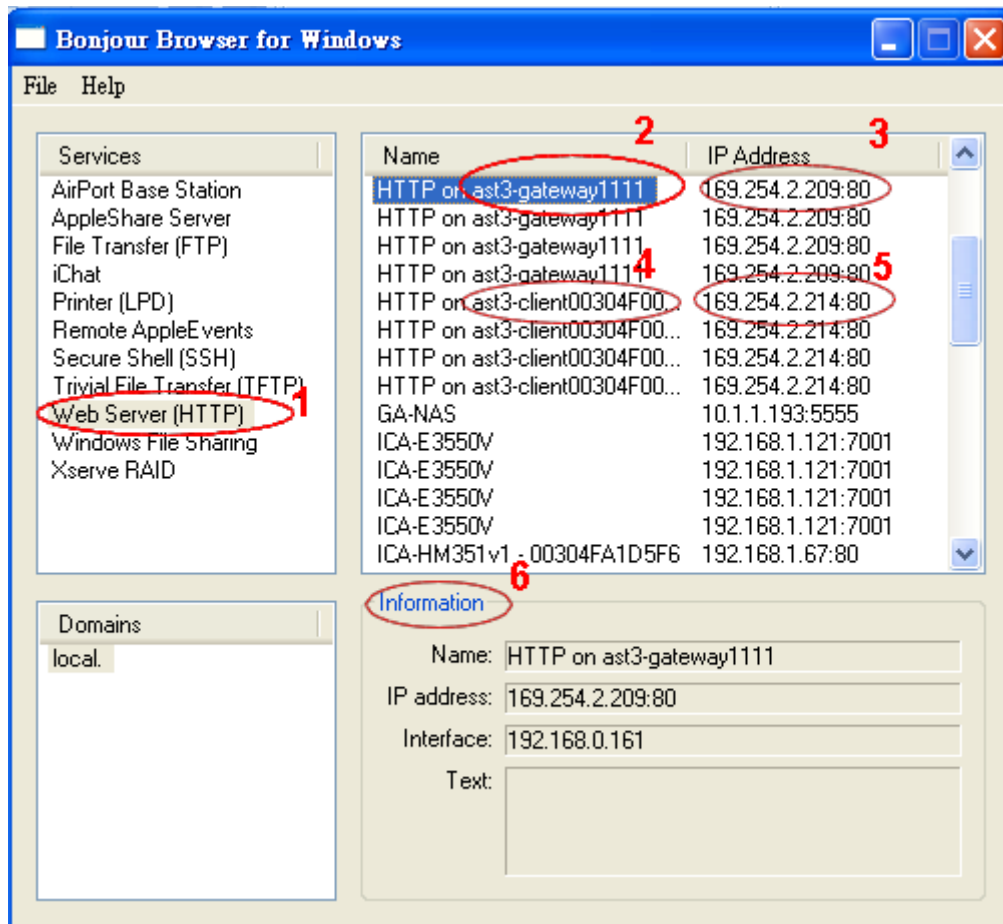

1. Click Web Server (HTTP) and theoretically, you can see all the devices connected to the same hub/switch (in the same LAN) that are shown on the right side of the grid.

2. Ast-gateway: It represents transmitter.

The four digits after ast-gateway depend on the position of the DIP switch you've set.

Default DIP switch is 0 and the four digits are 0000.

Please refer to the form below. For example, if the position is set to 7, then you'll see ast-gateway 1110.

DIP Switch	0	1	2	3	4	5	6	7
Four digits	0000	1000	0100	1100	0010	1010	0110	1110
DIP Switch	8	9	A	B	C	D	E	F
Four digits	0001	1001	0101	1101	0011	1011	0111	1111

1. The IP address of transmitter.
2. Ast-client: It represents receiver.
3. The IP address of receiver. Beware, even though the name of receivers are the same, you can tell the difference by the IP address.
4. You can see the information here.

3.3 Setting TCP/IP on your PC

The default IP address of the IHD-410 series is B class Networking:168.254.xxx.xxx, please set the IP address of the connected PC as static IP, such as 169.254.xxx.xxx and the sub mask as 255.255.0.0. Please refer to the following to set the IP address of the connected PC.

3.3.1 Windows XP

If you are using Windows XP, please refer to the steps below:

1. From the desktop, right-click My Network Places > Properties.

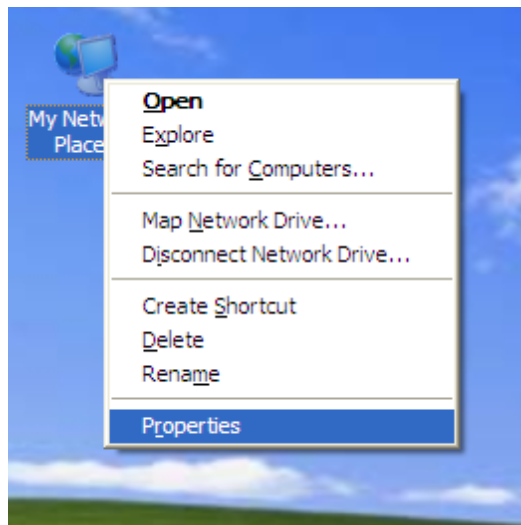

2. Right-click on the Local Area Connection and select Properties.

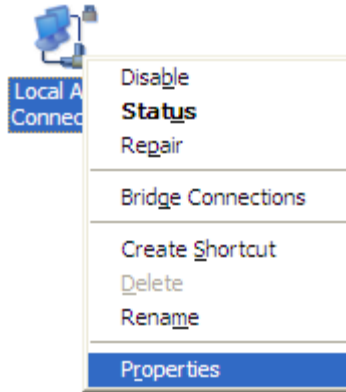

3. Select Internet Protocol (TCP/IP) and click Properties.

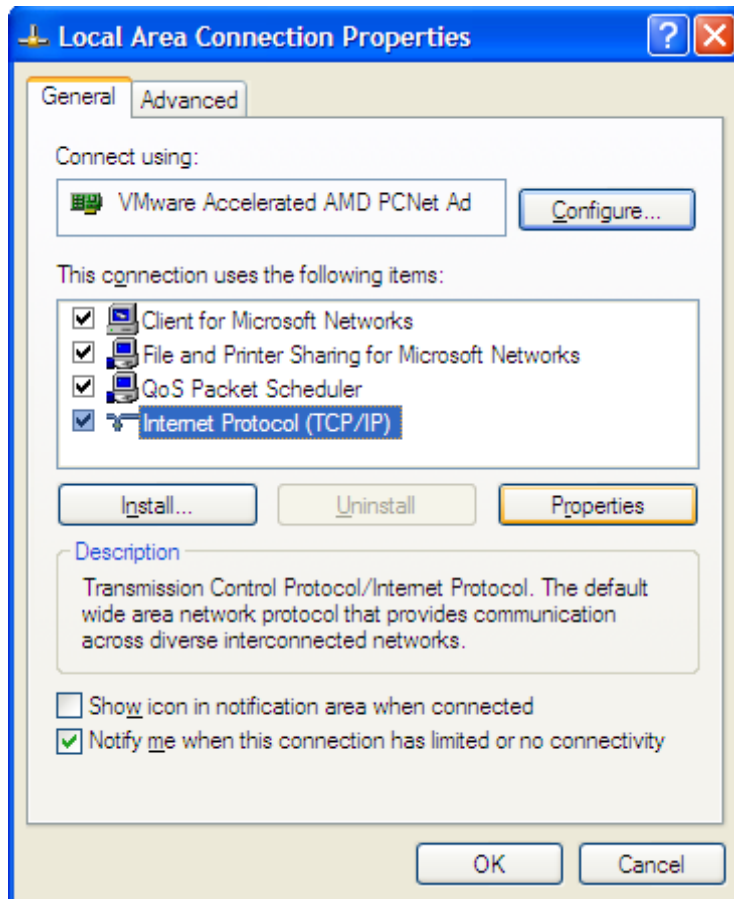

4. Select "Use the following IP address".

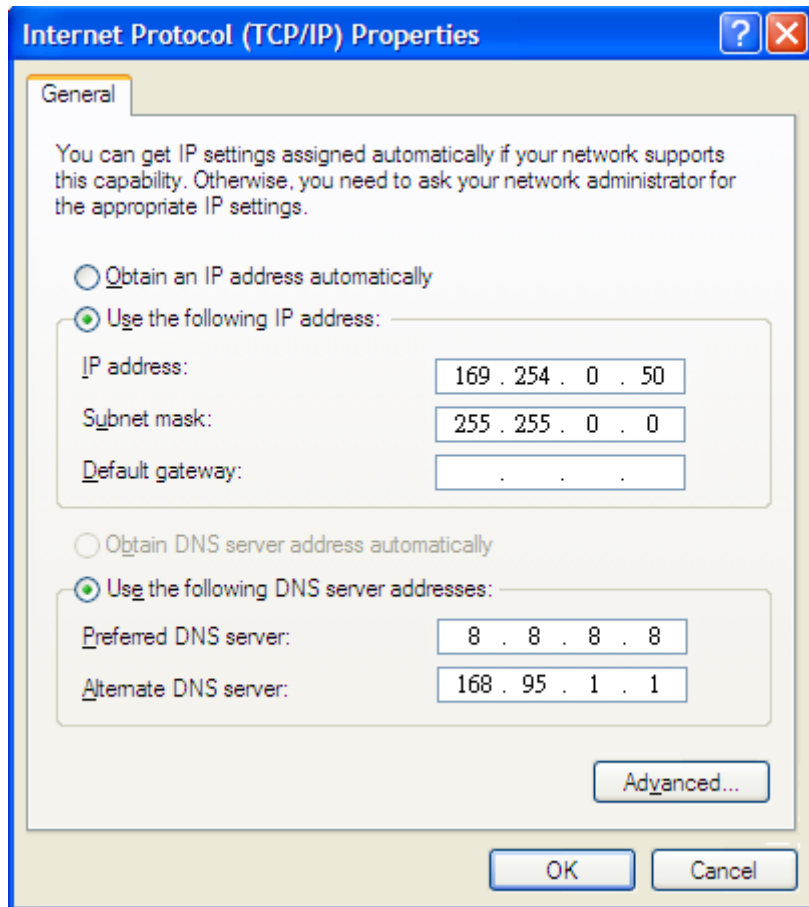

IP address: You have to set the same network segment between your PC's IP address and the transmitter/receiver.

For example, if the transmitter's IP is 169.254.0.1, then you should set your PC's IP address to 169.254.0.xxx where xxx can be any number between 2 and 253. (Same as receiver)

Subnet mask: Enter 255.255.0.0.

3.3.2 Windows 7

If you are using Windows 7, please refer to the following:

1. Click on the network icon from the right side of the taskbar and then click on "Open Network and Sharing Center".

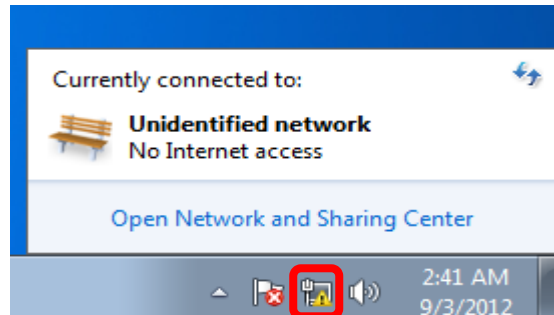

2. Click "Change adapter settings".

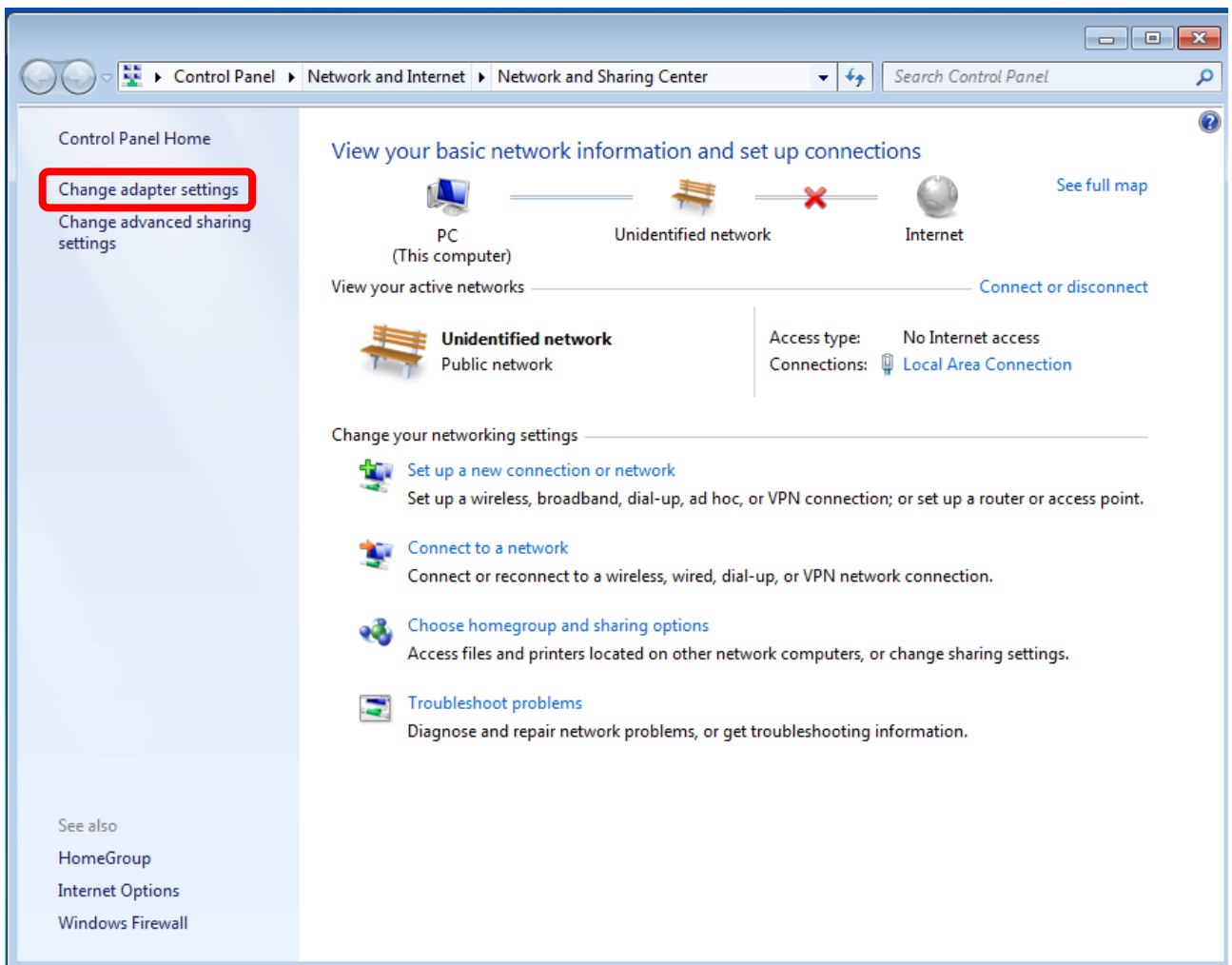

3. Right-click on the Local Area Connection and select Properties.

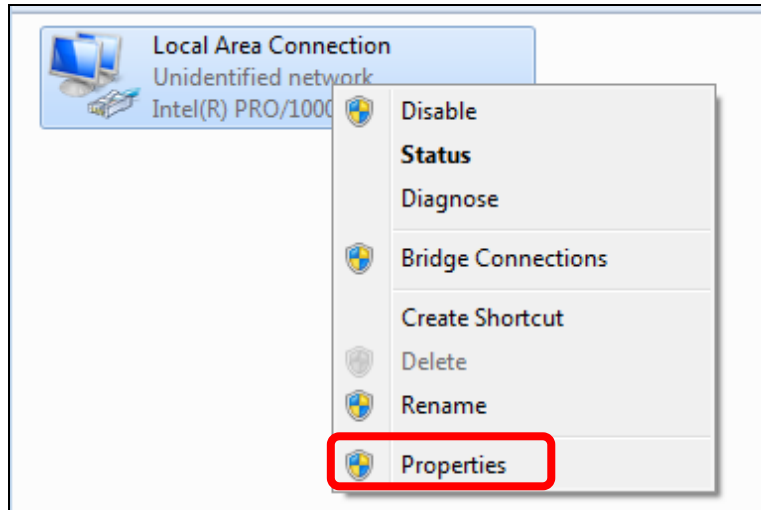

4. Select Internet Protocol Version 4 (TCP/IPv4) and click Properties or directly double-click on Internet Protocol Version 4 (TCP/IPv4).

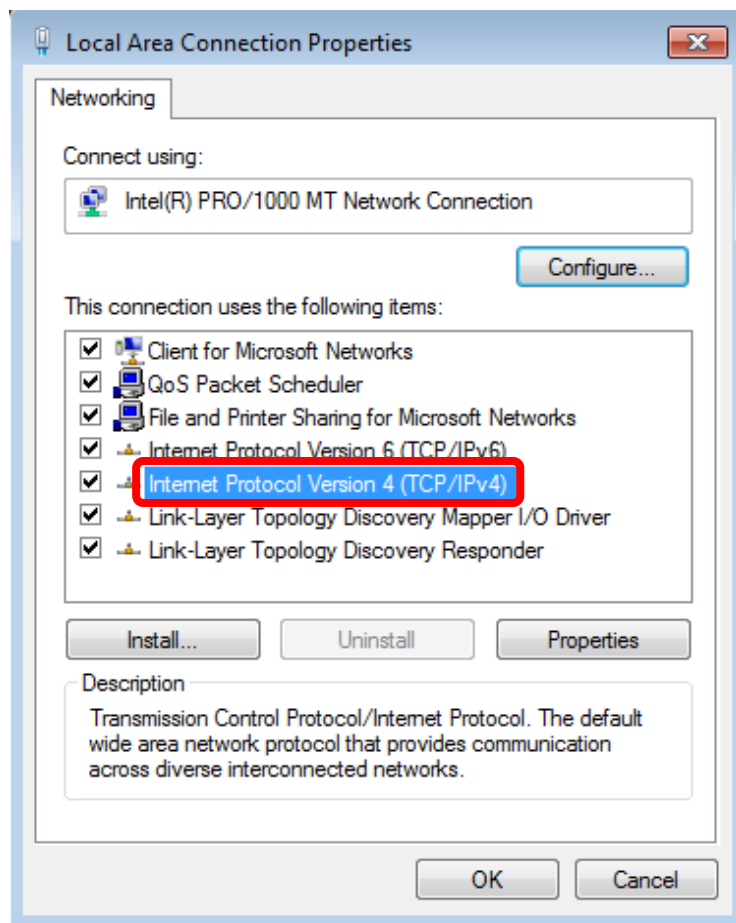

5. Select "Use the following IP address".

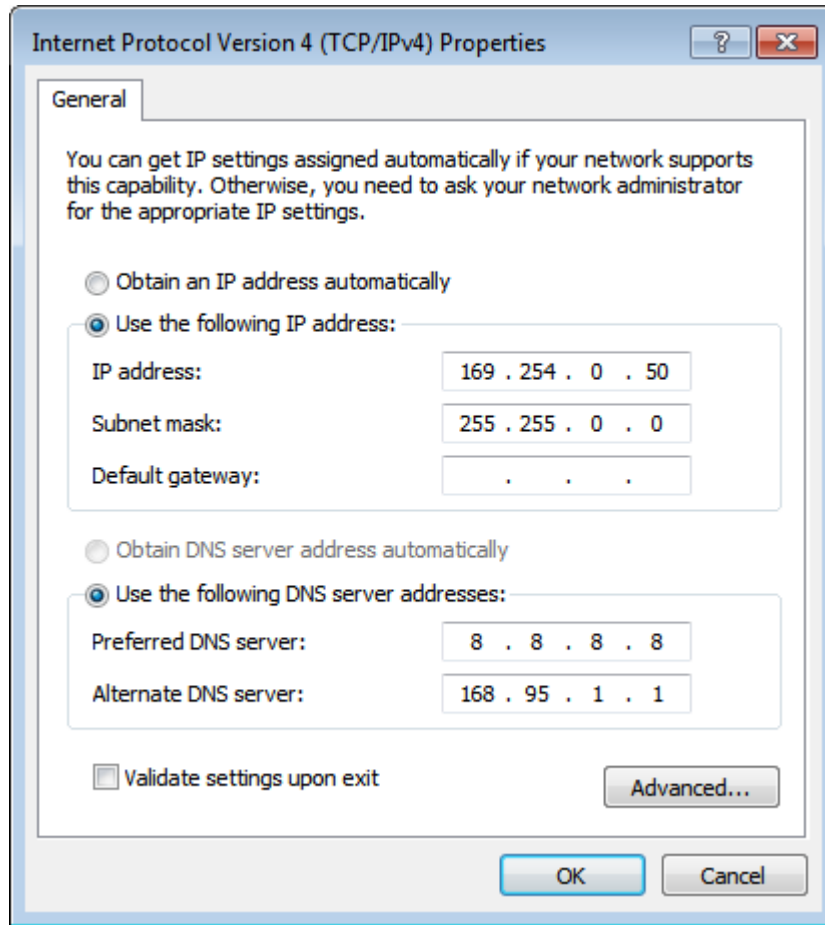

Select "Use the following IP address".

IP address: You have to set the same network segment between your PC's IP and the transmitter/receiver.

For example, if the transmitter's IP is 169.254.0.1, then you should set to 169.254.0.xxx where xxx can be any number between 2 and 253. (Same as receiver)

Subnet mask: Enter 255.255.0.0.

3.3.3 Windows 10

If you are using Windows 10, please refer to the following:

1. In the search box on the taskbar, type View network connections, and then select View network connections at the top of the list.

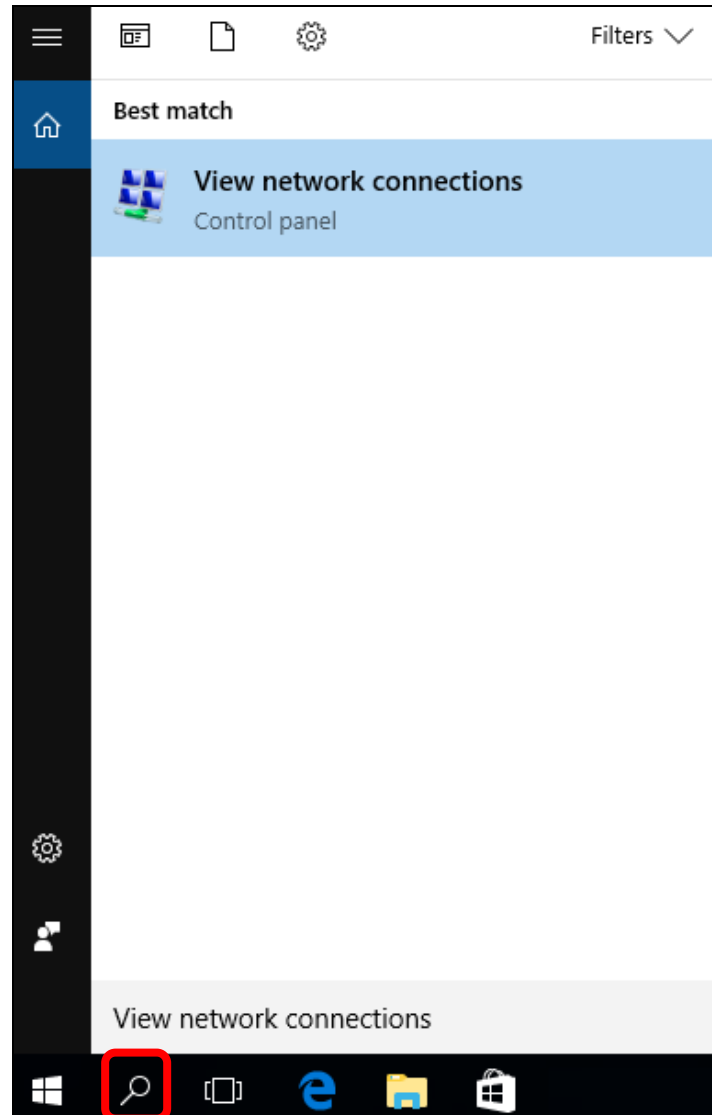

2. Right-click on the Local Area Connection and select Properties.

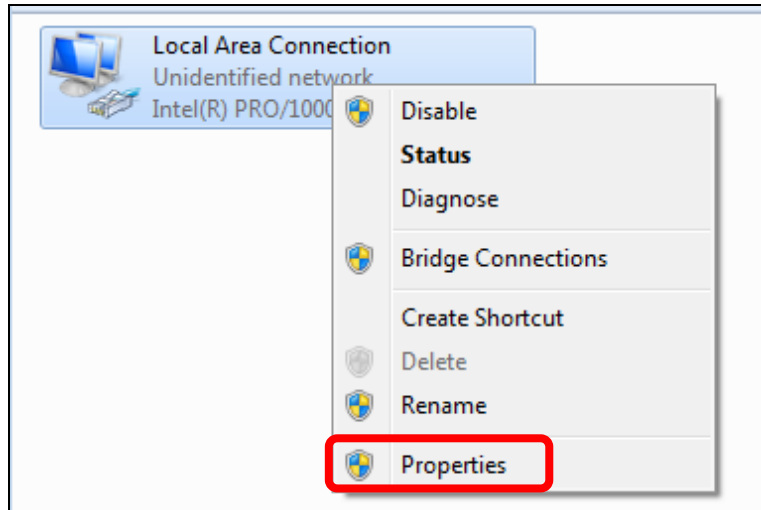

3. Select Internet Protocol Version 4 (TCP/IPv4) and click Properties or directly double-click on Internet Protocol Version 4 (TCP/IPv4).

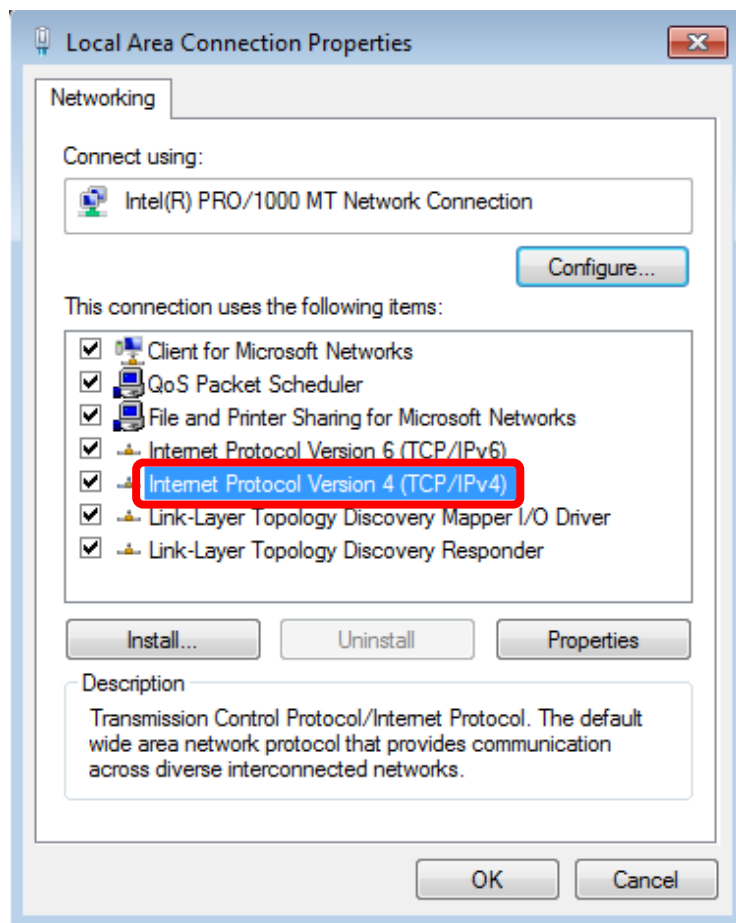

4. Select "Use the following IP address".

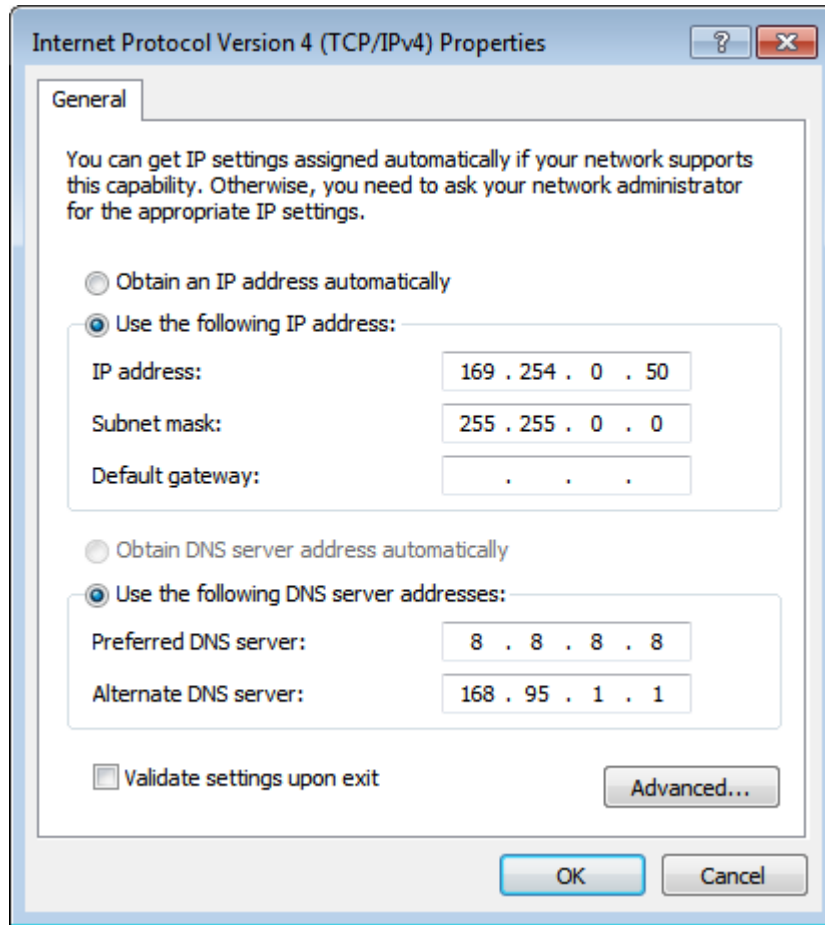

Select "Use the following IP address".

IP address: You have to set the same network segment between your PC's IP and the transmitter / receiver.

For example, if the transmitter's IP is 169.254.0.1, then you should set to 169.254.0.xxx where xxx can be any number between 2 and 253. (Same as receiver)

Subnet mask: Enter 255.255.0.0.

Chapter 4. Web-based Management

Before doing configuration, ensure that all remote displays and all network cables are connected correctly. (Video source is required.)

Double-click the device's name in Bonjour Browser and then get to the Web UI, or you can simply type the device's IP in the address bar. For example, input `http://169.254.xxx.xxx`.

If the link is successful, user will see the web page as follows:

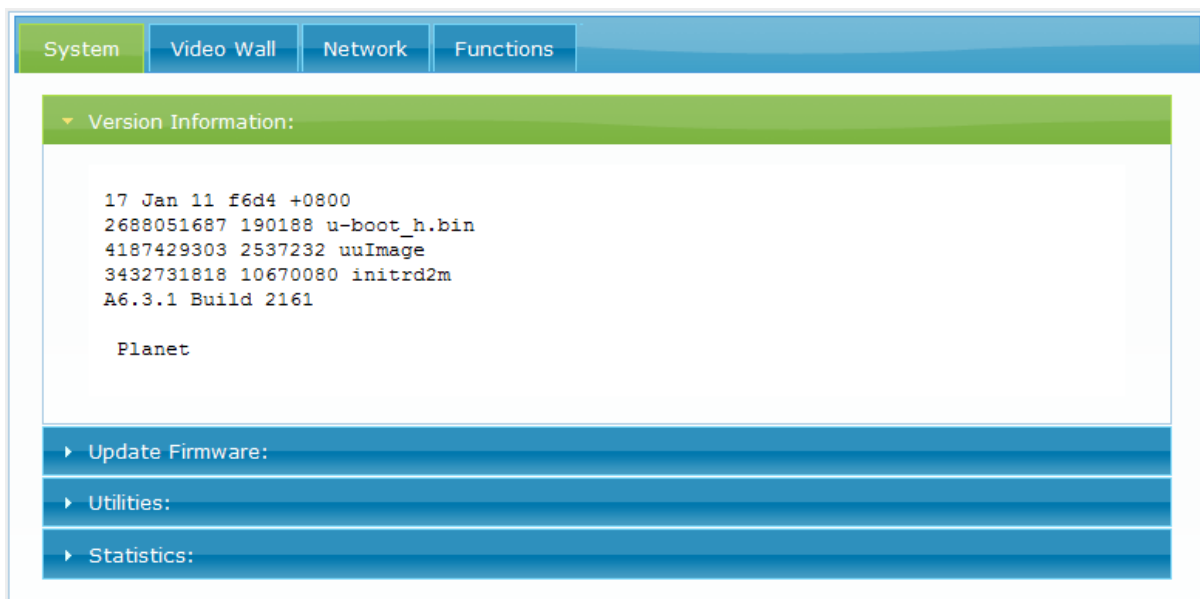

4.1 System

4.1.1 Version Information

Here user can see the current date and the firmware version information.

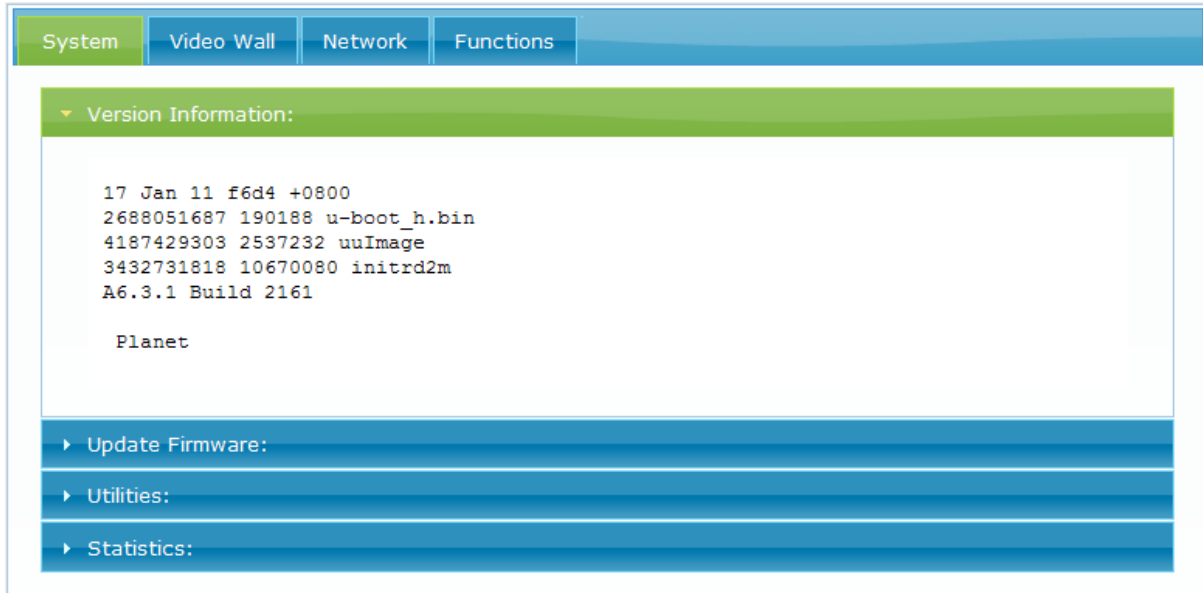

4.1.2 Update Firmware

Here is for user to update firmware. Some functions or issues may have to be improved by updating the firmware.

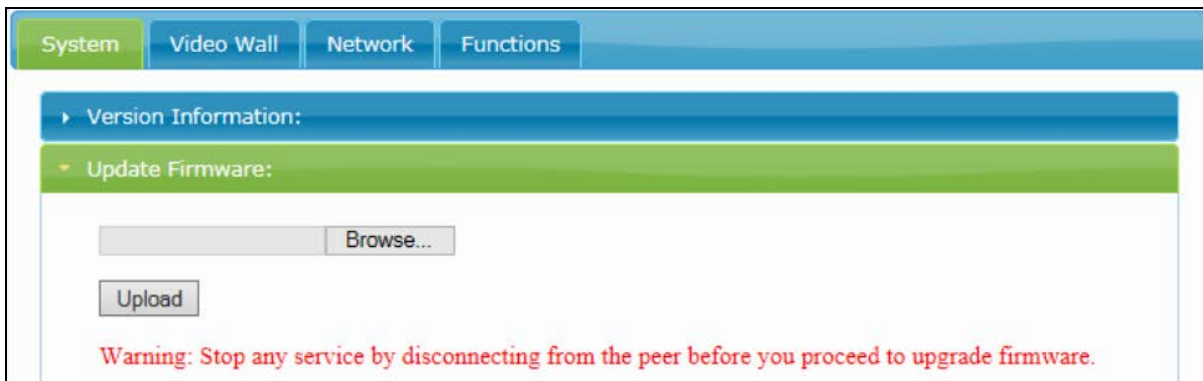

Note

1. If you want to update firmware for transmitter, please get to transmitter's Web UI; if you want to update firmware for receiver, please get to the receiver's Web UI.
2. There are two different kinds of firmware available: one for transmitter and the other for receiver. The transmitter firmware must be uploaded to the transmitter unit, and the receiver firmware must be uploaded to the receiver unit. Uploading the wrong firmware to the wrong unit will cause the unit to malfunction.

4.1.3 Utilities

User can restore the device to factory default setting, reboot device, reset EDID, even console API command is issued here. Usually, the API command is for engineers to use, but not for end users.

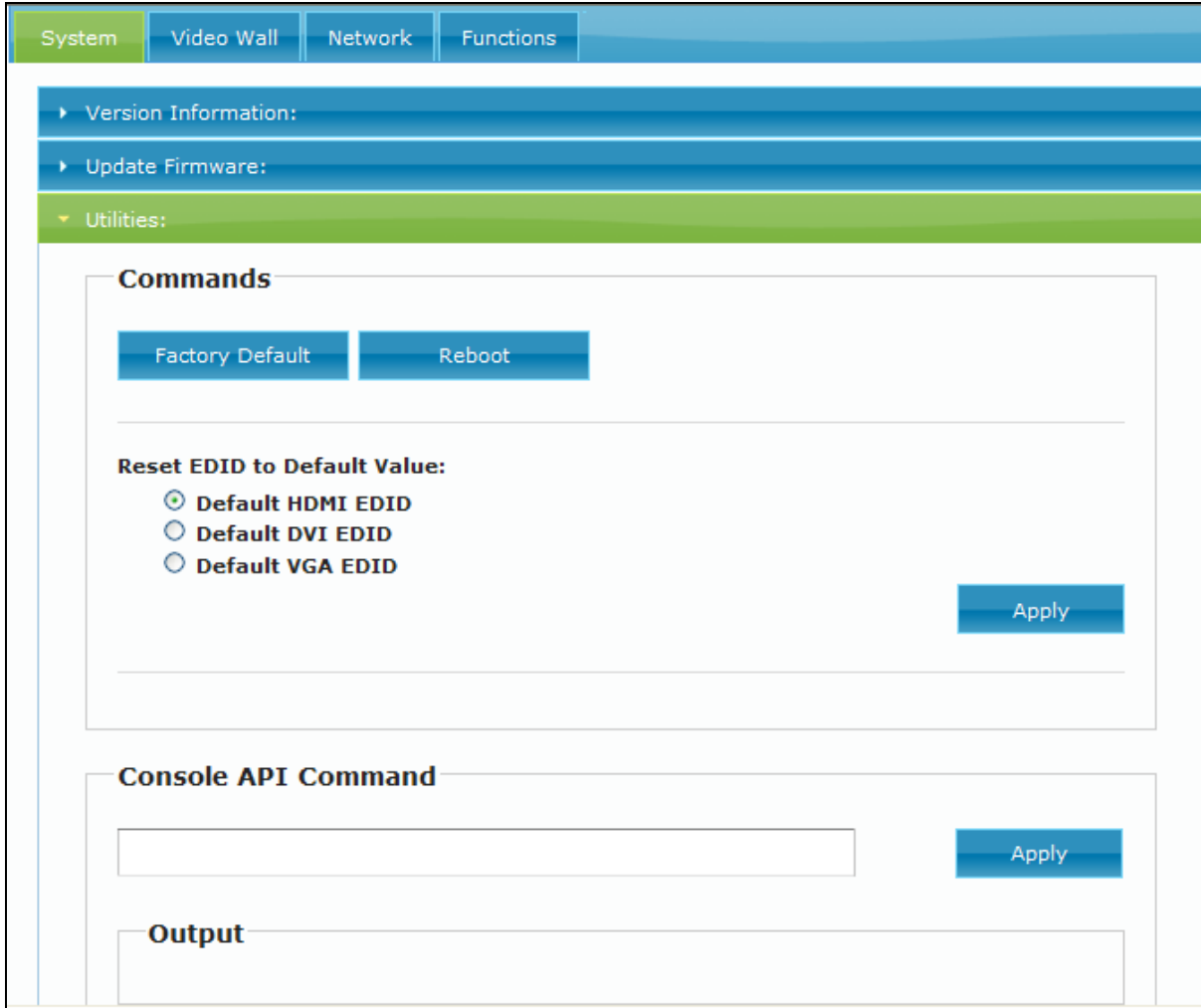

The screenshot shows the PLANET web interface with the following structure:

- Navigation tabs: System, Video Wall, Network, Functions.
- Menu items: Version Information, Update Firmware, Utilities (expanded).
- Commands** section:
 - Buttons: Factory Default, Reboot.
- Reset EDID to Default Value:** section:
 - Radio buttons: Default HDMI EDID, Default DVI EDID, Default VGA EDID.
 - Button: Apply.
- Console API Command** section:
 - Text input field.
 - Button: Apply.
- Output** section: (Empty text area).

4.1.4 Statistics

Below is the detailed information on ID, IP, unit status, casting mode, etc.

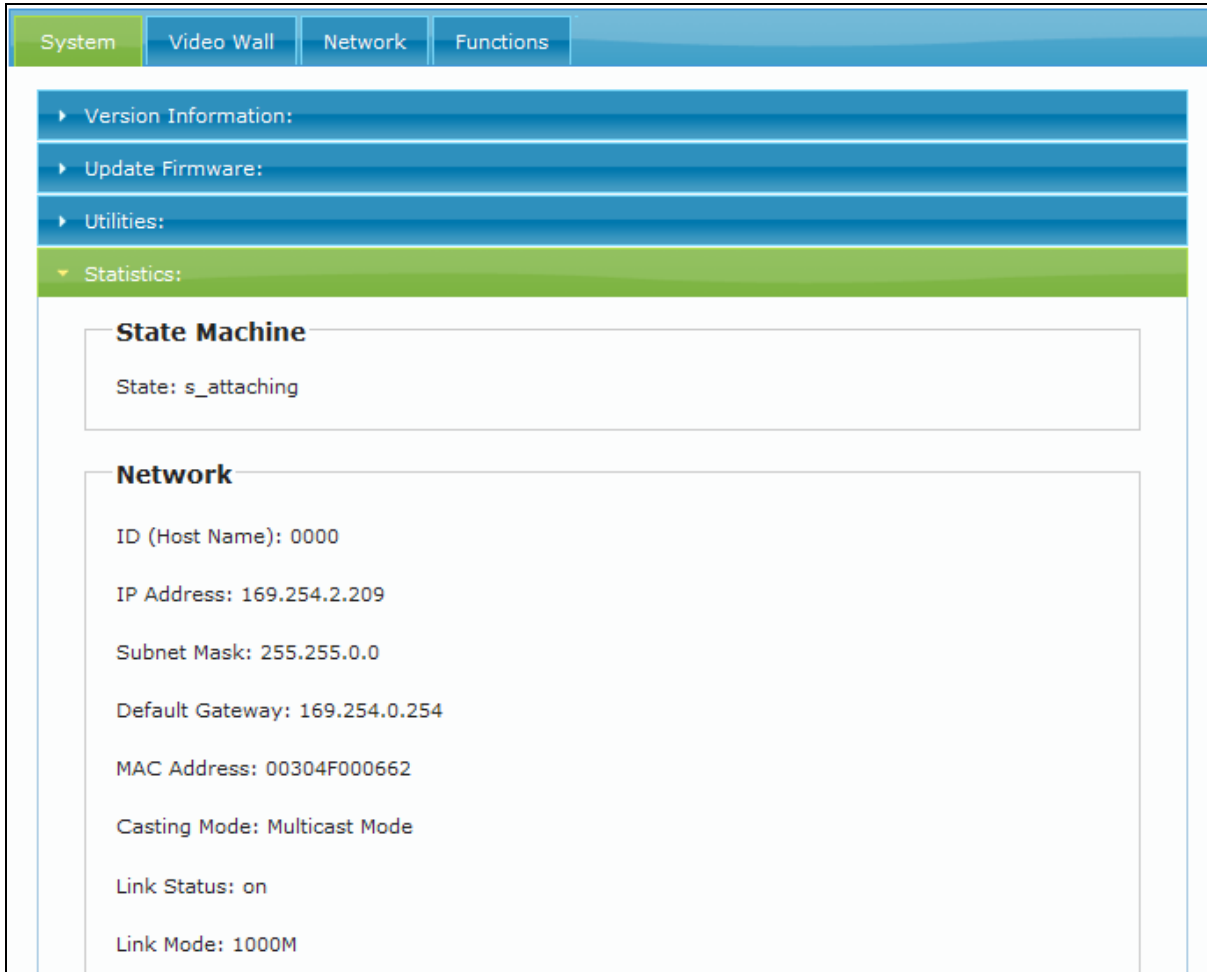

The screenshot displays the web interface of the device. At the top, there is a navigation bar with four tabs: 'System', 'Video Wall', 'Network', and 'Functions'. Below the navigation bar, there is a list of menu items: 'Version Information:', 'Update Firmware:', 'Utilities:', and 'Statistics:'. The 'Statistics:' item is expanded, showing two sections: 'State Machine' and 'Network'. The 'State Machine' section shows 'State: s_attaching'. The 'Network' section shows the following details: ID (Host Name): 0000, IP Address: 169.254.2.209, Subnet Mask: 255.255.0.0, Default Gateway: 169.254.0.254, MAC Address: 00304F000662, Casting Mode: Multicast Mode, Link Status: on, and Link Mode: 1000M.

4.2 Video Wall

4.2.1 Basic Setup

Click on Video Wall Setup tab for Basic Setup first.

System
Video Wall
Network
Functions

Basic Setup:

Bezel and Gap Compensation

OW:

OH:

VW:

VH:

UNIT: 0.1mm

Wall Size and Position Layout

Vertical Monitor Count:

Horizontal Monitor Count:

Row Position:

Column Position:

UNIT: Panel

Preferences

Stretch Type:

Clockwise Rotate:

Apply To: "All" device(s) in the list

Apply

Show OSD

4.2.1.1 Bezel and Gap Compensation:

OW = Outside Width	OH = Outside Height
VW = View Width	VH = View Height

Adjust dimensions (mm) for the monitors of video wall. If you don't need this, just set all values "OW=VW, OH=VH." And please note that the unit is 0.1mm and the value must be an integer.

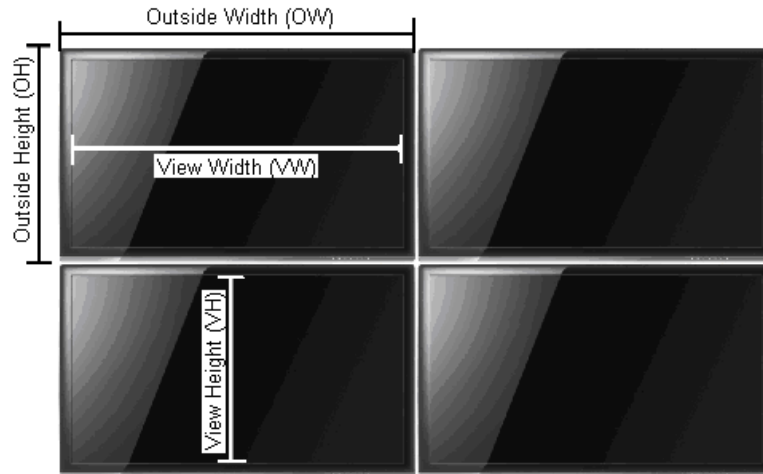

Basic Setup:

Bezel and Gap Compensation

OW:

OH:

VW:

VH:

UNIT: 0.1mm

4.2.1.2 Wall Size and Position Layout:

Step 1

Vertical Monitor Count x Horizontal Monitor Count: If the video wall is 2 x 2, then set up Vertical Monitor Count and Horizontal Monitor Count as 2. (Maximum: 8 x 16)

Wall Size and Position Layout

Vertical Monitor Count:
2

Horizontal Monitor Count:
2

Row Position:
0

Column Position:
0

UNIT: Panel

Step 2

Apply To: Select "All" and check the "Apply" button for your settings and all screens will refresh.

Apply To: "All" device(s) in the list

All

Show OSD

4.2.1.3 Configuring row and column position for each display

- OSD: On-Screen Display. The system automatically assigns a number to each monitor.

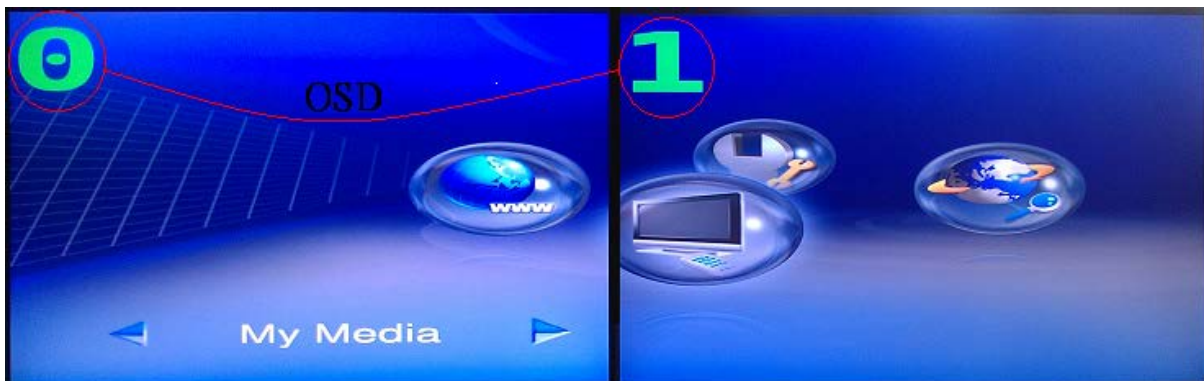

User can according to the number do individual control with the corresponding receiver's IP.

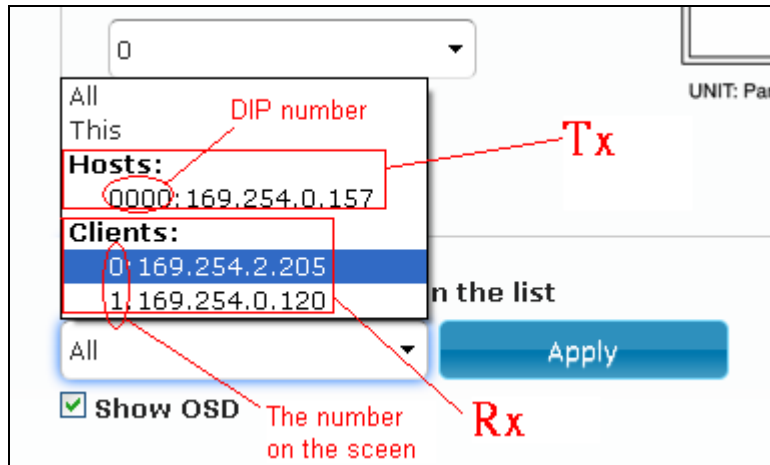

- Vertical Monitor Count: The number of monitors on vertical line.
- Horizontal Monitor Count: The number of monitors on horizontal line.
- Row Position: Set up row position for a monitor. For example, if the monitor is situated on the 1st row, the row position should be 0; if the monitor is situated on the 2nd row, the row position should be 1.
- Column Position: Set up column position for a monitor. For example, if the monitor is situated on the 1st column, the column position should be 0; if the monitor situated is on the 2nd column, the column position should be 1.

4.2.1.4 Preferences:

Select the video fit in the screen or stretch out and the rotate angle

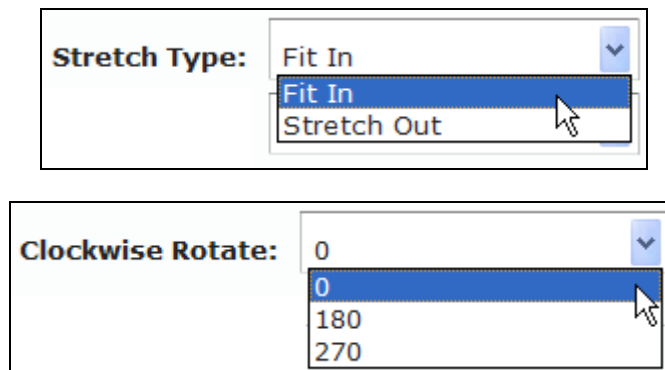

4.2.2 Setup Steps (Examples)

4.2.2.1 1 x 2 video extender

If you want to set a 1 x 2 “video extender” as shown in the following picture, you may refer to the following table and see the steps below:

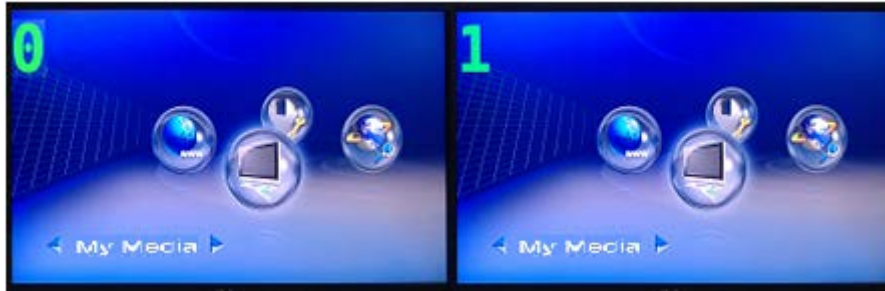

OSD	0	1
Vertical Monitor Count	1	1
Horizontal Monitor Count	1	1
Row Position	0	0
Column Position	0	0

4.2.2.2 1 x 2 video wall

If you want to set a 1 x 2 “video wall” as shown in the following picture, you may refer to the following table and see the steps below:

Step 1

Show OSD: Check this item and all monitors will show their number on the screen.



Step 2

Wall Size and Position Layout: Decide which part of the screen will be applied to a monitor.

OSD	0	1
Vertical Monitor Count	1	1
Horizontal Monitor Count	2	2
Row Position	0	0
Column Position	0	1

Step 3

Apply To: Select one of the clients by the OSD number for configuring the video wall setting one by one.



After all settings are done, you can uncheck OSD item.

4.2.2.3 2 x 2 video wall

Step 1

Show OSD: Check this item and all monitors will show their number on the screen.

Show OSD

Step 2

Wall Size and Position Layout: Decide which part of the screen will be applied to a monitor.

OSD	0	1	2	3
Vertical Monitor Count	2	2	2	2
Horizontal Monitor Count	2	2	2	2
Row Position	0	0	1	1
Column Position	0	1	0	1

To set up “Row Position” and “Column Position”, you are able to refer to the coordination below:

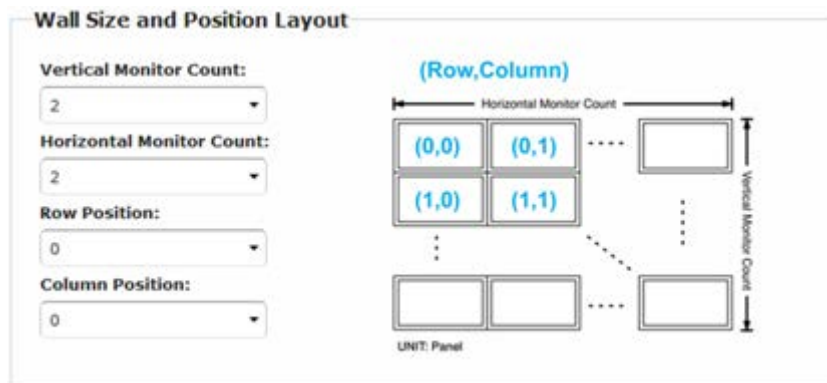

Step 3

Apply To: Select one of the clients by the OSD number for configuring the video wall setting one by one.

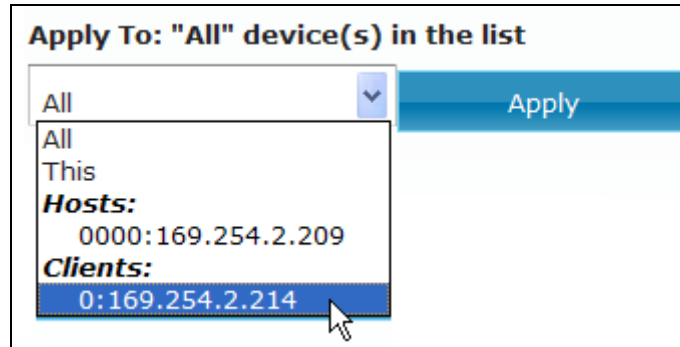

 **Note** For video wall application, it is NOT suggested to set up your screen array as N (row) x 1 (column) when horizontal resolution is greater than 1280 pixels.

4.2.3 Advanced Setup

After the Basic Setup is done, users may enter this tab for advanced setting. Please note that each monitor should have its own part of the screen section and does not overlap.

Step 1: Choose Control Target

Show OSD: Check this item and all monitors will show their number on the screen

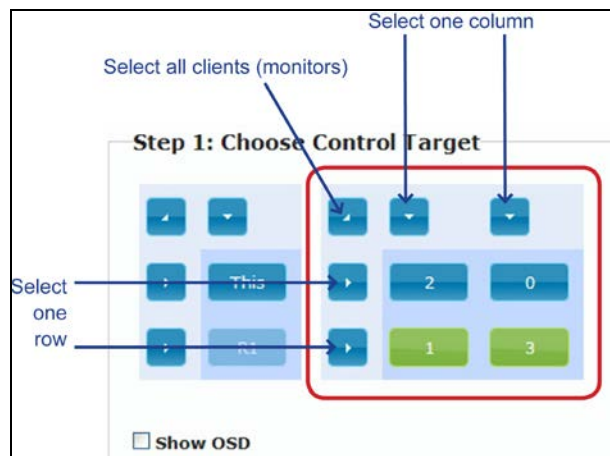

Step 2: Control Options

Step 2: Control Options

Reset to Basic Setup:

Stretch Type:

Clockwise Rotate:

Screen Layout (Row x Column):

x

Row Position:

Column Position:

Horizontal Shift:

Vertical Shift:

Horizontal Scale Up (N pixels/column_count):

Vertical Scale Up (N pixels/row_count):

Console API Command:

Description	Function
Reset to Basic Setup	If users make incorrect operations, press “Reset” to restore basic setup.
Stretch Type	Set up the video output to “Fit In” or “Stretch Out” mode in the screen.
Clockwise Rotate	Set up the rotation angle of the video output.

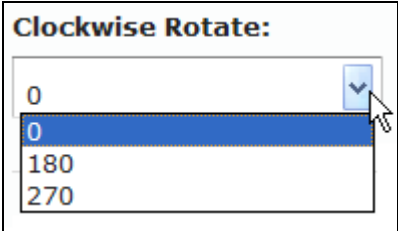
Description	Function
	
Screen Layout	Set up the number of vertical and horizontal monitor based on the video wall layout. Vertical number 1~8 and horizontal number 1~16.
Row Position	Set up the row position of monitor, number from 0 to the total number of vertical monitor.
Column Position	Set up the column position of monitor, number from 0 to the total number of horizontal monitor.
Horizontal Shift	Set up the video horizontal shift, left or right.
Vertical Shift	Set up the video vertical shift, up or down.
Horizontal Scale Up & Vertical Scale Up	It is not suggested to configure these two items for it may result in flickering images.
Consol API Command	Input Linux command to do advanced setup. The API command is usually for engineers to use, but not for end users.

4.3 Network

User can set the IP mode of each unit here and also can change the casting mode.

4.3.1 IP Setup

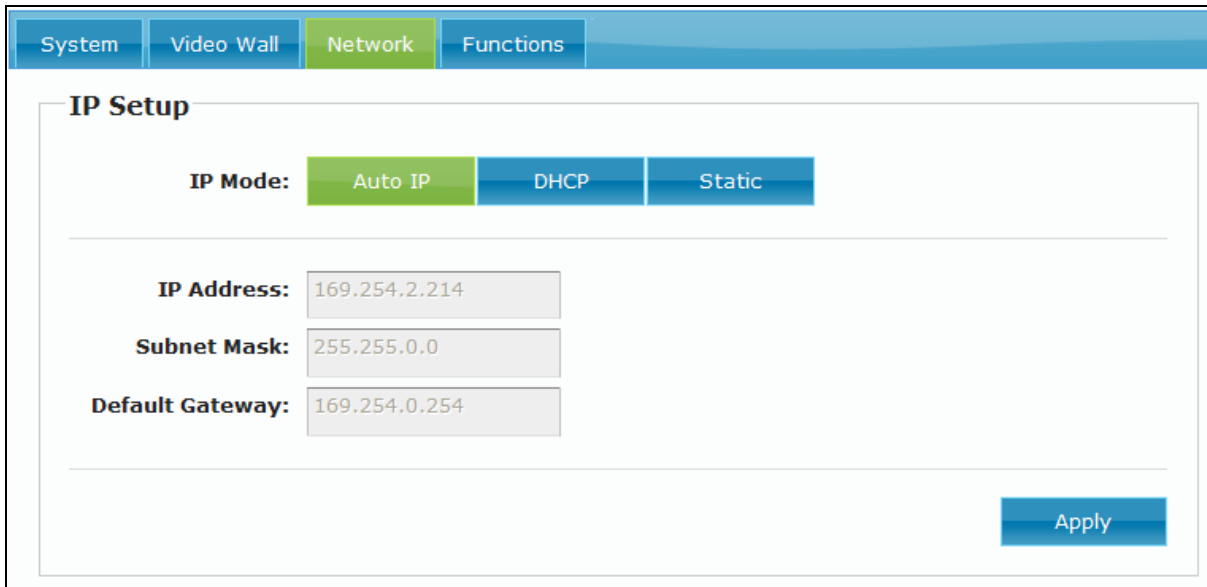

Description	Function
Auto IP	By default, each device is auto IP mode; the IP is 169.254.xxx.xxx.
DHCP	IP dispatched from DHCP server.
Static	Set the IP address manually.

4.3.2 Casting Mode

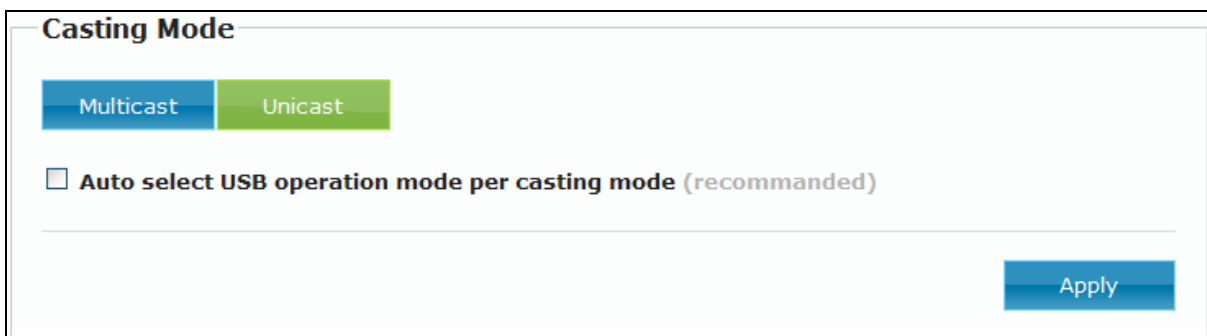

Description	Function
Multicast	Multicast is a true broadcast. The multicast source relies on multicast-enabled routers to forward the packets to all client subnets that have clients listen.

Unicast	Unicast is a one-to-one connection between the client and the server. Unicast uses IP delivery methods such as Transmission Control Protocol (TCP) and User Datagram Protocol (UDP), which are session-based protocols.
----------------	---

4.4 Function

Here user can make settings for IHD-410 series.

4.4.1 Video over IP

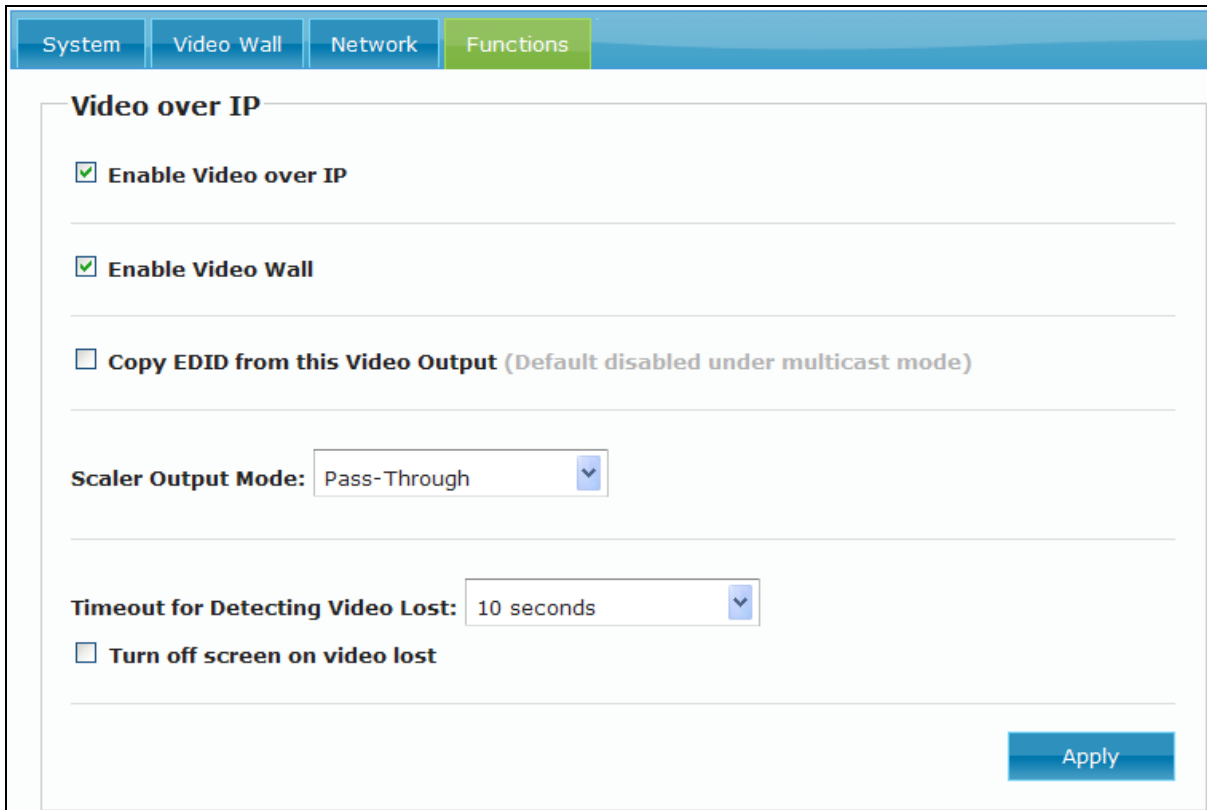

The screenshot shows the 'Functions' tab with the following settings:

- Enable Video over IP
- Enable Video Wall
- Copy EDID from this Video Output (Default disabled under multicast mode)
- Scaler Output Mode: Pass-Through
- Timeout for Detecting Video Lost: 10 seconds
- Turn off screen on video lost

An 'Apply' button is located at the bottom right of the settings panel.

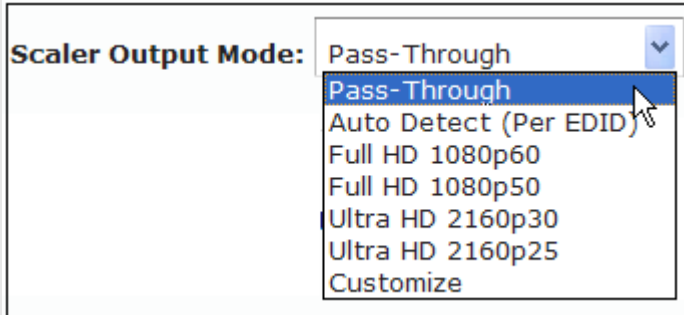
Description	Function
Enable Video over IP	By default, the function is set as enable. If users uncheck this item, then it can't work.
Enable Video Wall	By default, the function is set as enable. If users uncheck this item, then video wall function can't be used.
Copy EDID from this Video Output	User can copy the EDID from this Rx to other Rxs (the same group) with the same ID.
Scaler Output Mode	Select the required scaler output mode. 

Description	Function
<p>Timeout for Detecting Video Lost</p>	<p>Set up the time of stopping the video when detecting video lost. By default, the time is 10 seconds.</p> <div style="border: 1px solid black; padding: 5px;"> <p>Timeout for Detecting Video Lost: 10 seconds ▼</p> <p><input type="checkbox"/> Turn off screen on video lost</p> <div style="border: 1px solid black; padding: 2px; margin-top: 5px;"> <p>3 seconds</p> <p>5 seconds</p> <p style="background-color: #0070C0; color: white;">10 seconds</p> <p>20 seconds</p> <p>30 seconds</p> <p>60 seconds</p> <p>Never Timeout</p> </div> </div>

4.4.2 USB over IP

USB over IP

Enable USB over IP

Operation Mode:

Auto select mode (Recommended, choose per network casting mode)
 Active on link (Unicast network's default mode)
 Active per request (Multicast network's default mode)

Compatibility Mode:

K/M over IP (Uncheck when mouse/keyboard/touch panel not working as expected)

Apply

Description	Function
<p>Enable USB over IP</p>	<p>Check it to enable USB extension mode over IP.</p>
<p>Operation Mode</p>	<p>Including “auto select mode”, “active on line” and “active per request” modes for option.</p>
<p>Compatibility Mode</p>	<p>Check to enable USB keyboard; USB mouse transmission mode.</p>

4.4.3 Serial over IP

Usually, it is recommended that the Serial over IP function is for engineer to use, but not for end users. Please do not change the settings.

Serial over IP

Enable Serial over IP

Operation Mode:

Type 1 (Need extra control instruction. For advanced usage.)
 Type 2 (Recommended. Dumb redirection.)
 Type 1 guest mode
 Type 2 guest mode

Baudrate Setting for Type 2:

Baudrate: ▼
Data bits: ▼
Parity: ▼
Stop bits: ▼

[Apply](#)

Description	Function
Enable Serial over IP	If users uncheck this item, then serial 2 can't be used.
Operation Mode	Type 1 and Type 1 guest modes have to do other commands. Type 2 (extender transmit) and Type 2 guest mode use telnet through port 6752. (Usually, the function is for engineer to use, but not for end users.)
Baud Rate Setting	Set baud rate for the unit. By default, the baud rate is 115200.

APPENDIX A. Troubleshooting & Frequently Asked Questions

Q1: Where is the Bonjour Browser Software?

A:

Basically, there are so many third-party search tools that can be used, as long as you can find the IP of the unit. If you want to use Bonjour Browser, please e-mail to us (support@planet.com.tw) and we will provide it to you.

Q2: What kind of switch should user use for this product?

A:

It is recommended to use the switch which supports Gigabit PoE, Jumbo Frame functions and IGMP snooping function (V2 is fine).

By the way, the maximum power consumption is 14W for each unit.

Q3: What is the default IP address of IHD-410PT and IHD-410PR?

A:

The default IP address of IHD-410PT and IHD-410PR is B class Networking:168.254.xxx.xxx. Please set the IP address of the connected PC as static IP, such as 169.254.xxx.xxx and the sub mask as 255.255.0.0.

Q4: How to find the IHD-410PT's or IHD-410PR's IP address

A:

User is able to find the device's IP address via the monitor or Bonjour Browser.

●Via the monitor:

1. Connect HDMI monitor to the Receiver (IHD-410PR) unit's HDMI Out interface.
2. Set an identical ID number on DIP switch for all units of the same group.
3. Use Cat5e/6 cables (EIA/TIA 568B industry standard compliant) for connection between Transmitter/Receiver and the IEEE 802.3af/at PoE+ switch.
4. Apply the proper power to the Transmitter, Receiver, switch and monitor.
5. The monitor will show the information shown below.

●Via Bonjour Browser:

1. Search and download Bonjour Browser from internet.
2. Install Bonjour Browser in PC.
3. Power on IHD-410PT and IHD-410PR.
4. Connect PC, IHD-410PT and IHD-410PR in the same switch.
5. Run Bonjour Browser to find IHD-410PT and IHD-410PR.

Q5: How can I convert the video source?

A:

There are three ways to convert the video source. One is to use DIP switch, while the other two are to set VLAN port and go with HDMI splitter (matrix).

1. A Tx (transmitter) supports DIP switch for 16 channels, and every time when you convert the source, you have to switch DIP of all units to the same number.

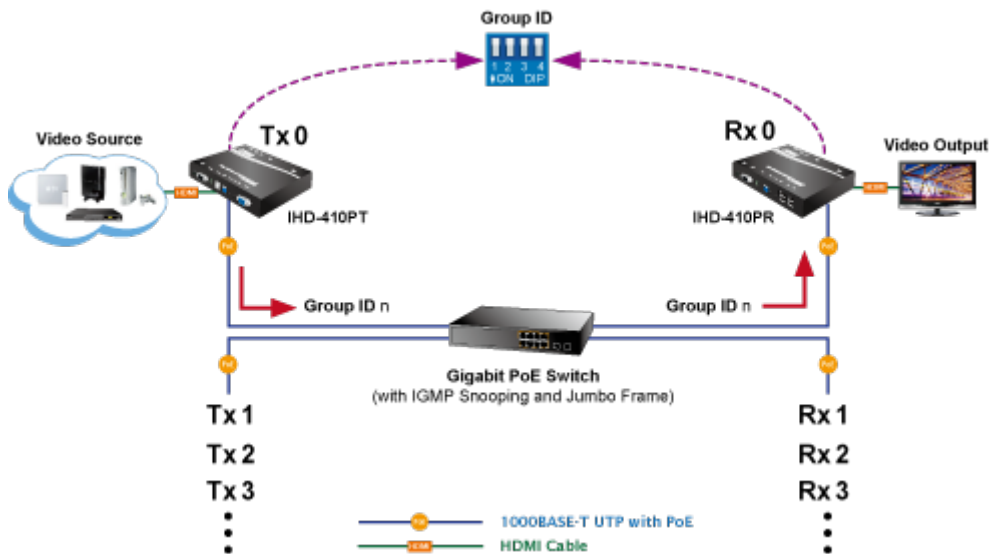

2. You can set VLAN to convert the video source. Please refer to the topology below and imagine that the concept is based on your issue.

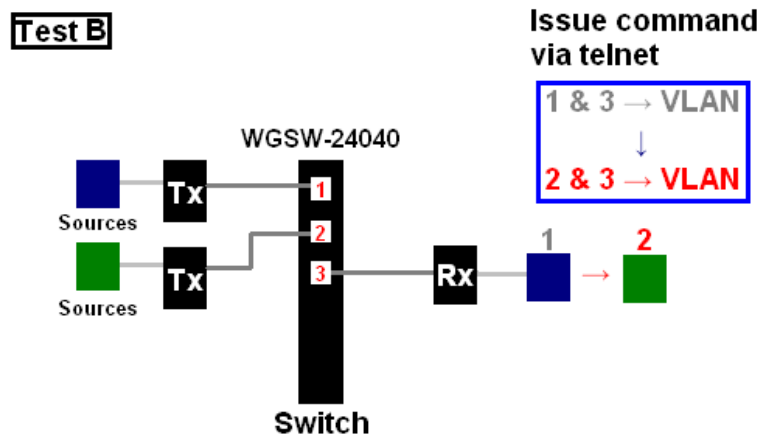
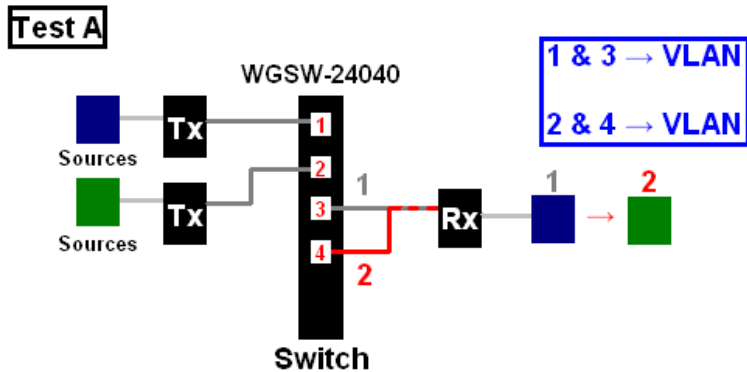

You can set port-based VLAN for the Transmitter (IHD-410PT), and then for the receiver (IHD-410PR). You can just dynamically swap the receiver port to a different VLAN for video source change. You can swap VLAN via Web interface of the switch.

Instructions about the topology above:

As for Test A, we set port1 and port3 to a VLAN, and set port2 and port4 to another VLAN. The Rx will convert the source if we change the connection of Rx and switch from port3 to port4.

As for Test B, we set port1 and port3 to a VLAN, and the Rx will convert the source if we issue the command via telnet to set port2 and port3 to a VLAN.

3. You also could use HDMI splitter (matrix) to convert the source.

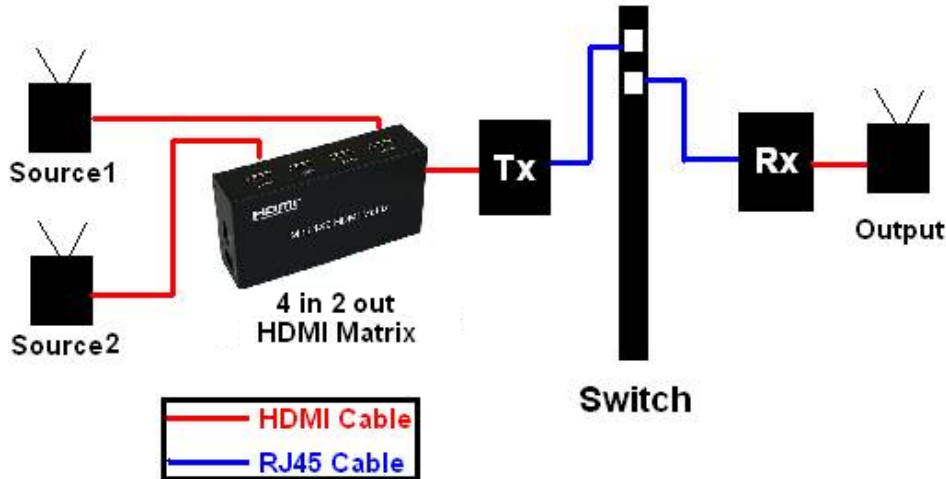

As you see, two sources connect to the input of HDMI matrix, and output to Tx, and then Tx and Rx all connect to the switch.

In this case, we use the HDMI matrix controller to select the source.

Q6: Users encounter no screen display in computer connection.

A:

1. Make sure the device cables are correctly and firmly attached.
2. Set your display device's (TV, monitor, etc.) input source as HDMI.
3. Check the PC BIOS configuration about the video output setting.
4. Connect VGA monitor to the Tx's VGA output port to check if the video signal gets through.
5. Slide the DIP Switch to the correct position.
6. Please reboot or disconnect and connect again.

Q7: Why can't the Bonjour Browser find IHD-410PT or IHD-410PR?

A:

Please check the following:

1. The PC installed Bonjour Browser is not in the same LAN as IHD-410PT or IHD-410PR.
2. The IP address of PC might be in a different subnet from IHD-410PT/IHD-410PR. Please set the PC's IP address in the same subnet as IHD-410PT/IHD-410PR.

Q8: What's the maximum limit distance between input video source and output video?

A:

The distance from the Tx to PoE switch and the distance from the Rx to PoE switch are both 100 meters. So the maximum distance between Tx and Rx is 200 meters.

Q9: What's the maximum Rx units that can be linked via one Tx unit?

A:

Video Wall: 8 x 16.

Video Extender: Theoretically, 1000 are the most, as long as each Rx unit is assigned to an IP from 65534 IP.

Q10: Why did it fail when upgrading firmware?

A:

1. The IHD-410PT has a different firmware from the IHD-410PR. Please choose the correct firmware before upgrading the firmware.
2. Do not interrupt the upgrading procedure.
3. User should upgrade the firmware to every unit. (For example, if there are 3 Rx's, user should update for 3 times.)

Q11: Why can't I send data via RS232?

A:

Please check the following:

1. The Tx and Rx should connect to each other successfully.
2. The baud rate of Tx and Rx should be the same.

Q12: How to restore IHD-410PT or IHD-410PR to factory default setting

A:

Please refer to the steps below:

1. Turn off the device first.
2. Press and hold the reset button, and then turn on the device. Keep pressing the reset button until the ACT and Link LED flash.
3. Turn off the device and back on. Once the device is operational again, it has restored to default settings.

Q13: About HDCP issue.

A:

The system will disable the video output signal when it detects non-HDCP compliant display(s) playing the HDCP video source. All the connected output displays must be HDCP compliant while the video source is HDCP compliant.

Q14: Why is 4K video source watched on a non 4K monitor so blur or choppy?

A:

We suggest user do not use the low-resolution monitor to watch the higher quality video source. The screen resolution can only be backward compatible, not forward compatible. So please adjust the video source resolution appropriate for the output screen resolution.

Q15: How to use IR extension on IHD-410PT and IHD-410PR?

A:

Please refer to the steps below:

1. Connect the IR emitter cable to IHD-410PT, and make IR emitter cable focus to video source device.
2. Connect the IR receiver cable to IHD-410PR.
3. Power on IHD-410PT and IHD-410PR.
4. Make them connect to each other.
5. Use the remote controller of video source device to control video source device via IR receiver cable.

Q16: Do I have to use the same screen resolution to set video wall?

A:

We suggest user to use the same screen resolution to set video wall so that user can get the best performance.

Q17: How can I connect one video source to two or more Tx ?

A:
It is recommended to use HDMI splitter with two or more ports.

Q18: The output monitor which is connecting to IHD-410PR does not display any video or show wrong color video. How can I fix it?

A:
The IHD-410PR might not copy correct EDID. Please refer to the following:
1. The output monitor should be a real HDMI monitor; do not use DVI-to-HDMI or any converter. EDID is important for it contains information about manufacturer name and serial number, product type, maximum image size, color characteristics, factory pre-set timings, frequency range limits, etc. In some cases display problems may occur due to the incorrect EDID communication between the display monitor and the unit or inappropriate EDID data programmed by display manufacturers. Therefore, by adopting the “EDID COPY” function, it will allow the system to copy EDID information from EDID compliant displays in order to assure accurate display performance.

However, owing to various monitor models, EDID data may not be usable to all. For example, if you use a DVI-to-HDMI converter to a real DVI monitor, the copied EDID (HDMI) data may not be applicable to DVI monitors.

2. Please get into the IHD-410PR’s web management to copy EDID manually.

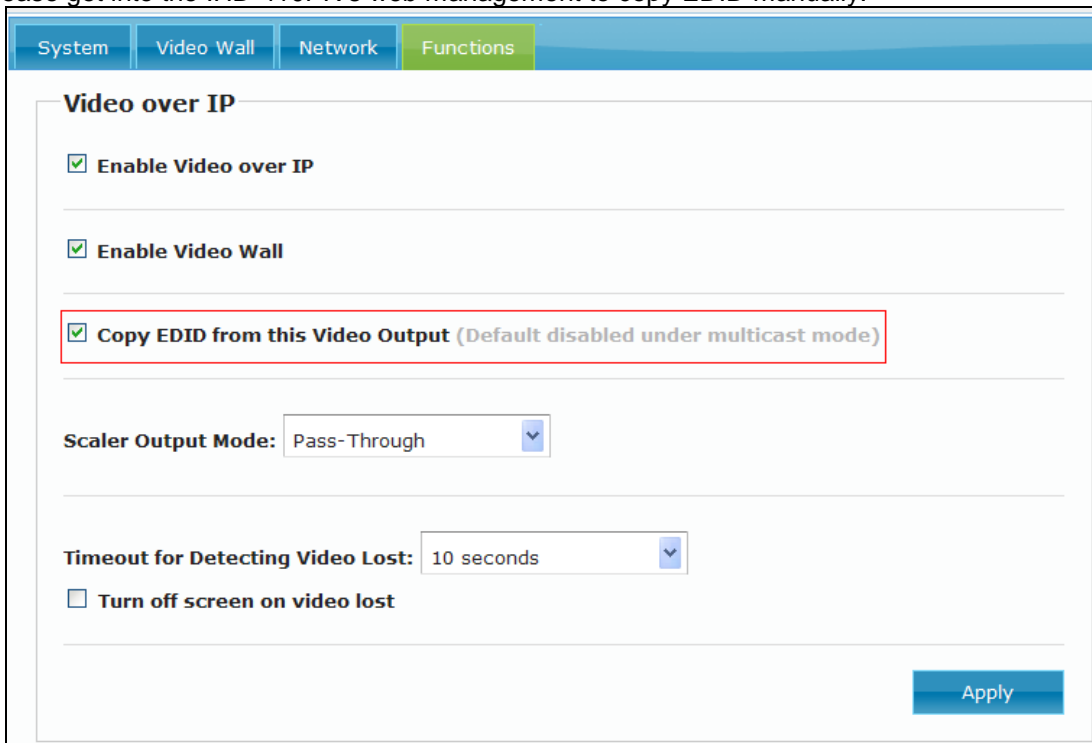

Q19: What is the difference between Graphic Mode and Video Mode?

A:
By default, the Video Mode is selected.

Graphic Mode: It’s usually for the static state video. Pictures are the main display contents, and the pixel update processing is not so fast. The CPU consumption is lower than video mode.

Video Mode: It’s usually for the dynamic state video. Videos are the main display contents, and the pixel update processing is fast. The CPU consumption is higher than graphic mode.

Q20: Please specify the traffic bandwidth based on one pair of IHD-410PT and IHD-410PR stream.

A:

There are too many factors that are able to affect the bandwidth and compression ratio that depends on your video format, resolution, etc.

For your reference, when user plays a 4K@30Hz video with IHD-410PT and IHD-410PR, the maximum bandwidth is around 850Mbps; the average bandwidth is around 275Mbps (If the video quality source is higher, it will request higher bandwidth.).