



Jabra Vision User Guide

Version 2.4.1.1

- 1. Jabra Vision overview 3
- 2. Jabra Vision requirements and limitations 5
- 3. Download and installation 6
- 4. Whiteboard 8
 - 4.1 HQ Whiteboard Only vs Video + Whiteboard
 - 4.2 How to set up your whiteboard
 - 4.3 How to share your whiteboard
 - 4.4 How to adjust your whiteboard image
 - 4.5 How to save whiteboard image
 - 4.6 How to save whiteboard preset
 - 4.7 Using the Camera mode
 - 4.8 Using the video preview window
- 5. Tips and best practices for whiteboard 22
- 6. Use Jabra Vision to control your Jabra PanaCast..... 25
 - 6.1 PTZ Controls
 - 6.2 Color Controls
 - 6.3 Settings
 - 6.4 Help
- 7. How to check the Jabra Vision version 27
- 8. Having trouble connecting the camera?..... 28

1. Jabra Vision overview

Jabra Vision is a virtual camera application. It allows you to control your local real-time video stream of Jabra PanaCast. This guide explains how to use the Jabra Vision application and Whiteboard feature for Windows OS.

- Whiteboard

The Whiteboard feature allows you to share a physical whiteboard in a conference room or classroom with remote participants through video conferencing apps. This Whiteboard application offers following features:

- Maximum video resolution: 1920 x 1080
- Compatible with all major video conferencing applications, such as Microsoft Teams, Zoom, Cisco WebEx Teams, Google Meet, GoToMeeting and more (not supported in Microsoft Team Rooms or Zoom Rooms environments)
- Ability to capture whiteboard (or a region) visible in the 180° Field of View
- Ability to save up to three presets

- Advanced Intelligent Zoom

Convolutional Neural Networks (CNN) based Intelligent Zoom capability can detect people presence up to 10.7m / 35 ft from the camera and automatically adjust the field of view to include everyone in the conversation.

- PTZ Controls to adjust Pan-Tilt-Zoom of live video stream and save up to three presets
- Color controls allow adjusting of image attributes for the following:
 - Brightness
 - Contrast
 - Saturation
 - Sharpness
 - White balance

- Settings allow control of general settings for the Jabra Vision, such as application startup behavior and the associated features and functionality.
- Help allows users to access the Jabra Support Page with one click.

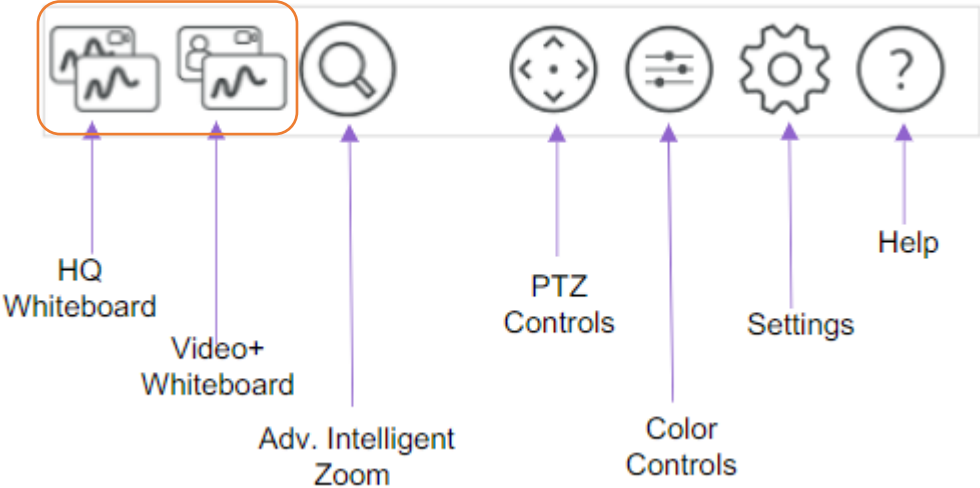

Note: The Advanced Intelligent Zoom icon is only visible in the Video + Whiteboard mode when Advanced IZ function is enabled in Settings.

2. Jabra Vision requirements and limitations

Hardware and Software Requirements

- Jabra PanaCast camera with Firmware 3.8.15 or later
- Windows 8.1 (64-bit) or Windows 10 (64-bit)
- Dual Core i5 Gen 5 or higher
- 8GB RAM

Limitations and Restrictions

- Available only for Windows platforms (Mac OS, Chrome and Linux are not currently supported).
- For best results of whiteboard capture, the distance between camera and whiteboard should:
 - not exceed 3.5m / 11.5ft for **HQ Whiteboard** mode
 - not exceed 2.5m / 8ft for **Video + Whiteboard** mode
- Whiteboard should be parallel to the wall. Whiteboard at an angle to the ground will adversely affect the whiteboard capture (Please see Section 5 for Tips and Best Practices).

3. Download and installation

1. **Download Jabra Vision.** Use the link to download JabraVisionInstaller from Jabra website: jabra.com/panacast

WINPeopleCountApp.v2.3.0_VS2017	10/29/2020 3:07 PM	Compressed (zipp...	7,951 KB
JabraVisionInstaller_2_4_1_0	11/23/2020 1:20 PM	Application	172,158 KB

2. **Install Jabra Vision.** Launch the downloaded JabraVisionInstaller executable file and follow the onscreen instructions.

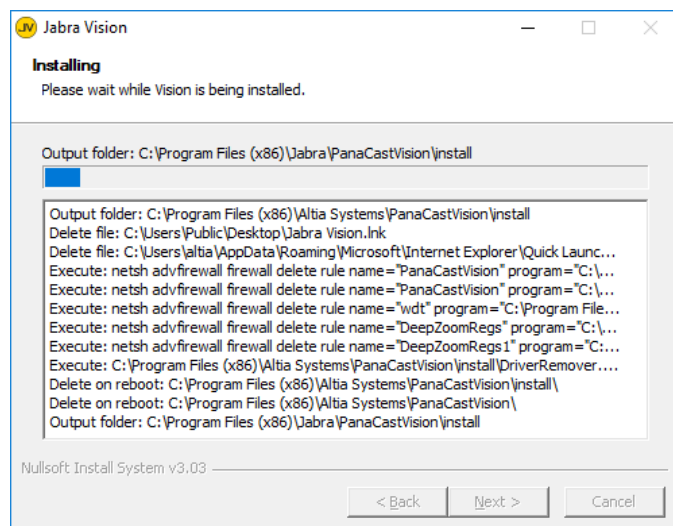
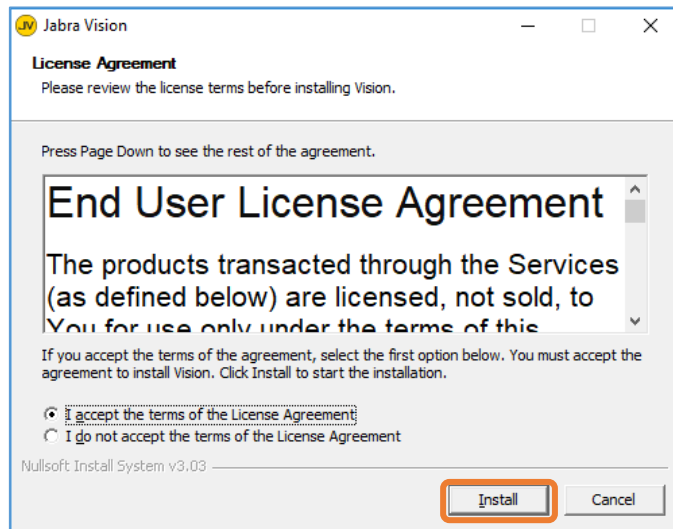

In case the PC does not have the latest Windows updates applied, the installation process may prompt the user to install the necessary Microsoft .net framework files. Please download the files when prompted and the installation process will continue.

Once the installation has completed, the application will show the following message. Click on Finish which will automatically launch the application.

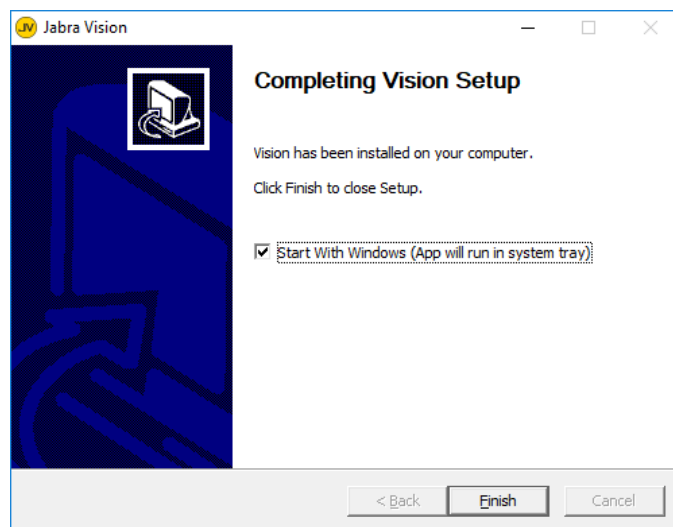

- Update Jabra Vision.** Upon launch, the Jabra Vision application automatically checks for new updates. Click Update Now to immediately update, otherwise, click Update Later to update the application later.

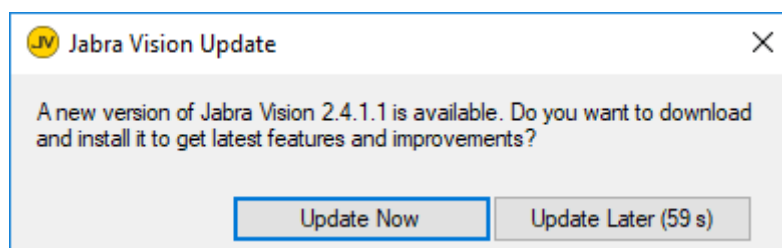

4. Whiteboard

The Whiteboard feature allows you to use an existing whiteboard in a conference room or classroom to easily share content with remote participants through video conferencing apps.

The Jabra Vision application extracts the defined region, orthogonally corrects it to rectify distortion and presents it in a shareable content window, which can then be shared using the “Share” feature of your selected Unified Communications (UC) or Video Conference (VC) application, such as Microsoft Teams, Zoom and more.

To implement Whiteboard, you need the Jabra PanaCast device and Jabra Vision application, along with your whiteboard and Windows device.

4.1 HQ Whiteboard Only vs Video + Whiteboard

The Whiteboard feature is available in two different modes: HQ Whiteboard Only and Video + Whiteboard. You can choose the Whiteboard mode that fits best for your setup.

- **HQ Whiteboard Only** offers 1080p real time video from a single camera (left, center or right). In this mode, you can capture your whiteboard with high quality image, but remote participants will only see the whiteboard view. Use the HQ Whiteboard Only mode if your whiteboard is 2.5-3.5m / 8-11.5ft away from Jabra PanaCast and your whiteboard selected area is within a single sensor view.

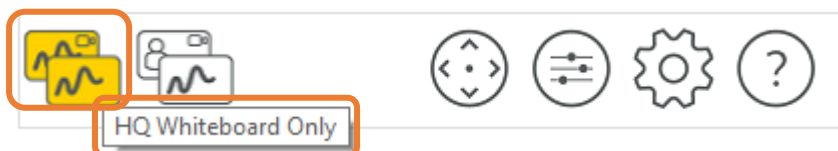

- **Video + Whiteboard** offers 720p real time video over the full 180° field of view. In this mode, remote participants can see your video and the whiteboard view at the

same time. Use the Video + Whiteboard mode if your whiteboard is within 2.5m / 8ft from Jabra PanaCast.

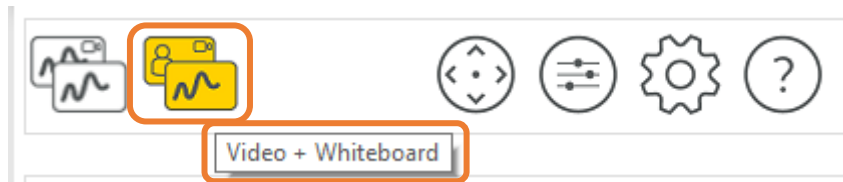

Note: Highlighted icon shows the feature is active.

Whiteboard Mode	HQ Whiteboard Only	Video + Whiteboard
Camera distance from whiteboard	Up to 3.5m / 11.5ft	Up to 2.5m / 8ft
Shareable Content Image Quality	High (1080p)	Good (720p)
During WB Sharing, Remote Attendees will see	Whiteboard Only	Video and Whiteboard

You can use the Whiteboard feature with different types of (white)board including:

- Traditional blackboards
- Traditional whiteboards
 - White polished whiteboards with black markers provide the best writing visibility experience.
- Glass whiteboards
 - Glass whiteboards have depth and can cause a shadow effect. Additionally, glass is a highly reflective surface and can adversely affect visibility. It is recommended to fine-tune your setting through adjusting the height of the camera and reducing the brightness level through the Jabra Vision application to minimize reflections. Keeping the height of the camera level with the center of the whiteboard helps minimize the shadow effect and improve readability.
- Interactive whiteboards or smartboards
- Region of wall or any other well lit defined region
- Whiteboard size: from 1m x 1.5m to 1.5m x 3m / from 3ft x 5ft to 5ft x 10ft

4.2 How to set up your whiteboard

Before you launch the Whiteboard feature ensure that Jabra PanaCast is connected to your PC and you can see the live video in the Jabra Vision preview window.

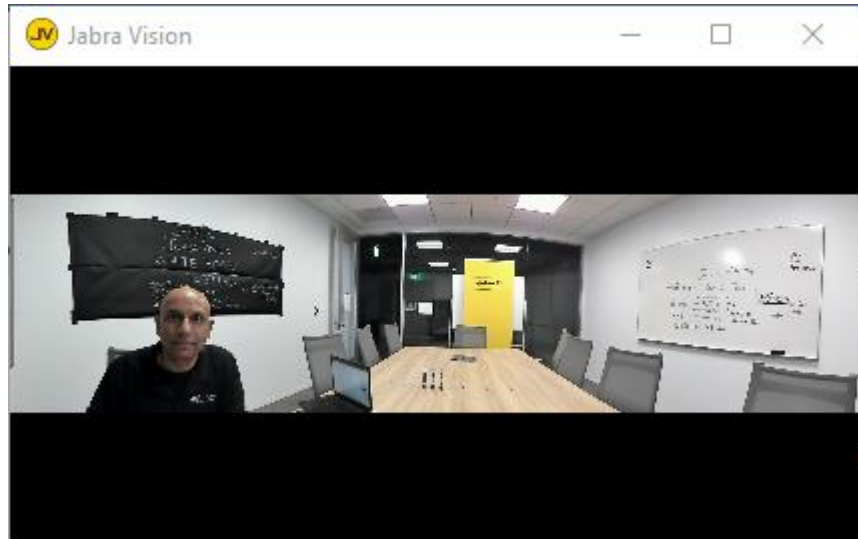







Depending on your requirements and needs, you can launch the Whiteboard feature by clicking on either the HQ Whiteboard Only or Video + Whiteboard icon.

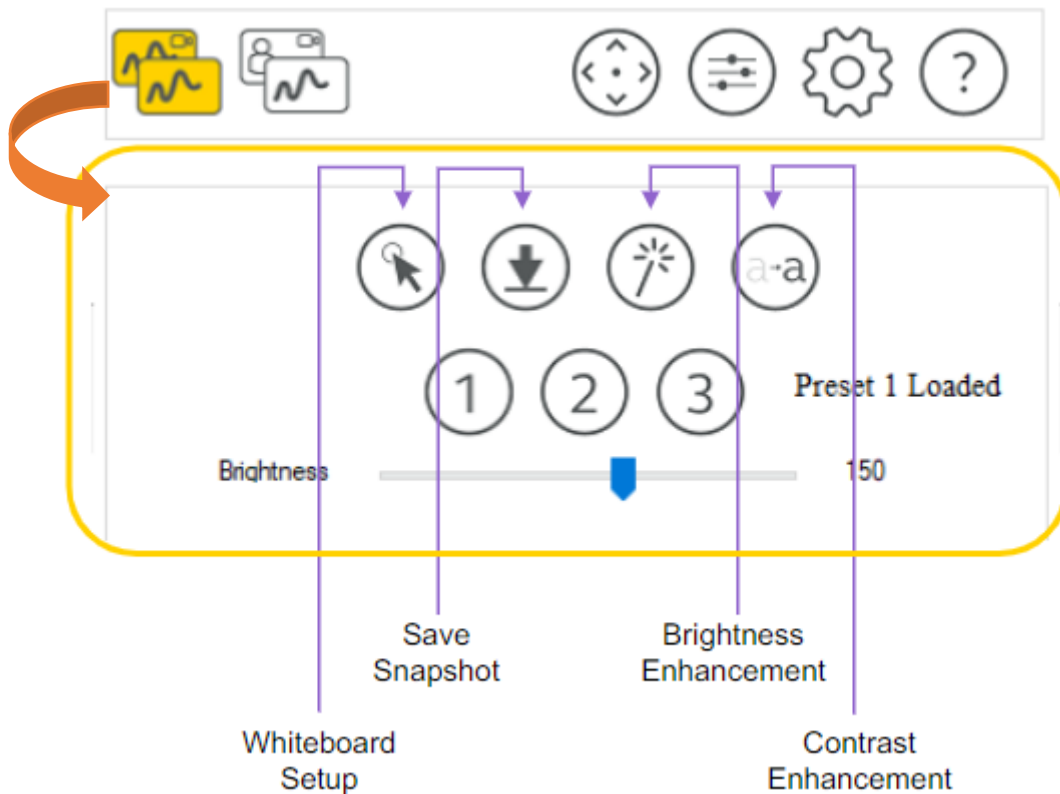

For HQ Whiteboard Only mode

1. Click on the HQ Whiteboard Only button . The icon will highlight indicating that the feature is now active, and you will see the controls as shown below.



-  HQ Whiteboard Only – single camera mode with high quality whiteboard view
-  Manually select your whiteboard
-  Save snapshots to the location provided in the Settings window.
-  Brightness Enhancement
-  Contrast Enhancement
-  Save presets (click and hold the preset button for 5 seconds to save the position)

2. When you install the Jabra Vision and launch the Jabra Whiteboard feature for the first time, a Whiteboard Setup window will appear. Select 4 corners (clockwise) to define your whiteboard region.

If you need to redefine your whiteboard or select a new region, click on button to redefine the whiteboard region. It will take a snapshot of the room where you can define the desired region as shown below.

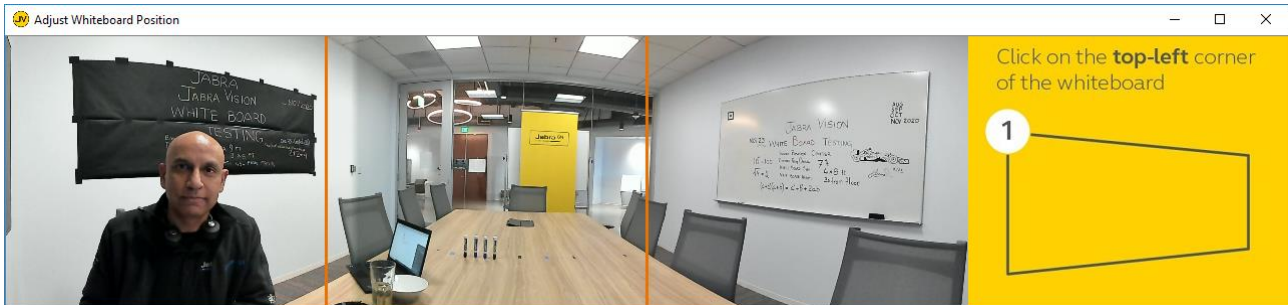

3. Follow the instruction on the right-hand side to setup the whiteboard region

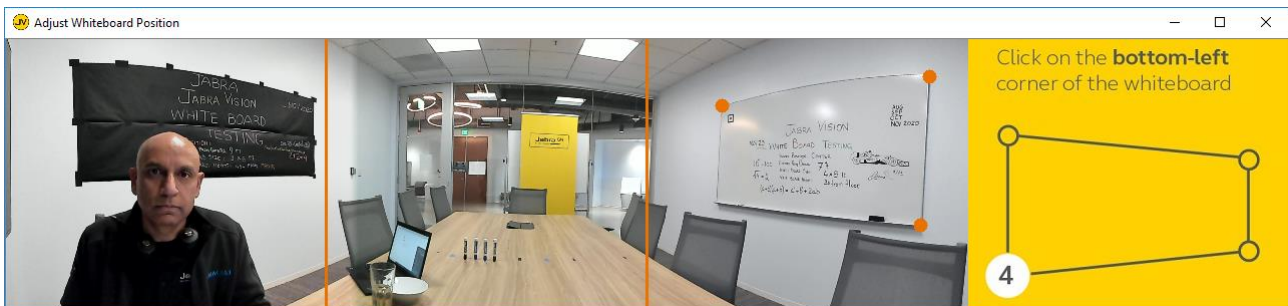
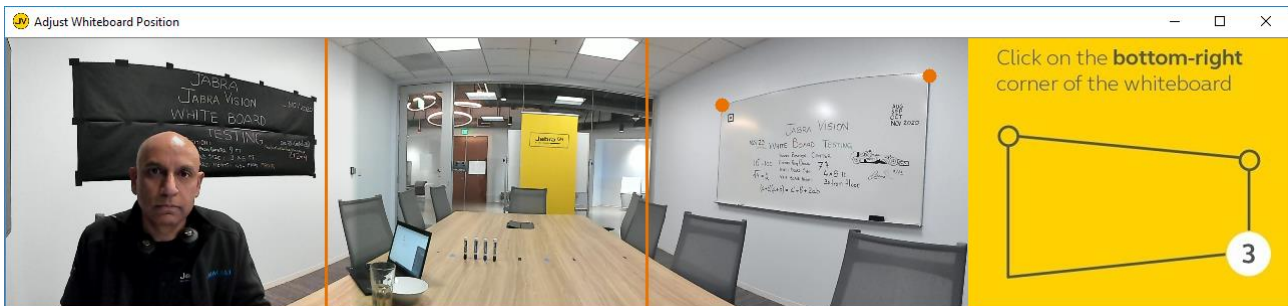
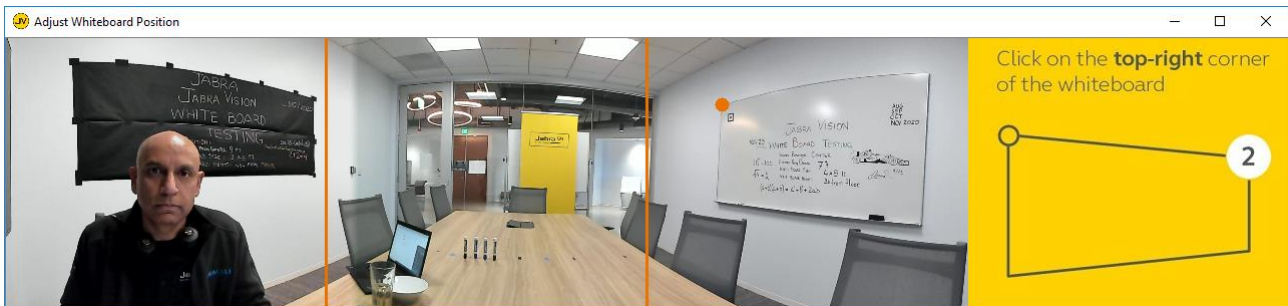

Note: Each region is separated by lines representing the field of view covered by each of the 3 cameras on the Jabra PanaCast. Ensure that all 4 corners of the selected region are within a single designated region for one of the cameras in order to maintain a HQ Whiteboard capture.

- Once you define all 4 corners of the whiteboard, the Jabra Vision application will extract the region in a shareable content window as shown below.

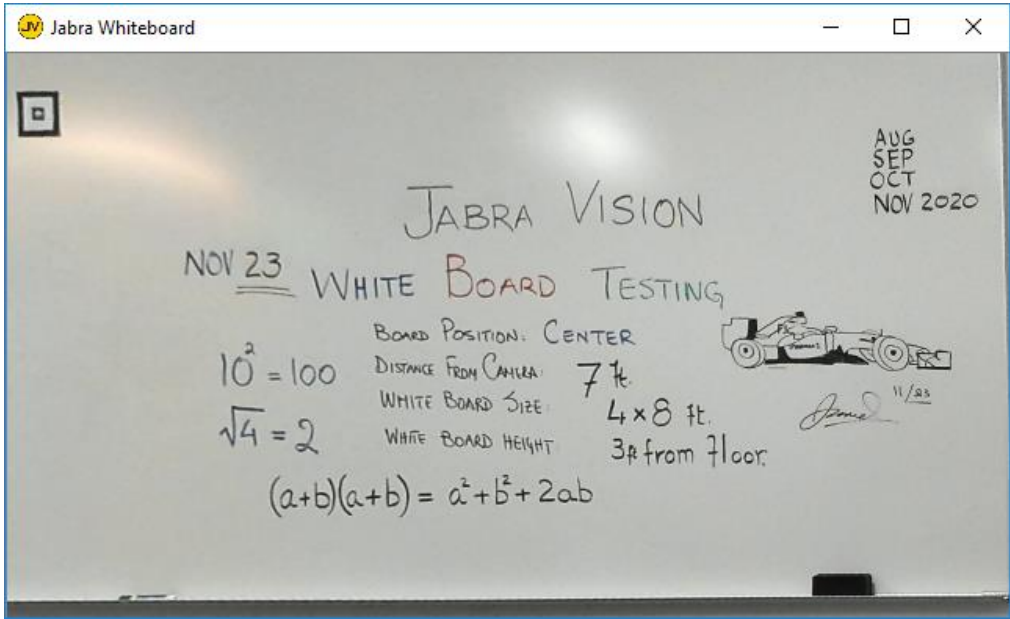





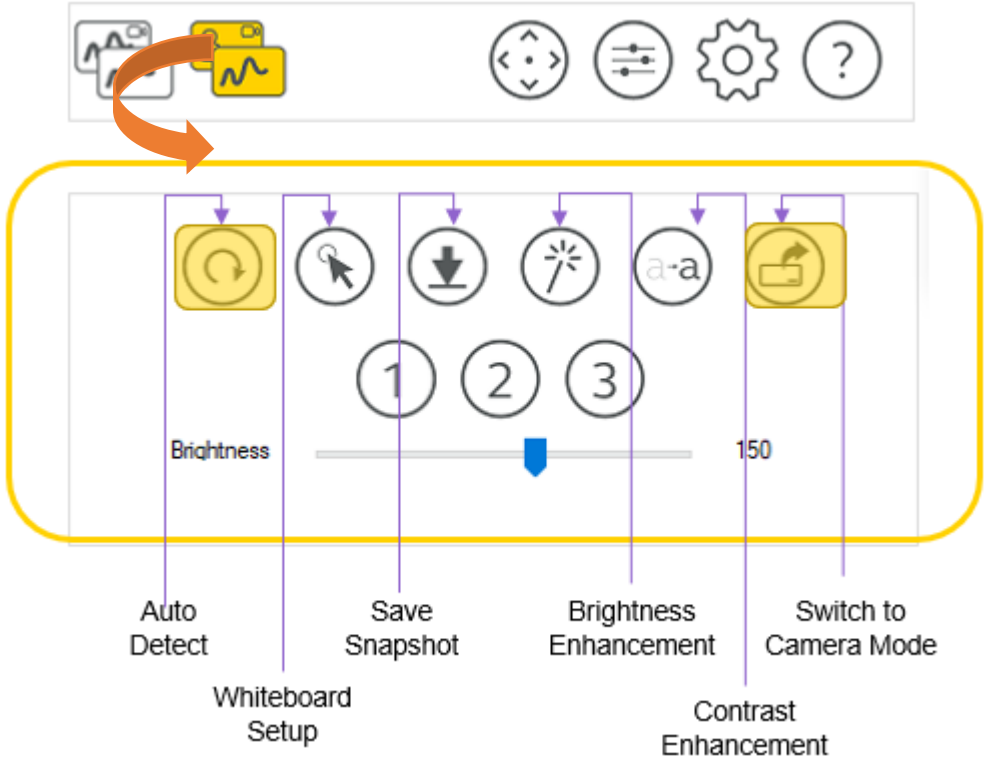

For Video + Whiteboard mode

- Click on the Video + Whiteboard button . The icon will get highlighted and the feature becomes active. It opens another set of controls as shown below.



Note: Auto Detect feature is not currently available

-  Video + Whiteboard – multi-camera view with content share capability
-  Manually select your whiteboard
-  Save snapshots to the location provided in Settings Window
-  Brightness Enhancement
-  Contrast Enhancement
-  Switch to Camera mode (available in the Video + Whiteboard mode only)
- ① ② ③ Save presets (click and hold the preset button for 5 seconds to save the position)

2. When you install the Jabra Vision and launch the Jabra Whiteboard feature for the first time, a Whiteboard Setup window will appear. Select 4 corners (clockwise) to define your whiteboard region.

If you need to redefine your whiteboard or select a new region, click on  button that allows you to redefine the whiteboard region. It will take a snapshot of the room where you can define the region desired as shown below.

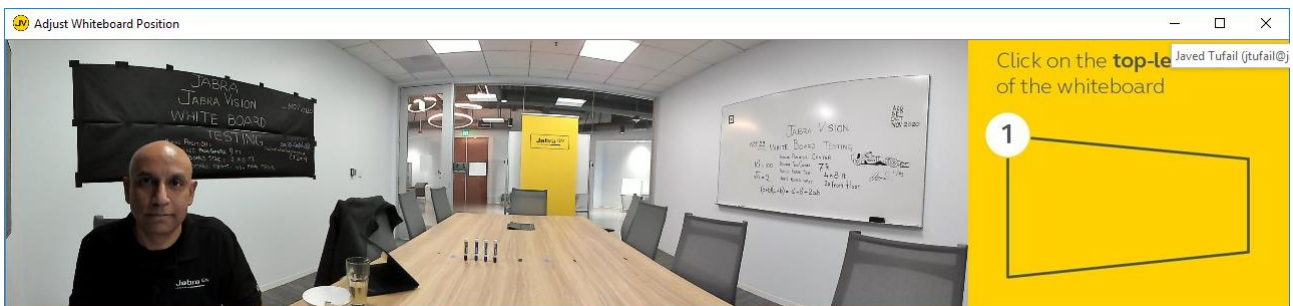

3. Follow the instruction on the right-hand side to setup the whiteboard region

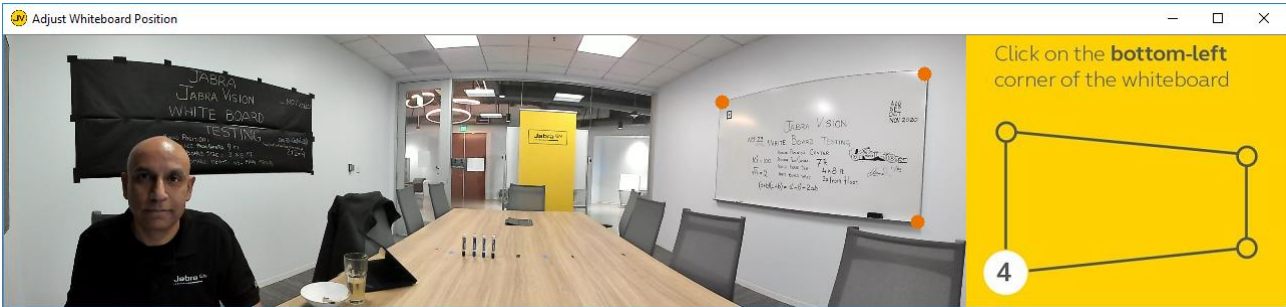
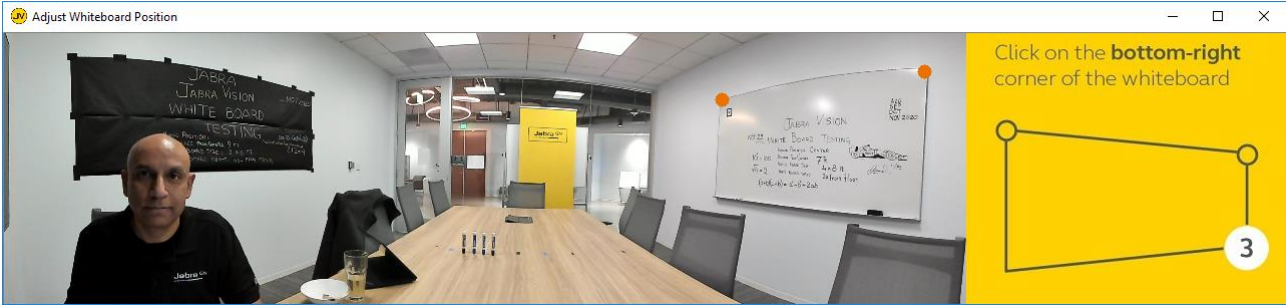
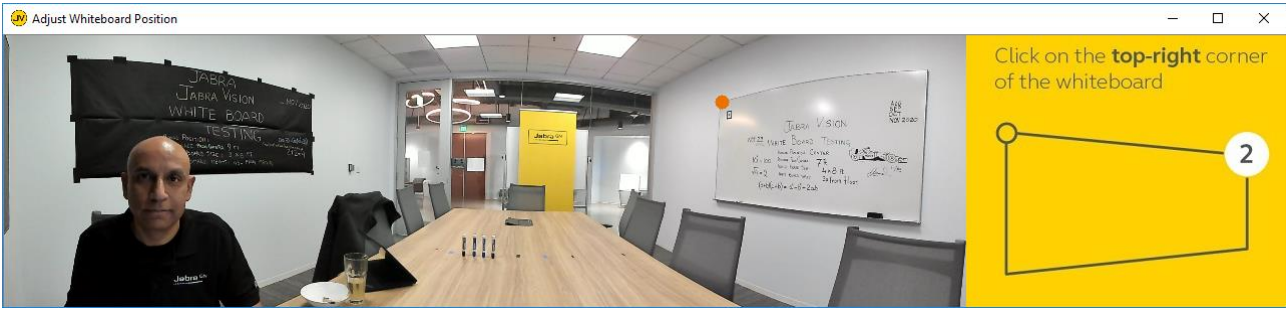

- Once you have defined all 4 corners of the whiteboard, the application will extract and region in a shareable content window.

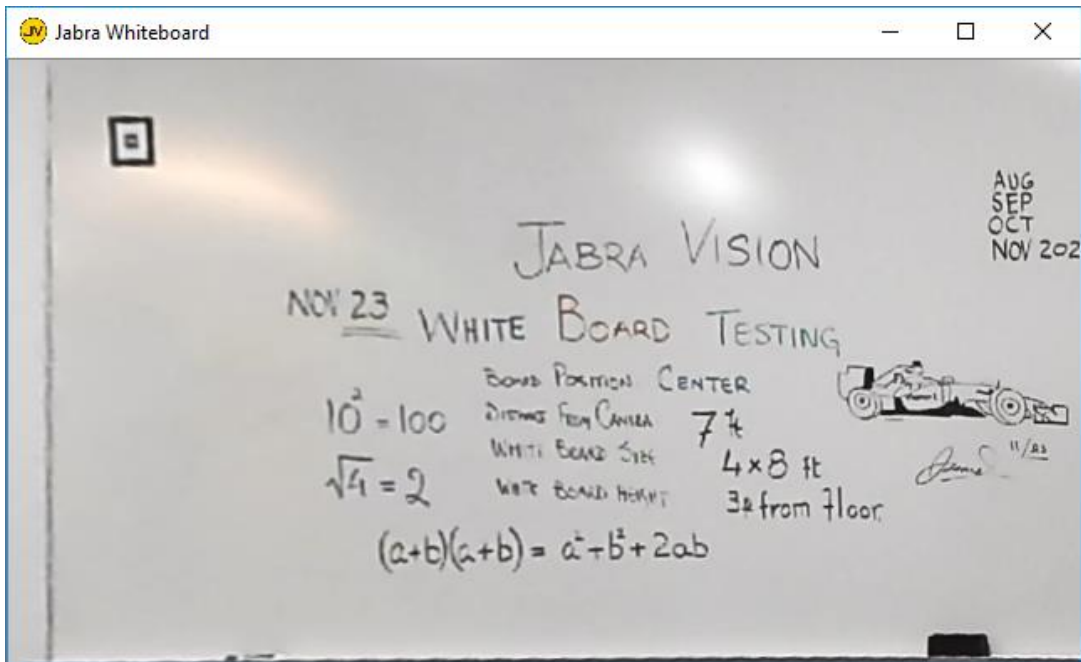

4.3 How to share your whiteboard

Use the “Share” feature in your selected UC / VC application (Microsoft Teams, Zoom, Google Meet etc.) and choose the “Jabra Whiteboard” to share it with your remote attendees.

With Microsoft Teams

- Launch **Microsoft Teams** and start a Teams meeting
- Select **Jabra Vision** as your camera
- Select Share  in your meeting controls
- Choose the **Jabra Whiteboard** window to share

With Zoom

- Launch **Zoom** and start a Zoom meeting
- Select **Jabra Vision** as your camera
- Select Share Screen  in your meeting controls
- Choose the **Jabra Whiteboard** window to share

4.4 How to adjust your whiteboard image

Brightness Enhancement: To enhance brightness click on the Brightness Enhancement button.

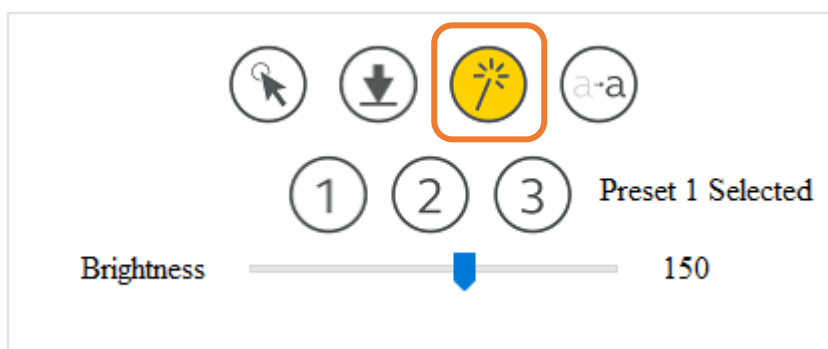

The Brightness Level is immediately adjusted

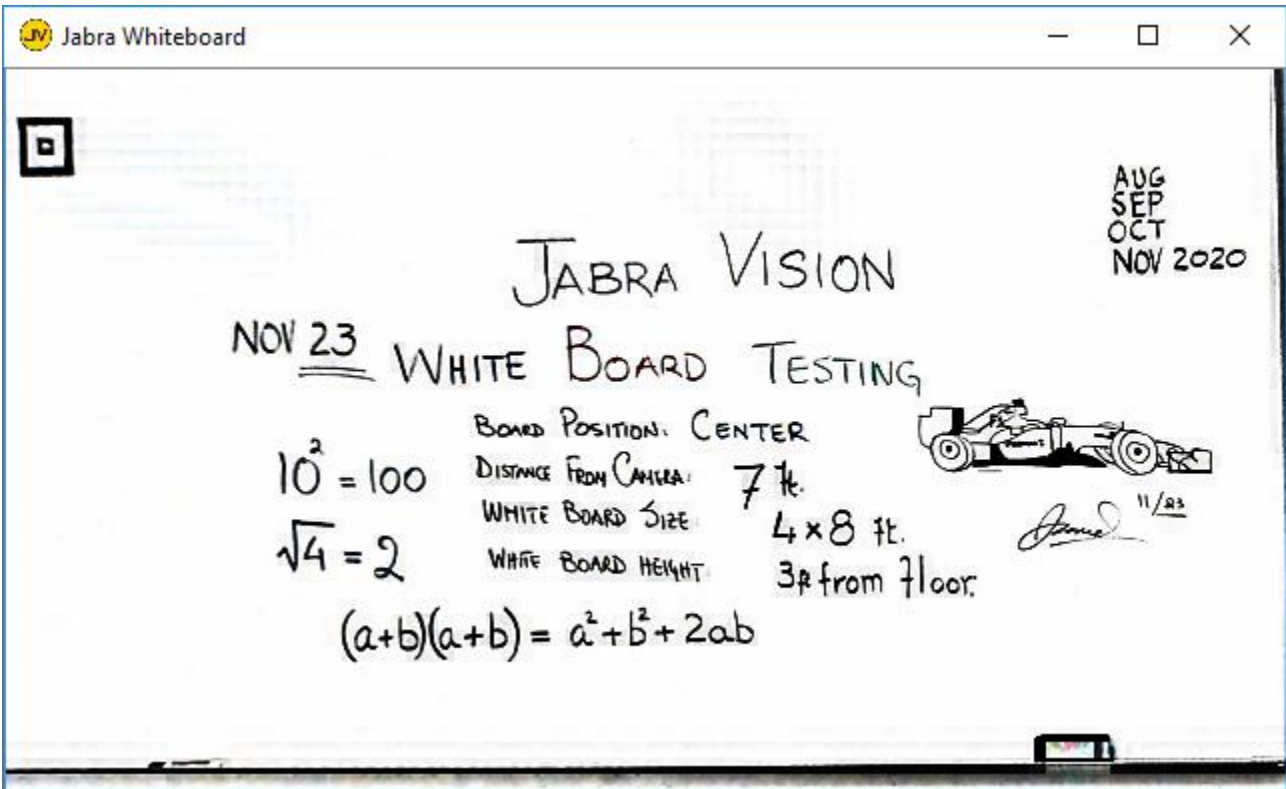

Contrast Enhancement: To enhance contrast level click on the Contrast Enhancement button.

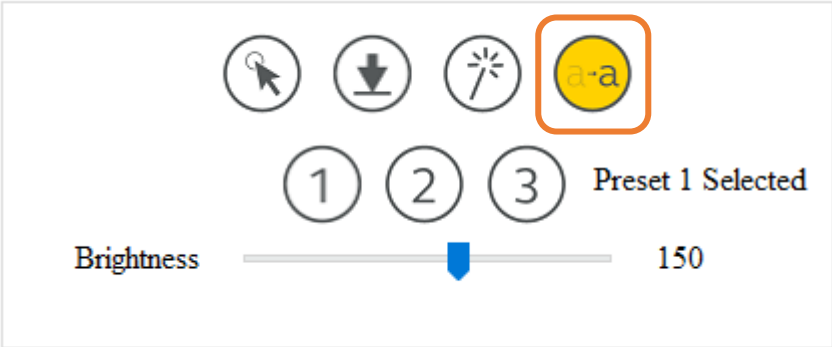

The Contrast Level is immediately adjusted

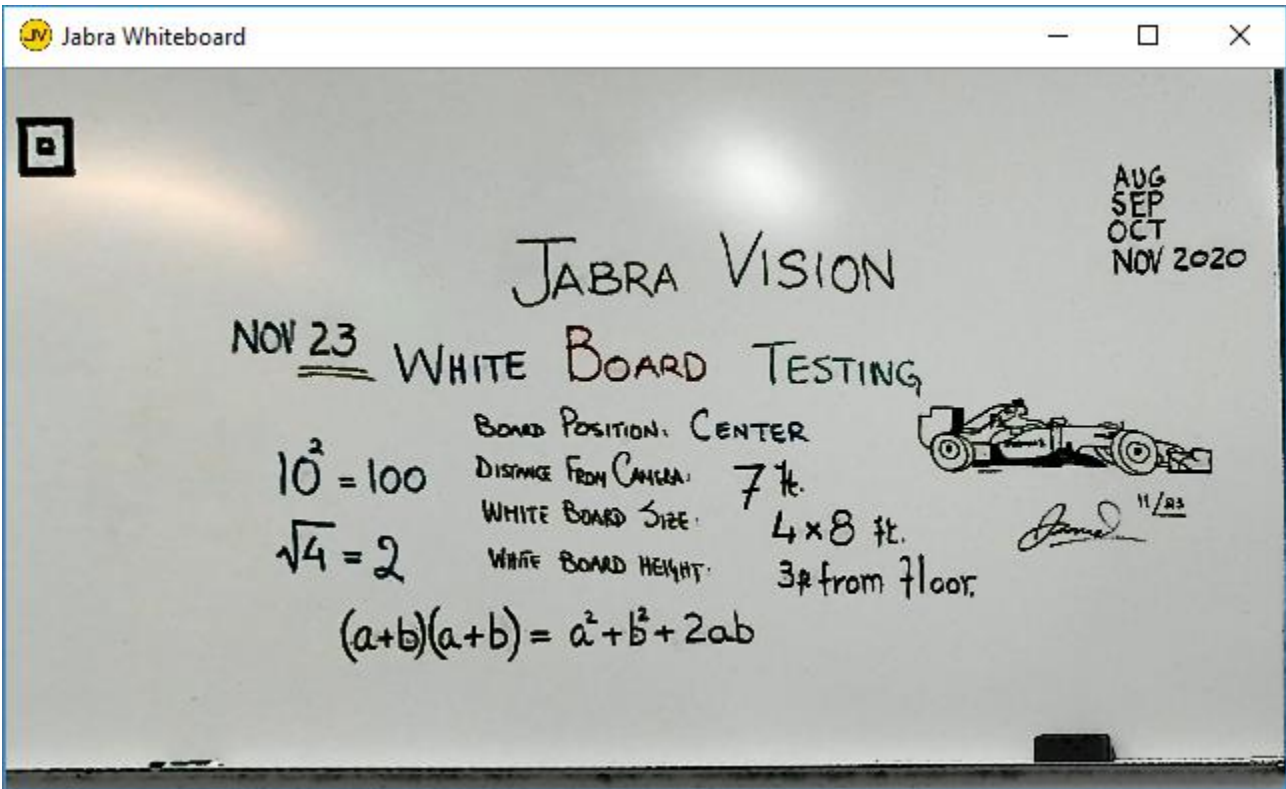

Brightness adjustment: to manually adjust brightness using the Brightness slider bar at the bottom of the controls.



4.5 How to save whiteboard image

Click on the **Save Snapshot** button to save the image of the whiteboard shareable content window in the selected folder. The default location is

C:\ProgramData\PanaCast Vision

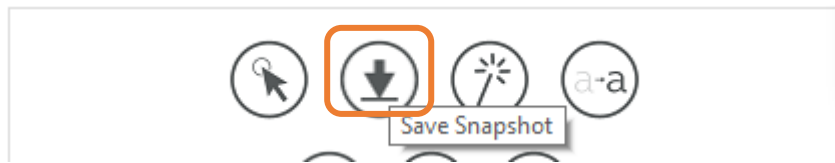

4.6 How to save whiteboard preset

You can save up to three **whiteboard presets**. Once a whiteboard has been defined click on a preset button and keep it pressed for 5 seconds to store the preset.



To save additional presets, define new regions and save the presets as described above.

Preset messages are as follows:

- Preset # Loaded – when the application loads a pre-defined preset
- Preset # Saved – when a present is saved
- Preset # Not Defined – when no preset has been defined
- Preset # Selected – when a preset is selected to be loaded

4.7 Using the Camera mode

Camera mode (only available in the Video + Whiteboard mode) allows users to convert the shareable content window into a real time video stream. Use the streaming whiteboard image to replace your video. The benefit of this mode is you can stream your whiteboard as live video and share your slides (or any other application) as shareable content, vacated by Jabra Whiteboard. The Camera mode is a toggle button to turn it on or off.

When the Camera mode is turned on the Jabra Whiteboard shareable content window will disappear with a Tool Tip Message as shown below:

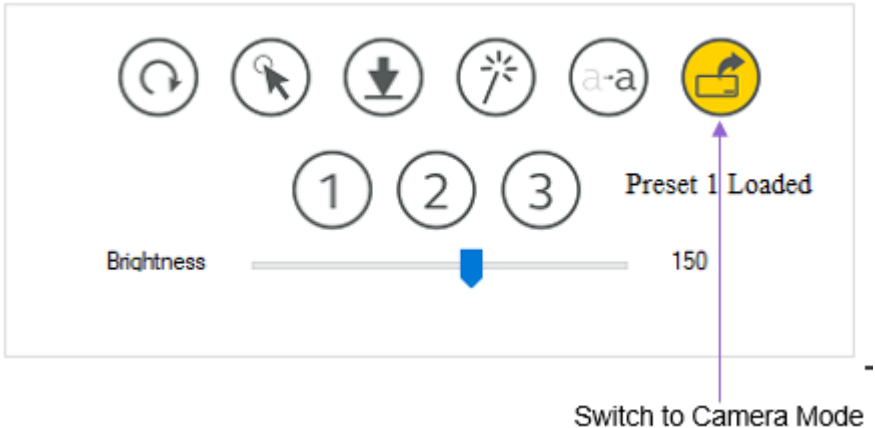

4.8 Using the video preview window

The **Video Preview Window** allow users to preview their video before joining the call using Jabra Vision as their virtual camera. The view in the Video Preview Window changes when the Whiteboard is launched and depends on whether the user is on an active call or just testing/setting up their whiteboard.

Active Call: When the Whiteboard feature is launched during an active call, the Jabra Vision application freezes the video in the preview video. However, the remote site is still receiving the live video at their end.

HQ Whiteboard Only Mode:

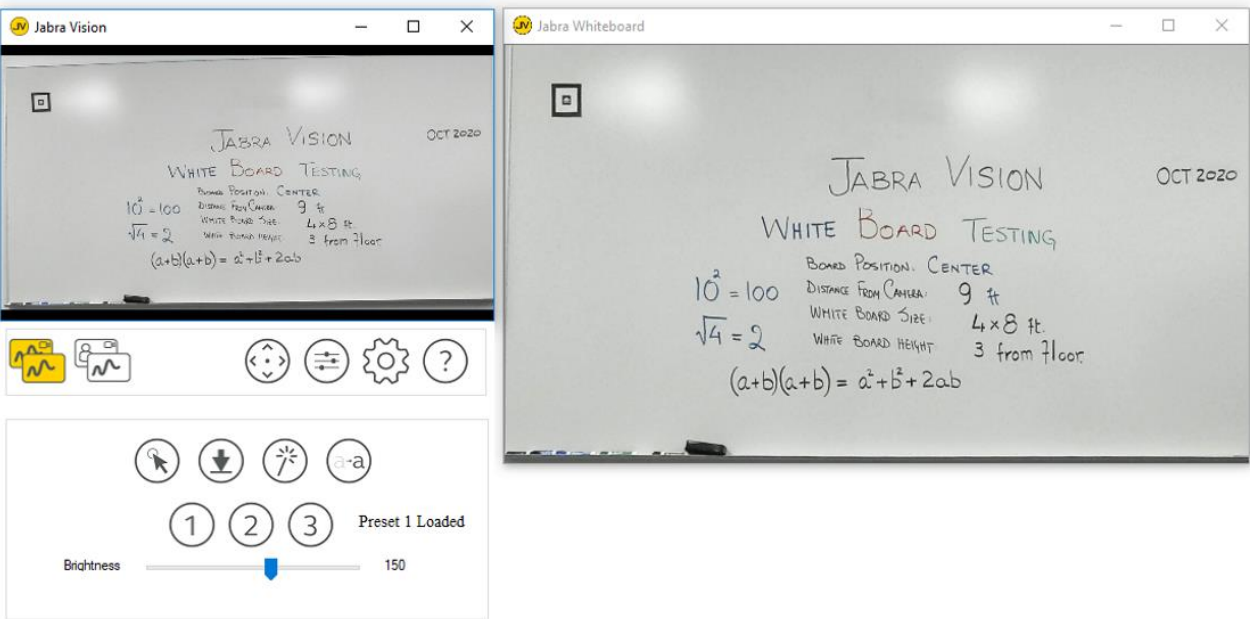

Remote attendees will see the Whiteboard as the real time video without perspective correction, the user can share the Jabra Vision Whiteboard with remote attendees as shareable content.

Video + Whiteboard Mode:

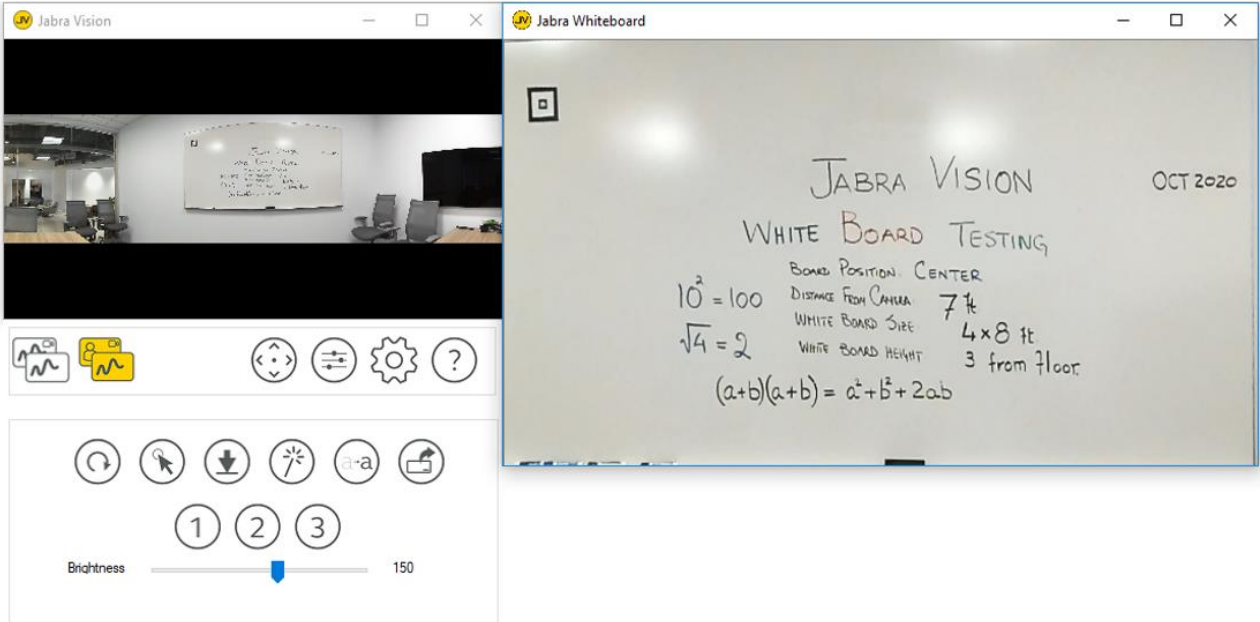

Remote attendees will continue to see the real time video when the user turns on Video + Whiteboard mode. The user can share the Jabra Vision Whiteboard with remote attendees as shareable content.

5. Tips and best practices for whiteboard

- The Jabra Vision Whiteboard feature is capable of capturing whiteboards at acute angles as shown below:

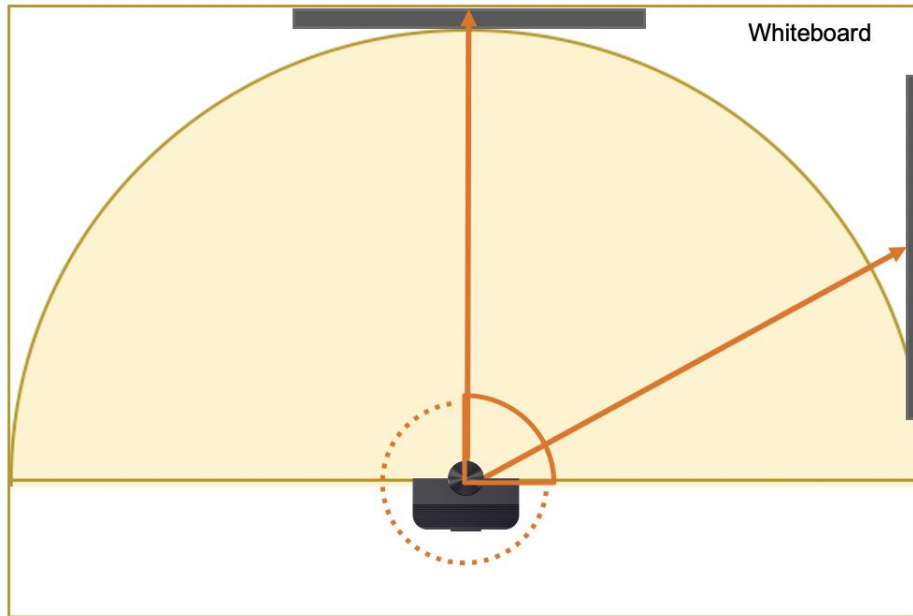

- For best results the Jabra PanaCast should be at 90° to the Whiteboard surface. The Jabra Vision application is able to capture a whiteboard even when the line of sight of Jabra PanaCast camera and Whiteboard surface are parallel to each other as shown below:

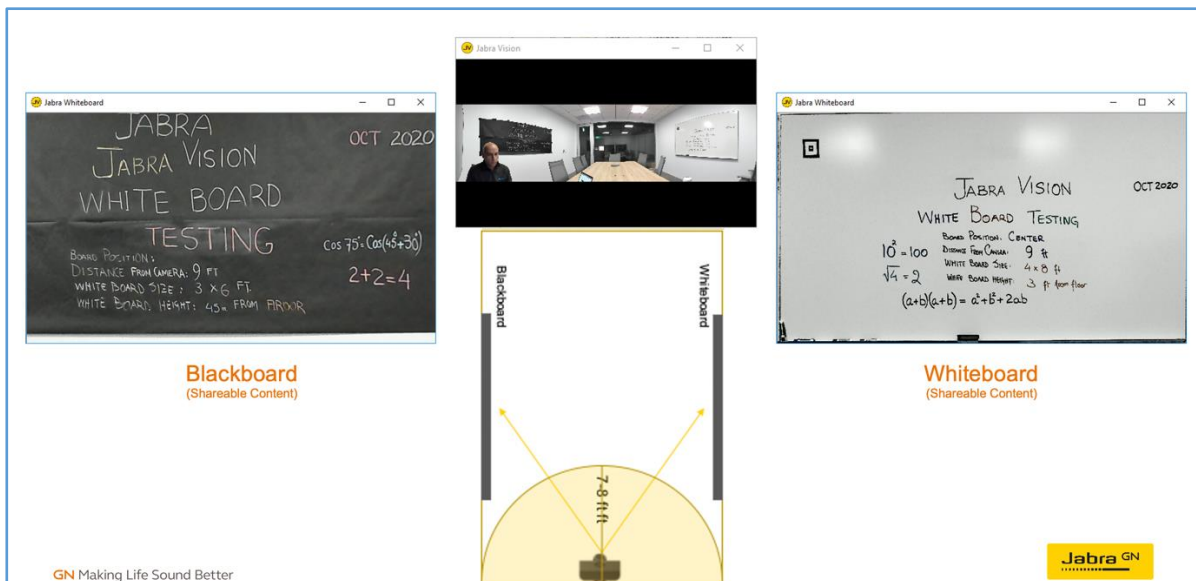

- You may see a slight difference in resolution depending on the acuteness of the angle. Therefore, best results are achieved when the angle between the camera and the whiteboard is between 45° to 90°.

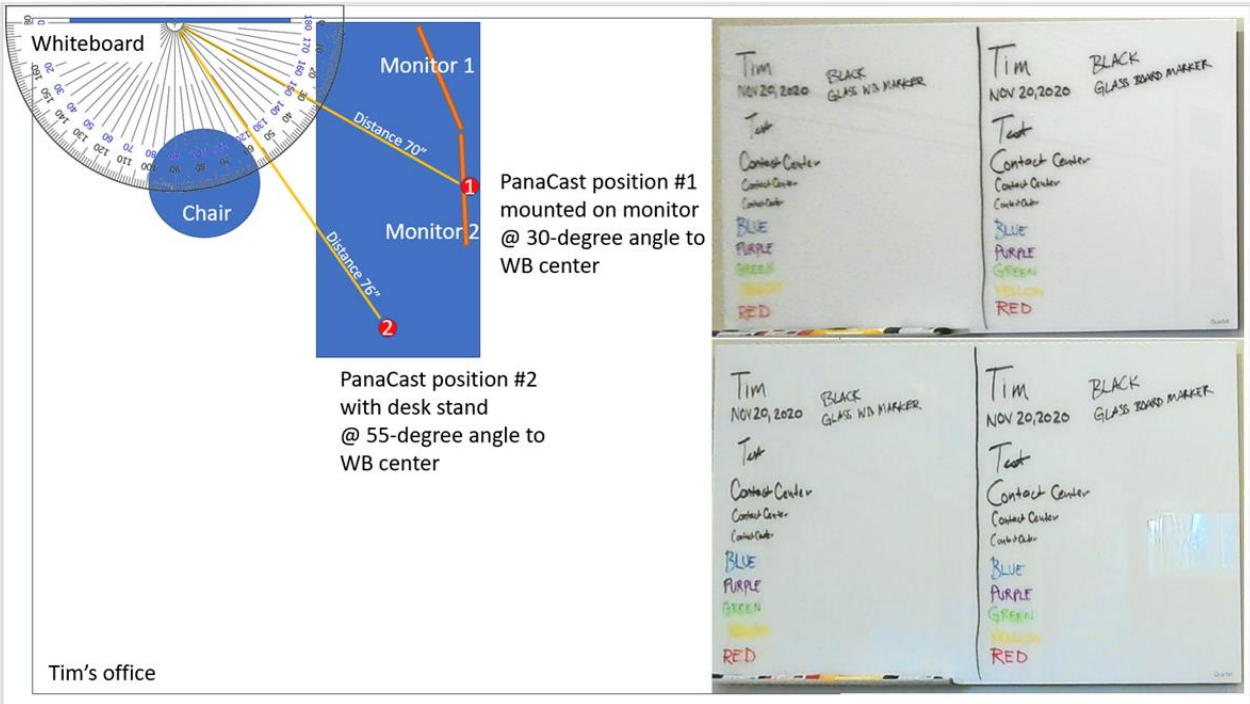

- For best results use black markers. Some color markers are difficult to read.
- Glass surface whiteboards have depth and can cause shadow effect, therefore for best results the center of camera should be level with the center of the whiteboard.

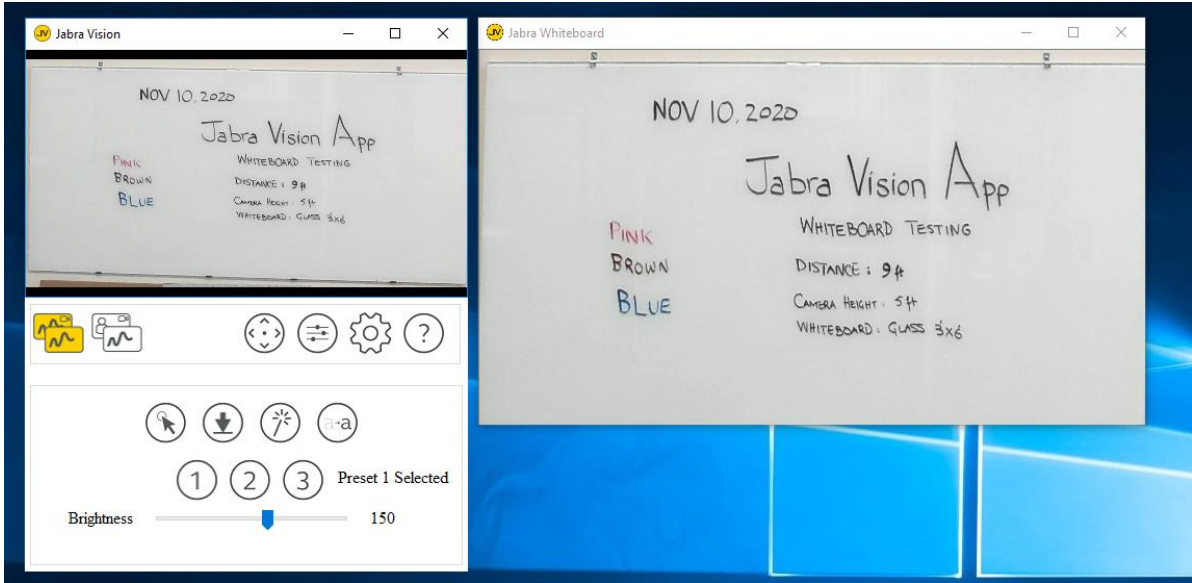

- For best results, the whiteboard should be parallel to the wall and not at an angle as shown below:

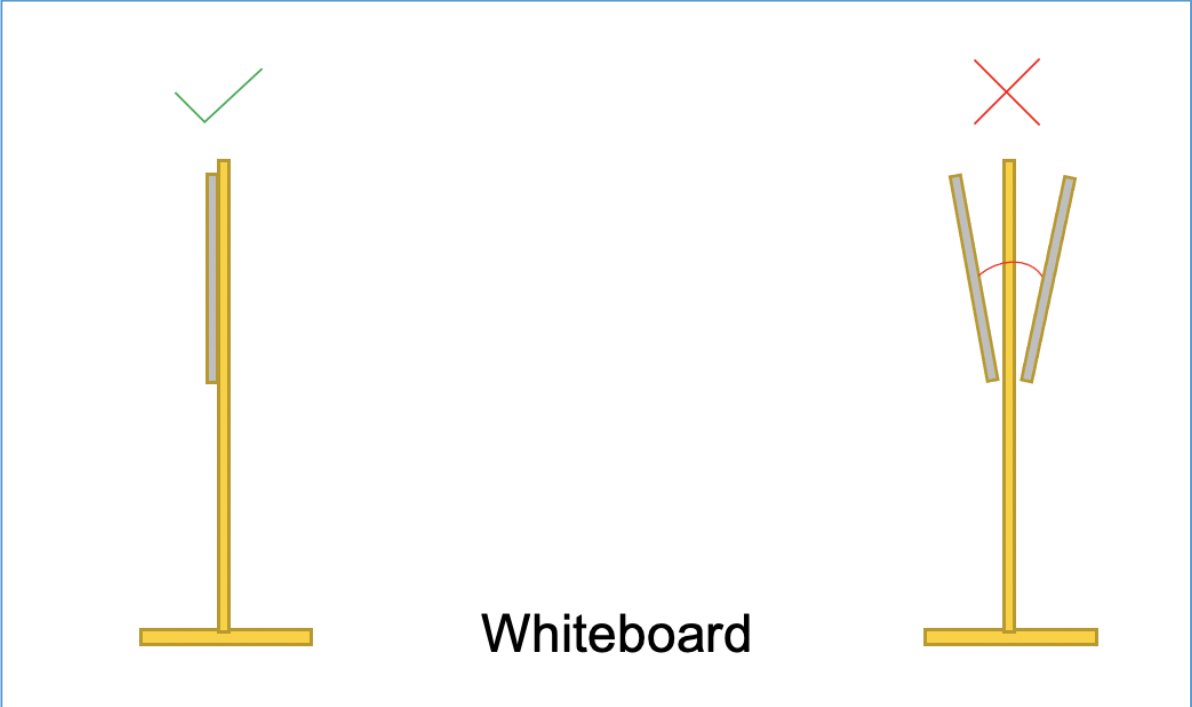

6. Use Jabra Vision to control your Jabra PanaCast

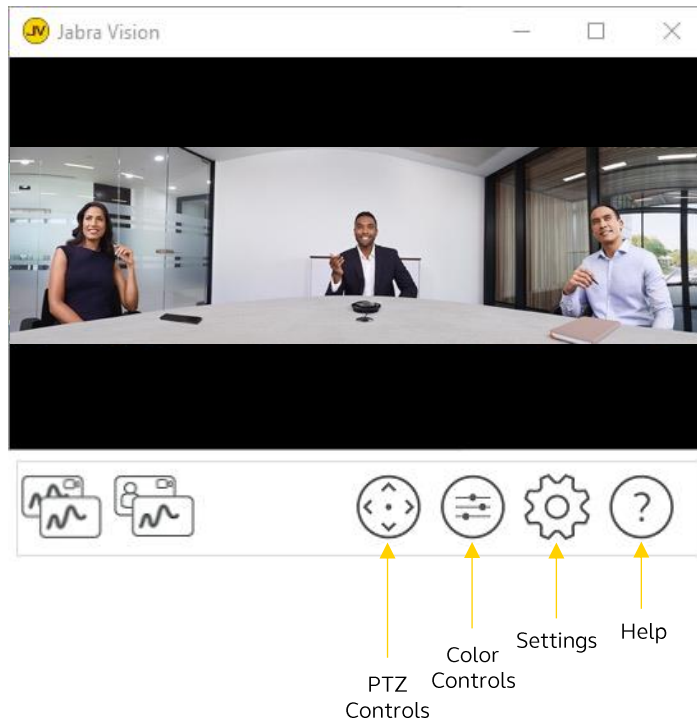







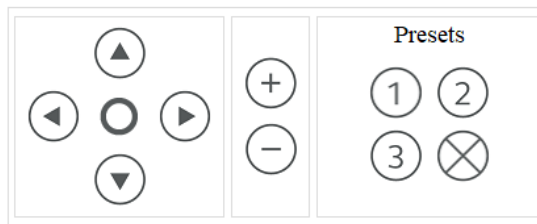

6.1 PTZ Controls

Click **PTZ Controls**  to bring up the control settings. You can also use your mouse to adjust PTZ controls.

*PTZ controls are unavailable when in the HQ Whiteboard Only mode



Video Pan-Tilt-Zoom Controls

- Reset the view  Zoom in  Preset 1
-  Pan left  Zoom out  Preset 2
-  Pan right  Preset 3
-  Tilt up  Clear presets

 Tilt down

Note: click and hold the preset button for 5 seconds to save the position

6.2 Color Controls

Click **Color Controls**  to change brightness, contrast, saturation, sharpness, and white balance.

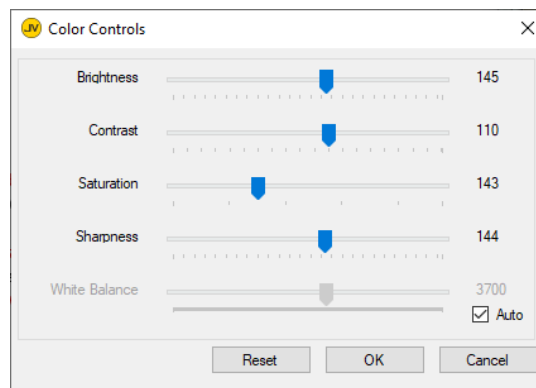

6.3 Settings

Click **Settings**  to change the Jabra Vision settings.

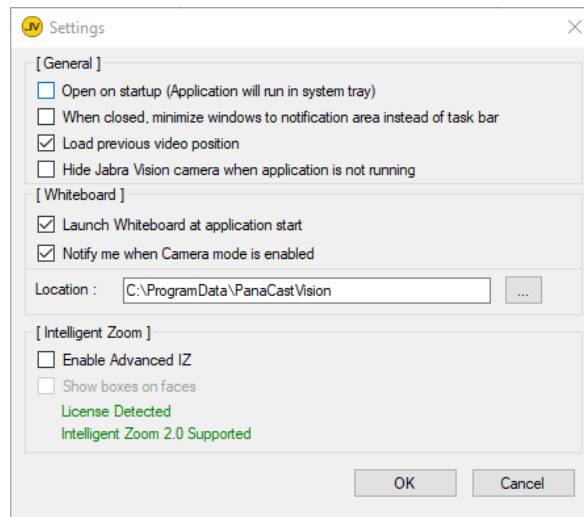

6.4 Help

Click **Help**  to access the support page.

7. How to check the Jabra Vision version

1. Go into the system tray and locate the Jabra Vision icon.

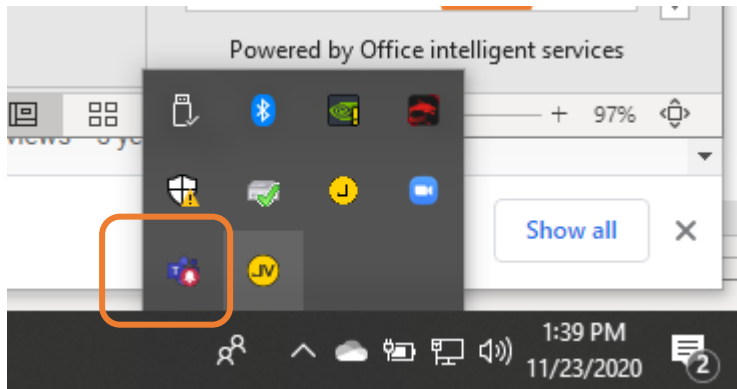

2. Right click on the Jabra Vision logo and click on “About”.

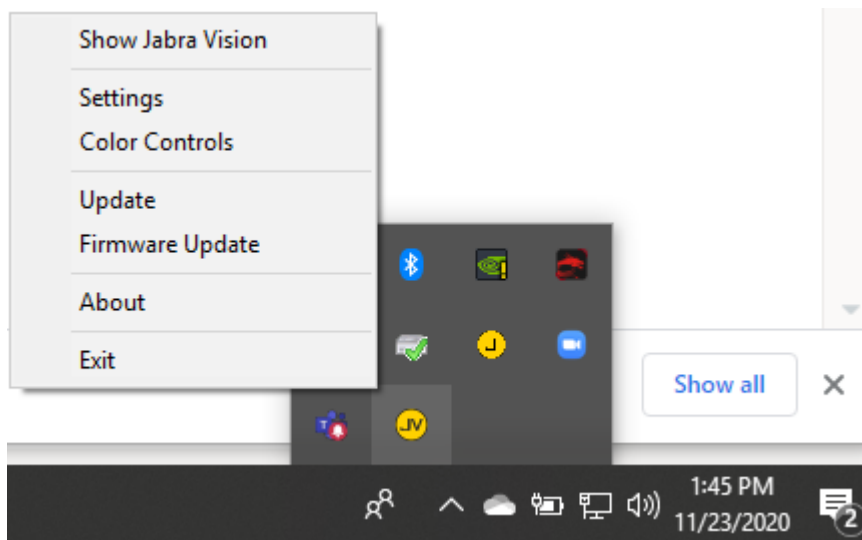

3. You can see the current Jabra Vision version.

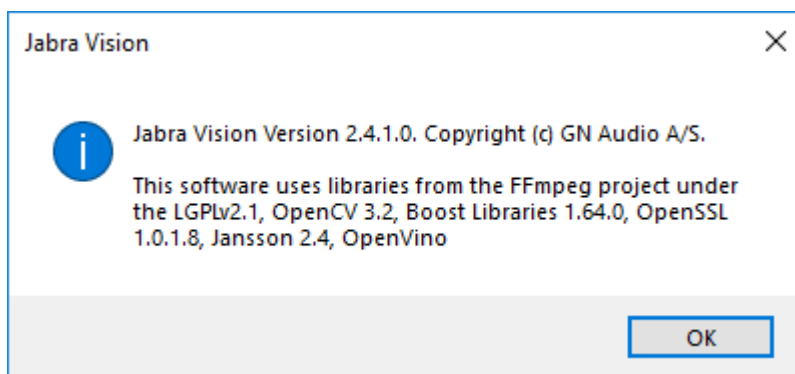

8. Having trouble connecting the camera?

You will see the image below if the Jabra Vision application cannot access the camera. The Jabra PanaCast device can be used by one application at a time.



Here are some steps that can help you to fix it

1. Check the LEDs of the Jabra PanaCast device. It should be white when the camera is in use. If you see blue LEDs, reconnect the camera.
2. Check the video settings in the video conferencing application that you're using. Make sure to select Jabra Vision as your camera instead of Jabra PanaCast.
3. Check if your Jabra PanaCast is in use by another application. Make sure to close other video conferencing applications when you're not using it.