



## Introduction

Welcome .....	2
AdderLink XDI 50 features .....	3
Tips for achieving good quality links .....	4
Supplied items .....	5
Optional extras .....	6

## Installation

Locations .....	7
Connections .....	8
Local video connection .....	8
Local USB connection .....	8
Local audio connection .....	9
Local serial port connection .....	9
Local data link connection .....	9
Local power connection .....	10
Remote video connection .....	11
EDID management .....	11
Remote USB connections .....	11
Remote audio connection .....	12
Remote serial port connection .....	12
Remote data link connection .....	12
Remote power connection .....	13

## Configuration

Mode switch settings .....	14
Firmware upgrades .....	15

## Operation

Indicators .....	16
------------------	----

## Further information

Getting assistance .....	17
Appendix 1 - Options port pin-out .....	18
Appendix 2 - Link cable interference protection .....	19
Warranty .....	20
Safety information .....	20
Radio frequency energy .....	21

## Index

# Introduction



## WELCOME

Thank you for choosing the AdderLink XD150 extender modules. These compact modules allow you to transfer the following connections up to 150 meters from your computer via a single link cable:

- High quality single link DVI digital video,
- USB keyboard and mouse plus two other USB devices (up to version 2.0),
- An RS232 serial device at speeds up to 115200 baud,
- Stereo speakers.



Thanks to our long involvement and investment in extender technology we have succeeded in overcoming the numerous problems associated with extending high speed signals.

The AdderLink XD150 extender modules are totally transparent in operation, leaving you free to use your computer as though you're still sitting next to it.

**Local**  
**XD150**  
**Local**  
**module**

150m maximum (see 'Higher rate or longer reach' above)

## Higher rate or longer reach?

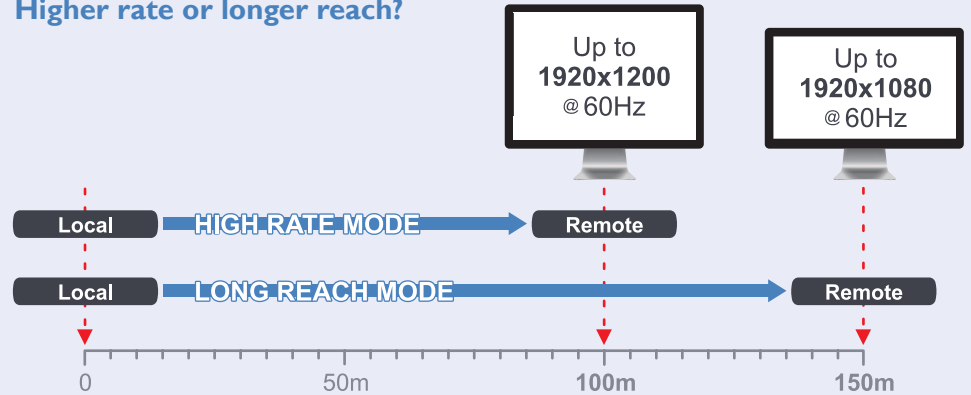

The AdderLink XD150 extenders provide two operational modes so that you can choose your priority: To support a higher resolution display (up to 1920 x 1200 @ 60Hz) or to cover a greater distance (up to 150 meters). A simple switch setting on the local module determines the required mode. When the high rate mode is enabled, the XD150 system will continually monitor the data link to ensure that image quality is being maintained. If the data link is not sufficient, the local module will automatically fall back to long reach mode.

### See also:

- [Tips for achieving good quality links](#)
- [Mode switch settings](#)

**Remote**  
**XD150**  
**Remote**  
**module**



One single link DVI-D display  
Four USB devices  
One RS232 serial device  
One set of stereo speakers

INSTALLATION

CONFIGURATION

OPERATION

FURTHER INFORMATION

INDEX

# ADDERLINK XD150 FEATURES

The local and remote modules are contained within slimline metal casings that measure just 169 x 116 x 31mm.



## Local module

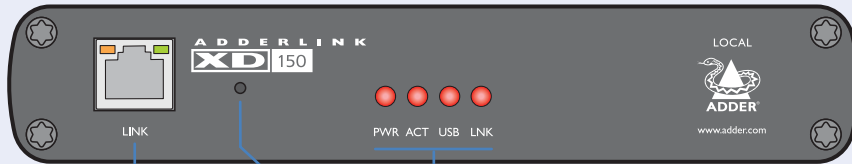

### CATx link to remote module

Do not connect to network devices of any kind. See [Local data link connection](#) for further details.

### Recessed reset button

### Status indicators

These provide visual confirmation of various system functions. See [Indicators](#) for further details.

### Mode switches

These allow you to determine specific behaviors. See [Mode switch settings](#) for further details.

### Options port

Used for RS232 serial devices. See [Local serial port connection](#) for further details.

### USB port

Connects to a USB port on your computer. See [Local USB connection](#) for further details.



### Power input

See [Local power connection](#) for further details.

### Upgrade port

Used for firmware upgrades to both modules. See [Firmware upgrades](#) for further details.

### Video port

Connects to the DVI-D video output port of your computer. See [Local video connection](#) for further details.

### Audio port

Connects to the speaker/audio output port of your computer. See [Local audio connection](#) for further details.

## Remote module

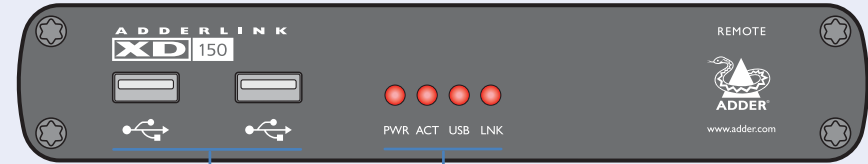

### USB ports

Connect your USB keyboard, mouse and other devices. See [Remote USB connections](#) for further details.

### Status indicators

These provide visual confirmation of various system functions. See [Indicators](#) for further details.

### USB ports

Connect your USB keyboard, mouse and other devices. See [Remote USB connections](#) for further details.

### Audio port

Connects to your speakers. See [Remote audio connection](#) for further details.

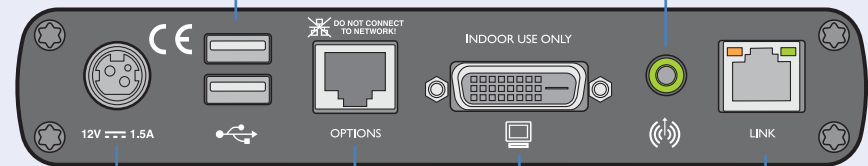

### Power input

See [Remote power connection](#) for further details.

### Options port

Used for RS232 serial devices. See [Remote serial port connection](#) for further details.

### Video port

Connects to your DVI-D video display. See [Remote video connection](#) for further details.

### CATx link to local module

Do not connect to network devices of any kind. See [Remote data link connection](#) for further details.

INSTALLATION

CONFIGURATION

OPERATION

FURTHER INFORMATION

INDEX

## TIPS FOR ACHIEVING GOOD QUALITY LINKS

Due to the large volumes of data that must be transferred between the local and remote modules, every AdderLink XD150 installation is highly dependent upon good quality CATx cable links. Video performance is particularly reliant on high speed communication channels. For this reason, the AdderLink XD150 units test the link quality to determine which of two transfer modes can be supported: High rate or Long reach.

The main factors that affect link quality are:

- The length and type of CATx cable used,
- The number, length and type of intermediate patch connections,
- The quality of the cable terminations.

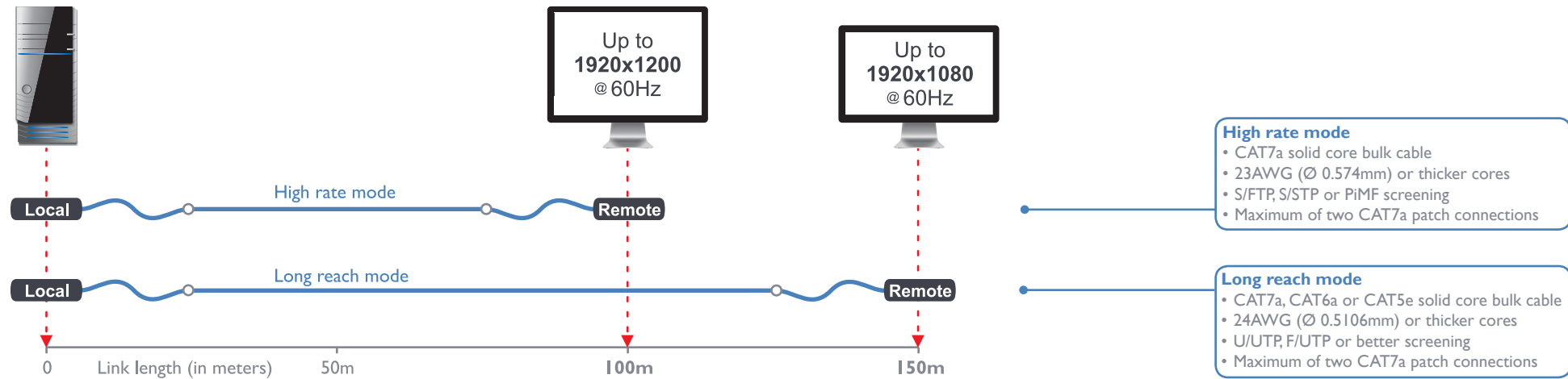

### Patch cables

As mentioned above, patch links affect performance. For each additional break/patch within a run, you will need to reduce the distance given above by roughly 5 meters.

For best results, patch cables should be of type CAT 7a and be less than 2 meters in length. If patch cables are greater than 2 meters, then they must be CAT 7a.

Adder recommend the following CAT 7 shielded, foiled, twisted pair cables:

- Flexible patch cable     Daetwyler 7702 (26AWG S/FTP)
- Bulk cable                 Daetwyler 7120 (23AWG S/FTP)

Please see [Appendix 2 - Link cable interference protection](#) for details about cable screening and shielding.

# SUPPLIED ITEMS

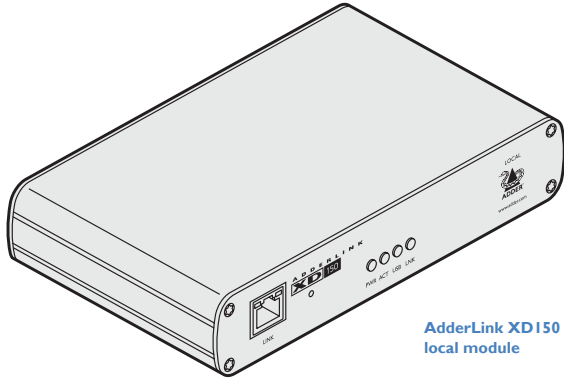

**AdderLink XD150**  
local module

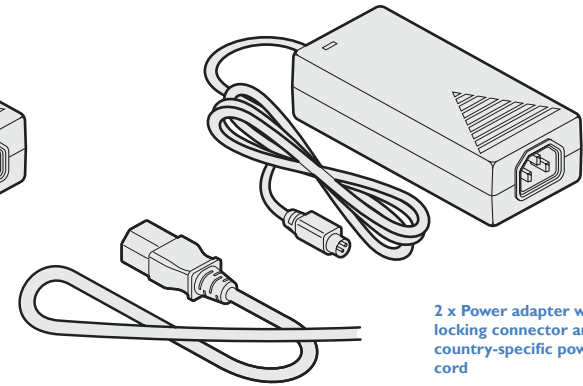
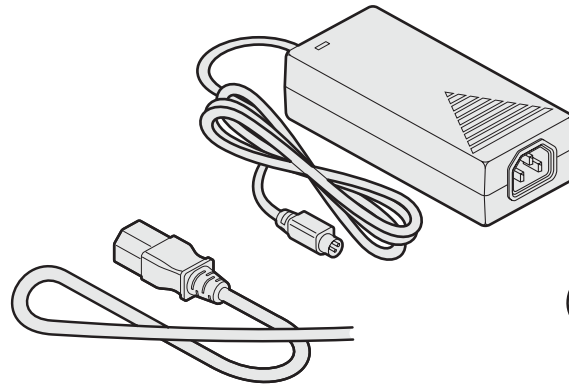

**2 x Power adapter with locking connector and country-specific power cord**



**AdderLink XD150**  
remote module

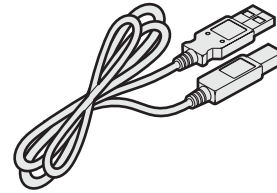

**USB cable 2m (type A to B)**

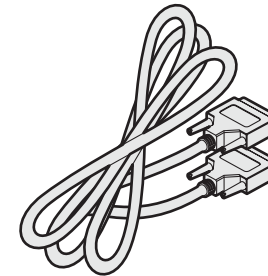

**Video cable DVI-D to DVI-D**

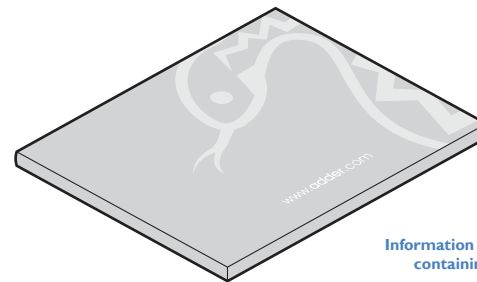

**Information wallet**  
containing:  
Eight self-adhesive rubber feet  
Safety document

# OPTIONAL EXTRAS

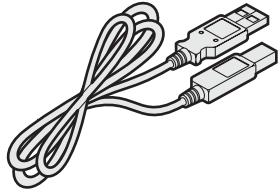

**USB cable 2m (type A to B)**  
Part number:VSC24

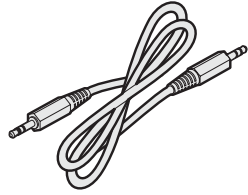

**Audio cable 2m (3.5mm stereo jacks)**  
Part number:VSC22

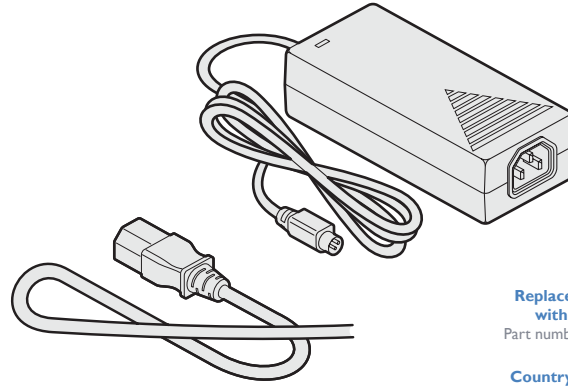

**Replacement power adapter with locking connector**  
Part number: PSU-IEC-12VDC-1.5A

- Country-specific power cords**
- CAB-IEC-AUS (Australia)
  - CAB-IEC-EURO (Central Europe)
  - CAB-IEC-UK (United Kingdom)
  - CAB-IEC-USA (United States)
  - CAB-IEC-JAPAN (Japan)

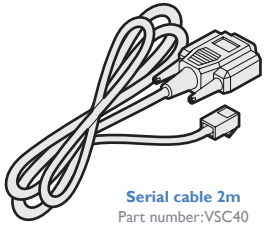

**Serial cable 2m**  
Part number:VSC40

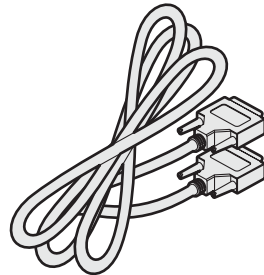

**Single link DVI-D to DVI-D video cable**  
Part number:VSCD1

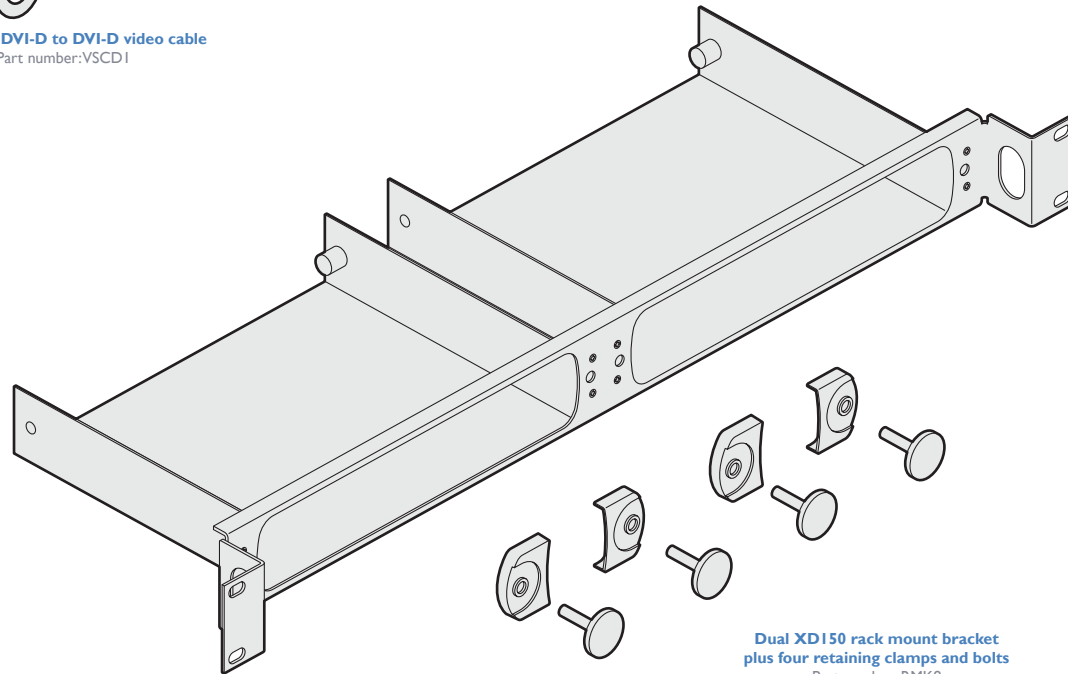

**Dual XD150 rack mount bracket plus four retaining clamps and bolts**  
Part number: RMK8

INSTALLATION

CONFIGURATION

OPERATION

FURTHER INFORMATION

INDEX

# Installation



## LOCATIONS

Please consider the following important points when planning the position of the AdderLink XD150 modules:

- Situate the local module close to the system to which it will be connected and near to a source of mains power. Place the remote module in similar close proximity to the peripherals that it will connect with, plus a source of mains power.
- Consult the precautions listed within the [Safety information](#) section.



## CONNECTIONS

Connections do not need to be carried out in the order given within this guide, however, where possible connect the *power in* as a final step. The local module connects to your computer while the remote module links with your peripherals.

### Local video connection

When operating in *High Rate* mode, AdderLink XD150 can support one Single Link DVI video display at pixel clocks up to 165MHz (equivalent to a maximum resolution of 1920 x 1200 at 60Hz - aka 'WUXGA'). If the *Long Reach* mode is selected, pixel clocks up to 148.5MHz (equivalent to a maximum resolution of 1920 x 1080 at 60Hz - aka '1080P') are supported. This allows greater separation between the local and remote modules to be achieved. Please see the section [Mode switch settings](#) for details.

#### To connect the video port

- 1 Connect the supplied digital video link cable between the DVI-D socket on the local module rear panel and the DVI-D video output socket of your host computer.

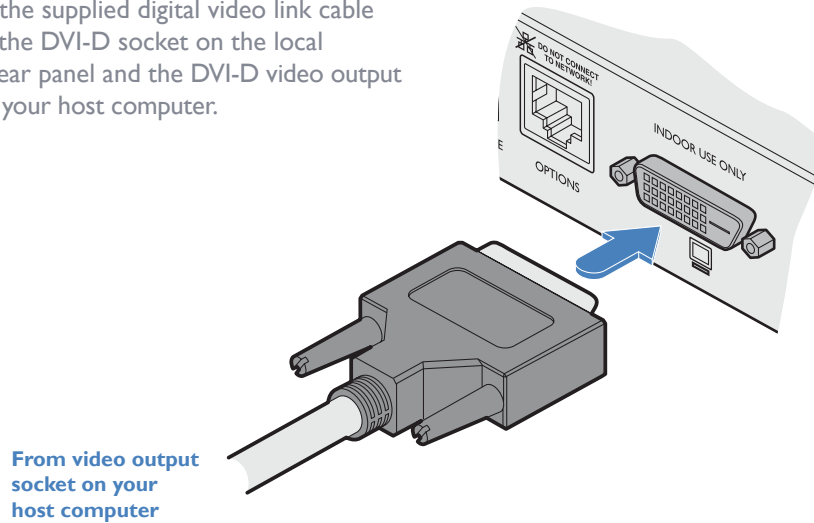

### Local USB connection

If USB connectivity is required, then a single USB connection is necessary between the local module and your computer; the AdderLink XD150 remote module acts as a USB 2.0 hub and thus provides four sockets for your peripherals.

#### To connect the USB port

- 1 Connect the supplied USB cable between the USB port on the local module rear panel and a vacant USB socket on your host computer.

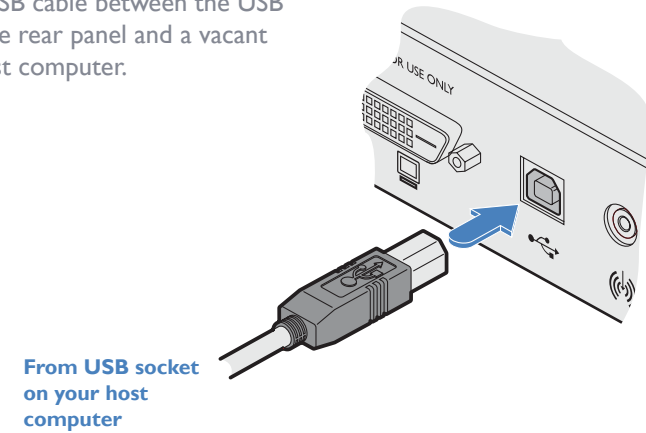

## Local audio connection

The AdderLink XD150 modules support stereo speakers. A connection to the audio output port of the host computer is required at the local module.

### To connect the audio port

- 1 Connect an audio link cable (Adder part number: VSC22) between the audio socket on the local module rear panel and the speaker/audio output socket of your host computer.

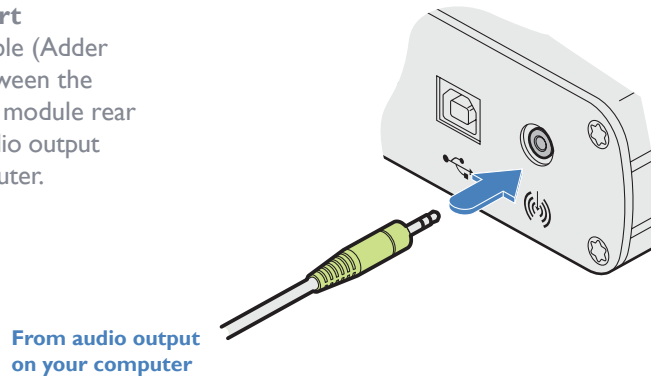

## Local serial port connection

The Options port provides an RS232 serial connection with the remote module. When serial devices are attached to the Options ports on the local and remote modules, the units transparently convey the signals between them, via the CATx link, at rates up to 115200 baud - no serial configuration is required. An optional serial cable (part number: VSC40) is available from Adder.

### To connect the serial port

- 1 Use the optional serial cable (VSC40) to link the Options port on the rear panel of the local module with a vacant RS232 serial port on your host computer.

This is NOT an ethernet/network port and must NEVER be connected to any networking equipment.

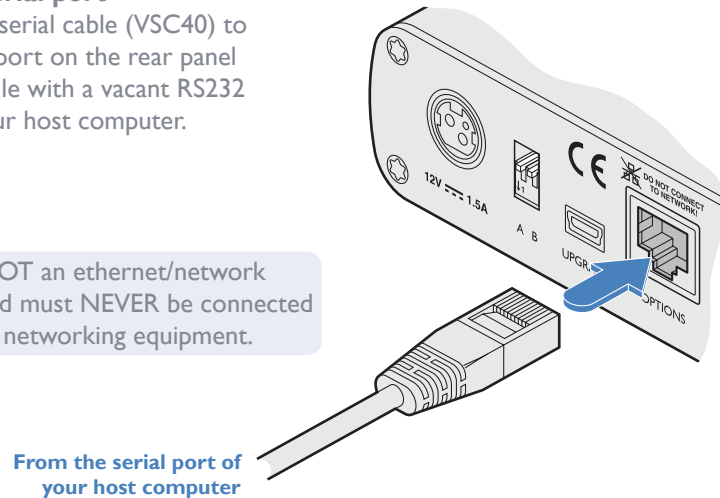

## Local data link connection

The local and remote modules require a direct connection between them using standard CATx cables and connectors. This is a proprietary data link and is NOT network compatible; the modules must NEVER be connected to any networking equipment, such as switches and routers.

When operating in *High Rate* mode, AdderLink XD150 can support cable distances up to 100 meters. If the *Long Reach* mode is selected, the separation between the local and remote modules can be increased to 150 meters. Best results will be gained when single lengths of CAT7 cable are used without the need for patch cables.

### To connect the data link cable

- 1 Connect the CATx cable from the remote module to the LINK port on the front panel of the local module.

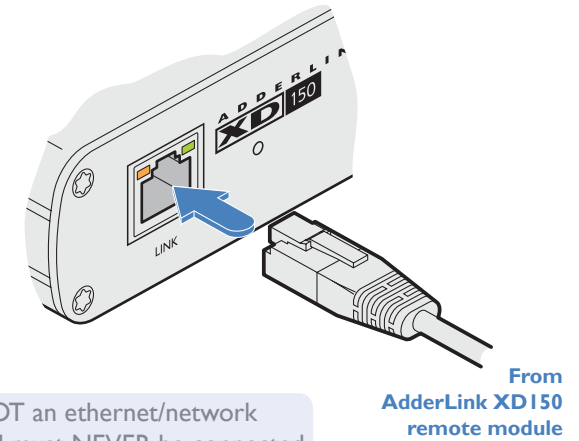

This is NOT an ethernet/network port and must NEVER be connected to any networking equipment.

## Local power connection

There is no on/off switch on either of the AdderLink XD150 modules, so operation begins as soon as power is applied. The power adapters supplied with the modules use locking-type plugs to help prevent accidental disconnections; please follow the instructions given right whenever disconnecting a power adapter.

### To connect the power adapter

- 1 Attach the output plug of the supplied power adapter to the power input socket on the left side of the rear panel.

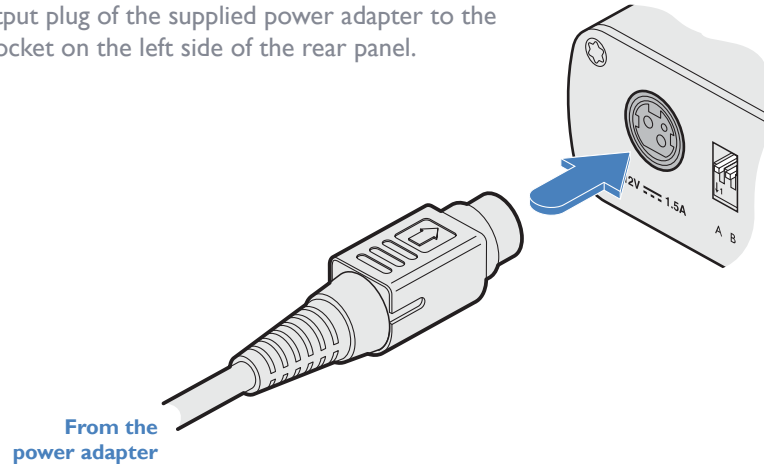

- 2 If any mode changes need to be made, adjust the switch settings before applying power to the local module. Please see the section [Mode switch settings](#) for details.
- 3 Connect the IEC connector of the supplied country-specific power cord to the socket of the power adapter.

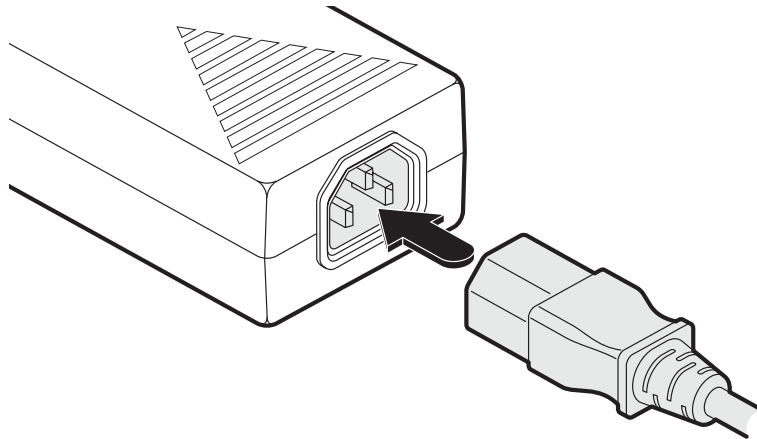

- 4 Connect the power cord to a nearby main supply socket.

### To disconnect the power adapter

- 1 Isolate the power adapter from the mains supply.
- 2 Grasp the outer body of the power adapter plug where it connects with the module.
- 3 Gently pull the body of the outer plug away from the module. As the body of the plug slides back, it will release from the socket and you can fully withdraw the whole plug.

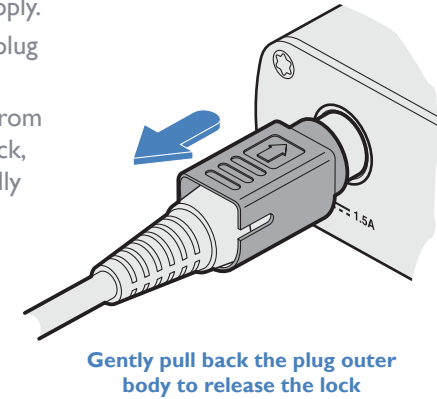

**IMPORTANT:** Please read and adhere to the electrical safety information given within the [Safety information](#) section of this guide. In particular, do not use an unearthed power socket or extension cable.

*Note: Both the modules and the power supplies generate heat when in operation and will become warm to the touch. Do not enclose them or place them in locations where air cannot circulate to cool the equipment. Do not operate the equipment in ambient temperatures exceeding 40 degrees Centigrade. Do not place the products in contact with equipment whose surface temperature exceeds 40 degrees Centigrade.*

## Remote video connection

A Single Link DVI-D port is provided on the rear panel of the remote module. The bandwidth available at the port is determined by the video input at the local module and also the mode in which the AdderLink XD150 system is running. When high rate mode is used, the modules will continually check the link quality to ensure that it is capable of supporting the higher pixel clock. If excessive data errors are detected, the modules will fall back to *Long Reach* mode until the local module is reset or the link is broken and re-established.

AdderLink XD150 can support one Single Link DVI video display at pixel clocks up to 165MHz (equivalent to a maximum resolution of 1920 x 1200 at 60Hz - aka 'WUXGA') when operating in *High Rate* mode. If the *Long Reach* mode is selected, pixel clocks up to 148.5MHz (equivalent to a maximum resolution of 1920 x 1080 at 60Hz - aka '1080P') in order to allow greater separations between the local and remote modules to be achieved. Please see the section [Mode switch settings](#) for details.

### To connect the video display

- 1 Connect the DVI-D video cable from your video display to the video output port on the rear panel of the remote module.

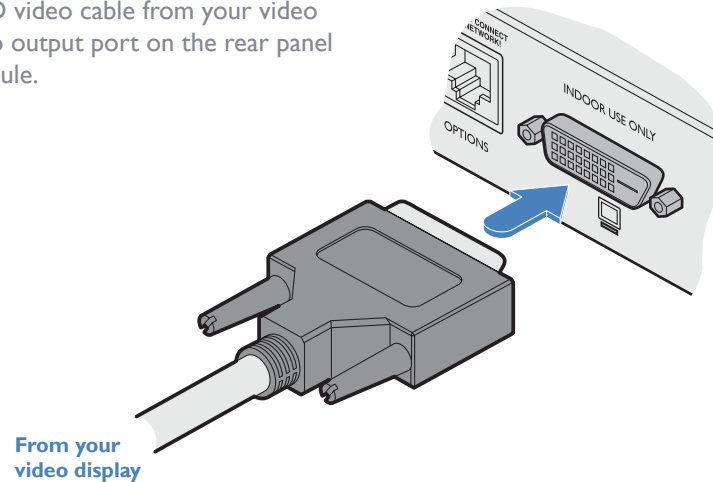

## EDID management

When a remote module is connected and the video display attached to it is detected, the EDID (Extended Display Identification Data) information is cloned and stored at the local module. Once this is done, a transparent DDC/CI (Display Data Channel/Command Interface) two way communication link is provided between the video display and the video source (your host computer). If the remote monitor is removed then the cloned EDID stored at the local module will still be presented to the video source.

## Remote USB connections

The remote module contains a USB hub that can support up to four v1.1 or v2.0 USB devices (in any combination). All four USB sockets are identical in operation.

### To connect USB devices

- 1 Connect your USB keyboard, mouse and any other two USB devices to the four sockets distributed on the front and rear panels of the remote module.

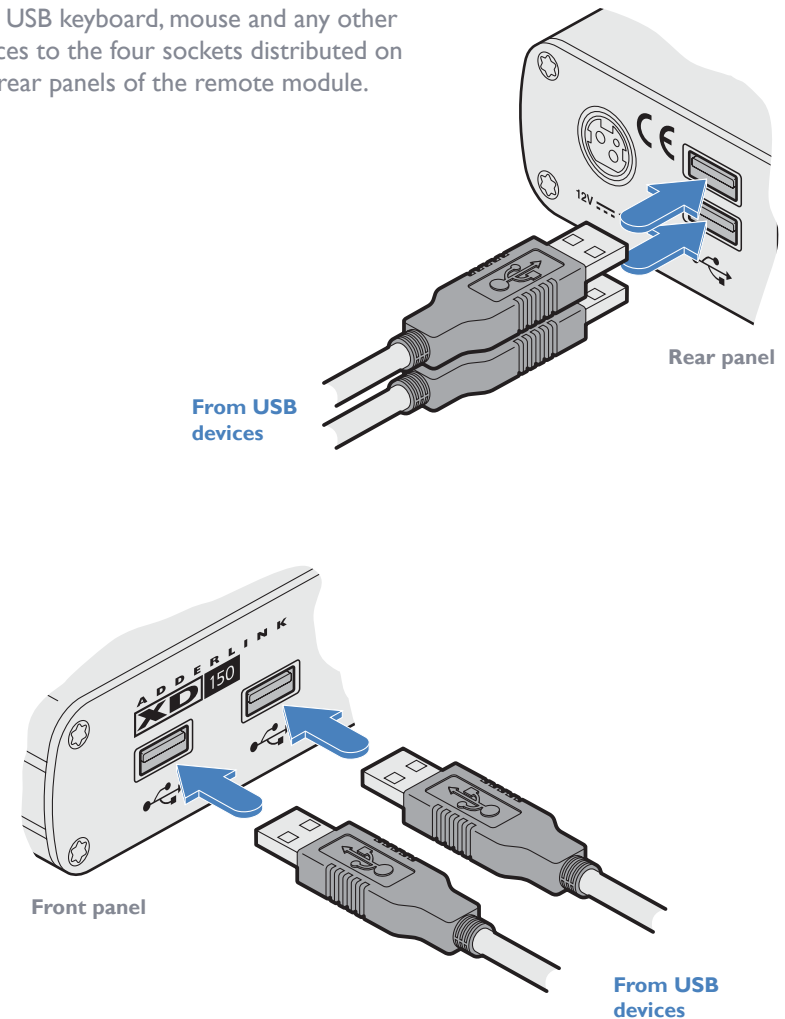

## Remote audio connection

The AdderLink XD150 modules support stereo speakers.

### To connect your speakers

- 1 Connect your speakers to the audio socket on the remote module rear panel.

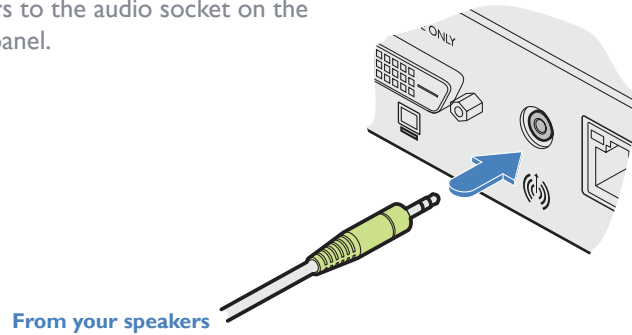

## Remote serial port connection

The Options port provides an RS232 serial connection with the local module. When serial devices are attached to the Options ports on the local and remote modules, the units transparently convey the signals between them, via the CATx link, at rates up to 115200 baud - no serial configuration is required. An optional serial cable (part number: VSC40) is available from Adder.

### To connect the serial port

- 1 Use the optional serial cable (VSC40) to link the Options port on the rear panel of the remote module with your RS232 serial device.

This is NOT an ethernet/network port and must NEVER be connected to any networking equipment.

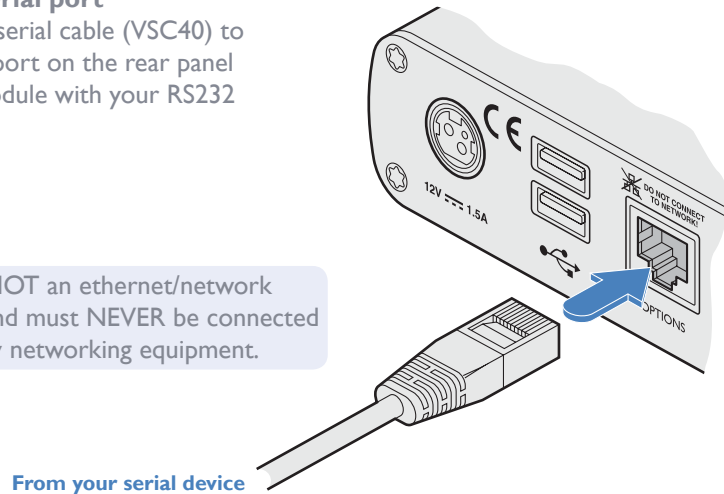

## Remote data link connection

The local and remote modules require a direct connection between them using standard CATx cables and connectors. This is a proprietary data link and is NOT network compatible; the modules must NEVER be connected to any networking equipment, such as switches and routers.

When operating in *High Rate* mode, AdderLink XD150 can support cable distances up to 100 meters. If the *Long Reach* mode is selected, the separation between the local and remote modules can be raised up to 150 meters. Best results will be gained when single lengths of CAT7 cable are used without the need for patch cables.

### To connect the data link cable

- 1 Connect the CATx cable from the local module to the LINK port on the rear panel of the remote module.

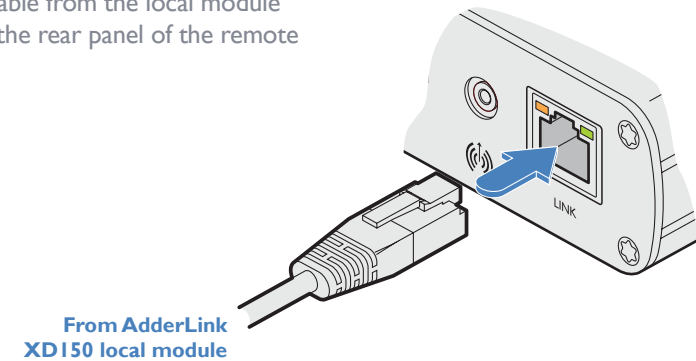

This is NOT an ethernet/network port and must NEVER be connected to any networking equipment.

Please see [Appendix I](#) for pin-out details of the Options port.

## Remote power connection

There is no on/off switch on either of the AdderLink XD150 modules, so operation begins as soon as power is applied. The power adapters supplied with the modules use locking-type plugs to help prevent accidental disconnections; please follow the instructions given right whenever disconnecting a power adapter.

### To connect the power adapter

- 1 Attach the output plug of the supplied power adapter to the power input socket on the left side of the rear panel.

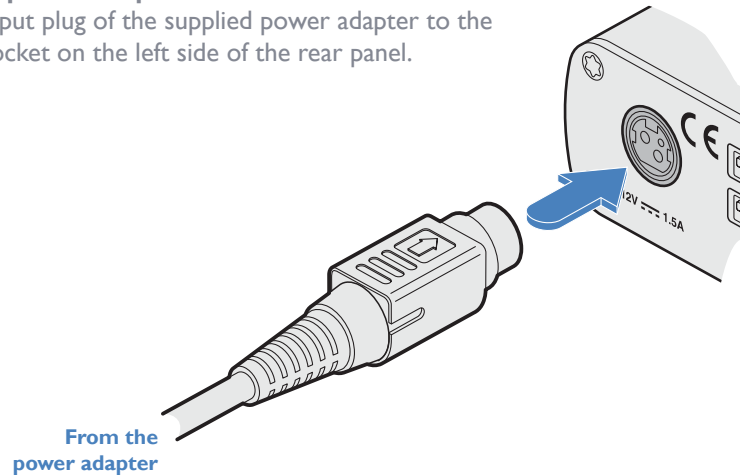

- 2 Connect the IEC connector of the supplied country-specific power cord to the socket of the power adapter.

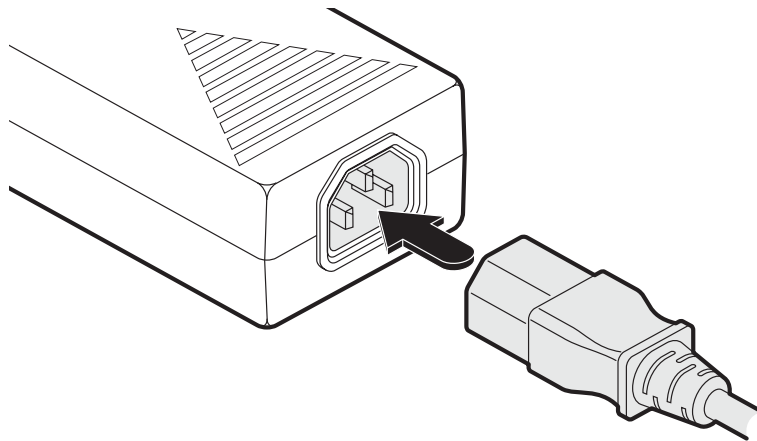

- 3 Connect the power cord to a nearby main supply socket.

### To disconnect the power adapter

- 1 Isolate the power adapter from the mains supply.
- 2 Grasp the outer body of the power adapter plug where it connects with the module.
- 3 Gently pull the body of the outer plug away from the module. As the body of the plug slides back, it will release from the socket and you can fully withdraw the whole plug.

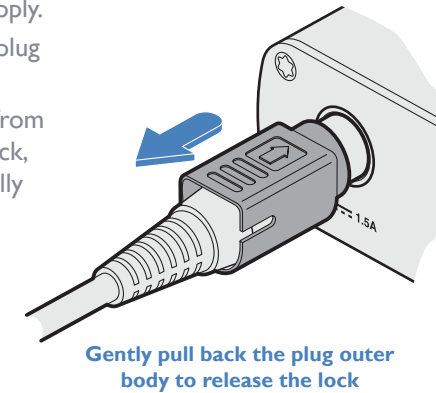

**IMPORTANT:** Please read and adhere to the electrical safety information given within the [Safety information](#) section of this guide. In particular, do not use an unearthed power socket or extension cable.

*Note: Both the modules and the power supplies generate heat when in operation and will become warm to the touch. Do not enclose them or place them in locations where air cannot circulate to cool the equipment. Do not operate the equipment in ambient temperatures exceeding 40 degrees Centigrade. Do not place the products in contact with equipment whose surface temperature exceeds 40 degrees Centigrade.*

## MODE SWITCH SETTINGS

The local module has two small switches on its rear panel. These are used to determine which operation modes should be used. You will need to re-power the local module whenever a switch setting is changed.

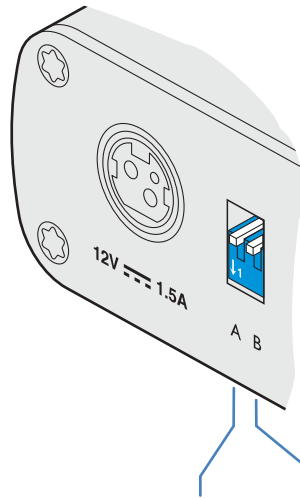

**Local module rear panel**

*Note: The default position for both switches is **UP**, thus selecting Long reach mode and high speed (normal) USB mode.*



Changes to the mode switches are not recognized until you re-apply power to the local module.

### Switch A USB compatibility mode

Determines whether USB compatibility mode should be used.

**UP** - Normal mode - Use this if the modules are not connected to a KVM switch.

**DOWN** - Compatibility mode - Use this if either the local or remote modules are connected to a KVM switch. This mode ensures robust and reliable operation with KVM switches but also reduces the maximum USB data rate.

### Switch B Link mode

Determines the priority for the data link: Longer distance or higher screen resolution.

**UP** - Long reach mode - Limits the pixel clock (148.5MHz) so that longer stretches of link cable (exceeding 100m) can be used. This will restrict the achievable screen resolution to a maximum of 1920 x 1080 at 60Hz (aka '1080P').

**DOWN** - High rate mode - Allows a higher pixel clock (165MHz) to support screen resolutions of up to 1920 x 1200 at 60Hz (aka 'WUXGA'). This will limit the maximum link cable length to around 100m or less, depending on the type of link cable used.

*Note: When high rate mode is used, the modules will continually check the link quality to ensure that it is capable of supporting the higher pixel clock. If excessive data errors are detected, the modules will fall back to Long Reach mode until the local module is reset or the link is broken and re-established.*

## FIRMWARE UPGRADES

Both modules can be upgraded simultaneously by linking them together and then connecting them to your computer using a USB type-A to mini-B cable.

**IMPORTANT:** During the upgrade process, do not remove power from either module.

### To enter upgrade mode

- 1 On your computer, download the latest AdderLink XD150 upgrade file from [adder.com](http://adder.com).
- 2 Connect the local and remote modules together using a CATx cable, and power on both modules. It's not important whether any peripherals (if any) are attached to either module.
- 3 Connect the local module to your computer using the mini USB socket on the rear panel and a USB type-A to mini-B cable (not supplied).

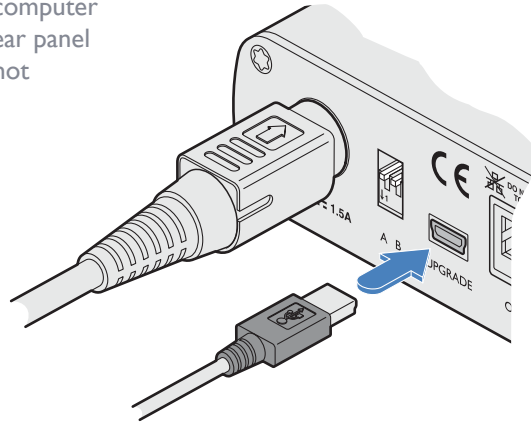

- 4 On the front panel of the local module, use a small implement or straightened paperclip to press and hold the recessed reset button for approximately 10 seconds.

The front panel indicators will begin to flash in sequence: The outer two followed by the inner two and so on.

The module should be declared on your computer as a mass storage device with the volume label 'FIRMWARE'.

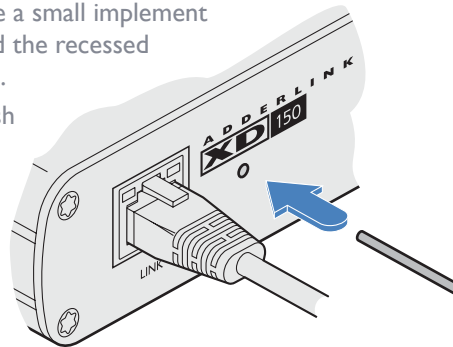

- 5 Use your computer's file manager application to copy the upgrade file downloaded earlier to the mass storage device that has the volume label 'FIRMWARE'. Once the local module has received all of the data, the front panel indicators of the local module will chase from side to side to show that the upgrade procedure is underway.
- 6 Once the upgrade has been successfully completed both modules will reset themselves and return to normal operation.

### Errors during the upgrade process

If the upgrade process encounters an error then one or more of the indicators on the local module front panel will flash rapidly, i.e. they will cease chasing in sequence.

### If the firmware upgrade fails

- 1 Check that the CATx cable is correctly connected between the **LINK** sockets of the local and remote modules and that power is applied to both modules.
- 2 On the front panel of the local module, re-press the recessed reset button for approximately 10 seconds to re-invoke upgrade mode. The module should again be declared on your computer as a mass storage device with the volume label 'FIRMWARE'.
- 3 Follow step 5 above.
  - If the upgrade process fails again, contact Adder technical support for assistance.



The AdderLink XD150 modules are designed to be transparent in operation. Providing the link cable is sufficient to reliably carry the signals across the separation distance, all peripherals should respond exactly as they would when situated next to your host computer.

## INDICATORS

The local and remote modules contain various indicators to provide you with status information. Both modules have four red indicators on their front panels; both also have green and amber indicators on the link connectors.

### Red status indicators

The red status indicators on the front panels of each module mostly behave in the same manner at the same time:

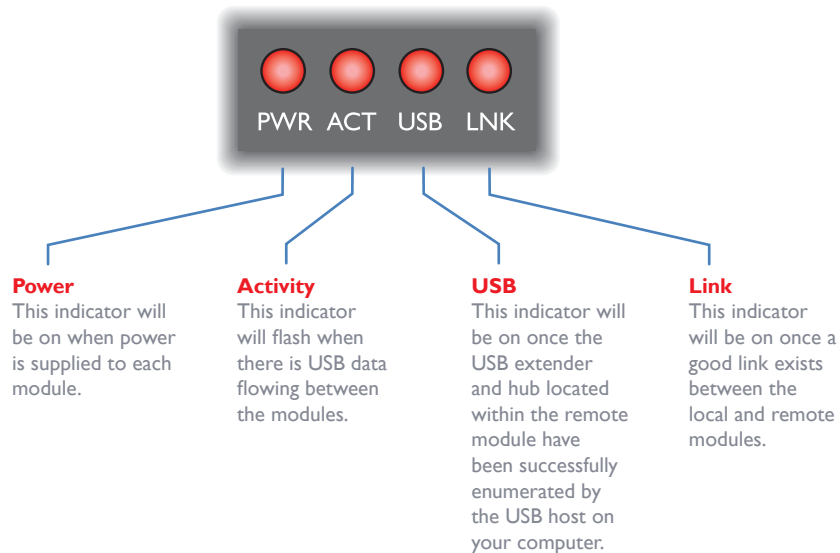

### Green and amber status indicators

The green and amber status indicators on the link connectors of each module provide further status information:

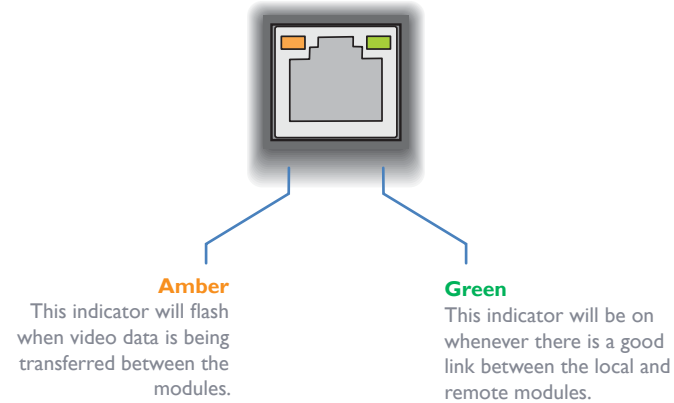

# Further information



This chapter contains a variety of information, including the following:

- Getting assistance - see right
- [Appendix 1](#) - Options port pin-out
- [Appendix 2](#) - Link cable interference protection
- [Safety information](#)
- [Warranty](#)
- [Radio frequency energy statements](#)

## GETTING ASSISTANCE

If you are still experiencing problems after checking the information contained within this guide, then we provide a number of other solutions:

- **Online solutions and updates** – [www.adder.com/support](http://www.adder.com/support)  
Check the Support section of the adder.com website for the latest solutions and firmware updates.
- **Adder Forum** – [forum.adder.com](http://forum.adder.com)  
Use our forum to access FAQs and discussions.
- **Technical support** – [www.adder.com/contact-support-form](http://www.adder.com/contact-support-form)  
For technical support, use the contact form in the Support section of the adder.com website - your regional office will then get in contact with you.

INSTALLATION

CONFIGURATION

OPERATION

FURTHER  
INFORMATION

INDEX

## APPENDIX I - OPTIONS PORT PIN-OUT

The **OPTIONS** port uses a 10p10c socket which can accommodate both 10p10c connectors as well as the much more common 8p8c connectors, which are used on Ethernet leads and patch cables. The pin-outs are listed in this section for both types of connector.

*Note: Although the pins labeled 'Not used' are inactive, they are still connected internally and so no links should be made at all to these pins.*

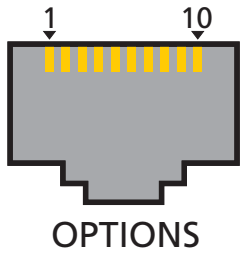

8p8c	10p10c	Signal
	1	Not used
1	2	5VDC power output (100mA max)
2	3	GND reference for all signals
3	4	RS232 (RXD) data receive
4	5	Not used
5	6	Not used
6	7	RS232 (TXD) data transmit
7	8	Not used
8	9	Not used
	10	Not used

## APPENDIX 2 - LINK CABLE INTERFERENCE PROTECTION

While the Category rating (e.g. CAT 5e, CAT 6a, CAT 7, etc.) determines the electrical performance of a cable, another vital part of the overall cable specification is its protection from interference. As cabling distances and data rates increase, so too does the susceptibility to interference, from both external and internal sources.

Proximity to other electromagnetic sources are the main external threat and these can be subdued using overall screening that surrounds all four of the cable pairs. However, interference is also possible from neighbouring twisted pairs within the same cable and this can be just as hazardous to data integrity. Such *crosstalk* is countered by shielding each cable pair separately.

Within each Category rating, you can specify different combinations of external screening and internal shielding to suit the environment into which the link is being placed. Please see the section [Tips for achieving good quality links](#) for suggested combinations.

### Interference protection codes

Interference protection is now classified in the following manner:

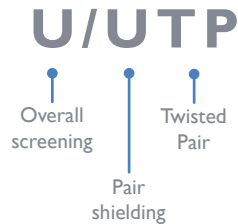

- where
- U** = unshielded
  - F** = foil shielding
  - S** = braided shielding
  - PiMF** = Pairs in Metal Foil

Name	Overall Screening	Pair Shielding
U/UTP	✗	✗
F/UTP	✓	✗
U/FTP	✗	✓
S/FTP or S/STP or PiMF	✓	✓

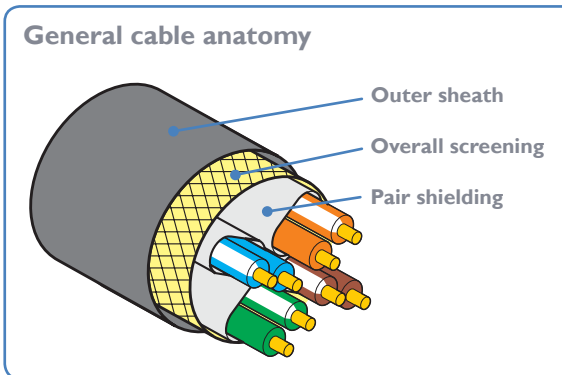
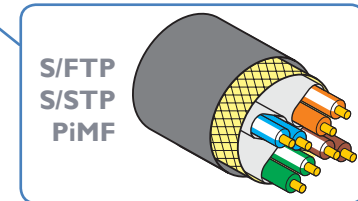
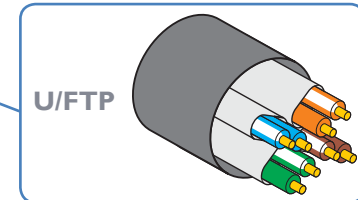
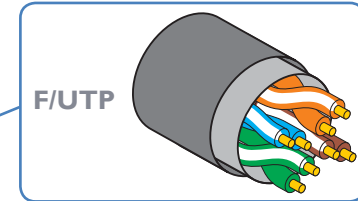
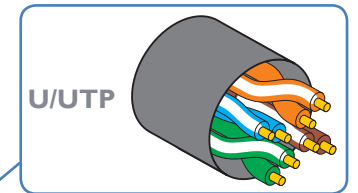

## SAFETY INFORMATION

- For use in dry, oil free indoor environments only.
- Warning - live parts contained within power adapter(s).
- No user serviceable parts within power adapter(s) - do not dismantle.
- Plug the power adapter(s) into socket outlets close to the module that they are powering.
- Do not use an unearthed power socket or extension cable.
- Do not use a power adapter if its case becomes damaged, cracked or broken or if you suspect that it is not operating properly.
- Replace the power adapter(s) with a manufacturer approved type only.
- If you use a power extension cord with the module, make sure the total ampere rating of the devices plugged into the extension cord does not exceed the cord's ampere rating. Also, make sure that the total ampere rating of all the devices plugged into the wall outlet does not exceed the wall outlet's ampere rating.
- Do not attempt to service the modules yourself.

## WARRANTY

Adder Technology Ltd warrants that this product shall be free from defects in workmanship and materials for a period of two years from the date of original purchase. If the product should fail to operate correctly in normal use during the warranty period, Adder will replace or repair it free of charge. No liability can be accepted for damage due to misuse or circumstances outside Adder's control. Also Adder will not be responsible for any loss, damage or injury arising directly or indirectly from the use of this product. Adder's total liability under the terms of this warranty shall in all circumstances be limited to the replacement value of this product.

If any difficulty is experienced in the installation or use of this product that you are unable to resolve, please see the [Getting assistance](#) section.



## RADIO FREQUENCY ENERGY

A Category 5e (or better) twisted pair cable must be used to connect the units in order to maintain compliance with radio frequency energy emission regulations and ensure a suitably high level of immunity to electromagnetic disturbances.

All cables used with this equipment must be shielded in order to maintain compliance with radio frequency energy emission regulations and ensure a suitably high level of immunity to electromagnetic disturbances.

## European EMC directive 2004/108/EC

This equipment has been tested and found to comply with the limits for a class A computing device in accordance with the specifications in the European standard EN55022. These limits are designed to provide reasonable protection against harmful interference. This equipment generates, uses and can radiate radio frequency energy and if not installed and used in accordance with the instructions may cause harmful interference to radio or television reception. However, there is no guarantee that harmful interference will not occur in a particular installation. If this equipment does cause interference to radio or television reception, which can be determined by turning the equipment on and off, the user is encouraged to correct the interference with one or more of the following measures: (a) Reorient or relocate the receiving antenna. (b) Increase the separation between the equipment and the receiver. (c) Connect the equipment to an outlet on a circuit different from that to which the receiver is connected. (d) Consult the supplier or an experienced radio/TV technician for help.

## FCC Compliance Statement (United States)

This equipment generates, uses and can radiate radio frequency energy and if not installed and used properly, that is, in strict accordance with the manufacturer's instructions, may cause interference to radio communication. It has been tested and found to comply with the limits for a class A computing device in accordance with the specifications in Subpart J of part 15 of FCC rules, which are designed to provide reasonable protection against such interference when the equipment is operated in a commercial environment. Operation of this equipment in a residential area may cause interference, in which case the user at his own expense will be required to take whatever measures may be necessary to correct the interference. Changes or modifications not expressly approved by the manufacturer could void the user's authority to operate the equipment.

## Canadian Department of Communications RFI statement

This equipment does not exceed the class A limits for radio noise emissions from digital apparatus set out in the radio interference regulations of the Canadian Department of Communications.

*Le présent appareil numérique n'émet pas de bruits radioélectriques dépassant les limites applicables aux appareils numériques de la classe A prescrites dans le règlement sur le brouillage radioélectriques publié par le ministère des Communications du Canada.*

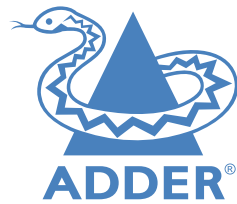

Web: [www.adder.com](http://www.adder.com)

Contact: [www.adder.com/contact-details](http://www.adder.com/contact-details)

Support: [forum.adder.com](http://forum.adder.com)

- A**
  - Audio
    - local module 9
    - remote module 12
- C**
  - Cable pairs 19
  - Cable types 19
  - Category rating 19
  - CATx 4
  - Crosstalk 19
- D**
  - Data link
    - local module 9
    - remote module 12
- E**
  - EDID management 11
- F**
  - Firmware upgrade 15
- H**
  - High rate mode 2
- I**
  - Indicators 16
  - Interference
    - protection 19
- L**
  - Link quality 4
  - Long reach mode 2
- M**
  - Mode switches 14
- P**
  - Patch cable 4
  - Peripherals
    - connecting 8
  - Power
    - local module 10
    - remote module 13
- R**
  - Reset button 3,15
  - RS232 9,12
- S**
  - Safety information 20
  - Screening 19
  - Serial port
    - local module 9
    - remote module 12
  - Shielding 19
  - Switch settings 14
- U**
  - USB
    - local module 8
    - remote module 11
- V**
  - Video
    - local module 8
    - remote module 11
- W**
  - Warranty 20