



PointWrite User Manual

Table of contents

Shipping Contents..... 3

Product Overview..... 4

About Touch Module 4

Dimensions 5

Preparation for Setup.. 6

Environment Condition 6

Surface Condition 7

Projector Requirements..... 10

Touch Module Installation 11

Driver Installation 13

Connection..... 14

Configuration

Setting 16

Alignment

Instructions..... 17

Alignment View 17

Adjustment for Touch Module

Laser Curtain 18





PointWrite

Calibration..... 21

Specifications..... 22

Shipping Contents

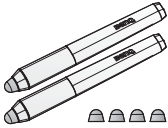
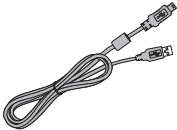
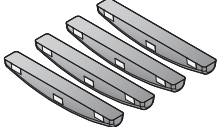
The PointWrite touch module is a touch transmitter for the BenQ PointWrite interactive projector. To use the touch module, please find the standard accessories below and follow this manual.

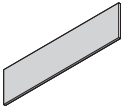
| | | |
|--|--|--|
| 1  | 2  | 3  |
| PointWrite Touch Module | Quick manual | Dummy pen with pen nibs x 2 |
| 4  | 5  | 6  |
| Mini USB cable | Alignment masks | Wrist strip x 2 |
| 7  | | |
| Tape x 2 | | |

1. PointWrite Touch Module
2. Quick Start Guide: Shortcut of how to use the PointWrite touch solution.
3. Dummy pen with pen nibs: 2 extra pen nibs for dummy pen.
4. Mini USB Cable: Connect to supply power to the touch module.
5. Alignment masks: For laser curtain alignment.
6. Wrist strip x 2
7. Tape x 2

About Dummy Pen

☞ When replacing the pen nib on the dummy pen, take it from the dummy pen.

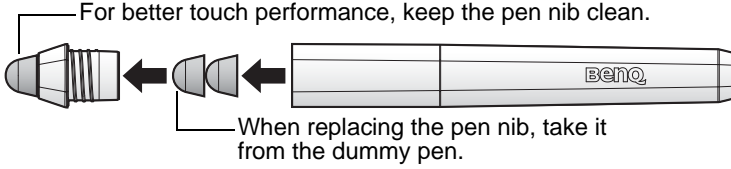

Product Overview

About Touch Module

Front View

Rear View

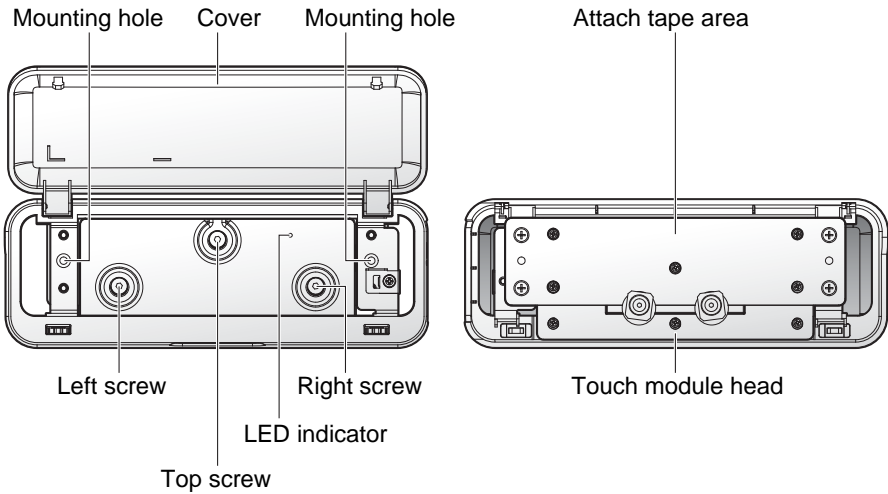

☞ Green LED: normal; orange LED: abnormal.

Right View

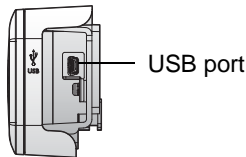

Dimensions

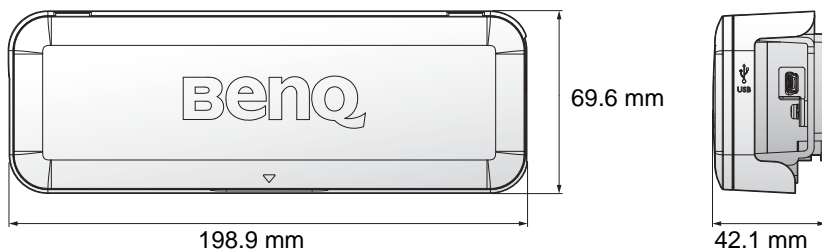

Preparation for Setup

Environment Condition

The touch module functions with an PointWrite interactive projector for scalable finger touch functionality, transforming any flat surface into a virtual interactive whiteboard.

For optimal finger touch quality, follow these guidelines:

1. Close all window curtains.
2. Select a projection area away from direct sunlight to prevent writing interference.
3. Keep infrared devices, such as: infrared microphones, away from the front side of the screen to prevent interference.
4. Remove accessories, such as: watches or necklaces, with a reflective surface to prevent interference.

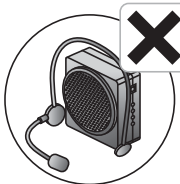
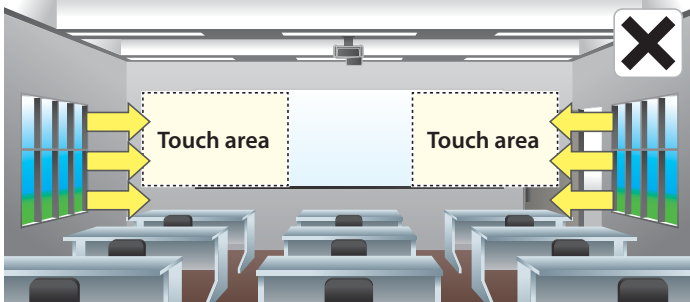
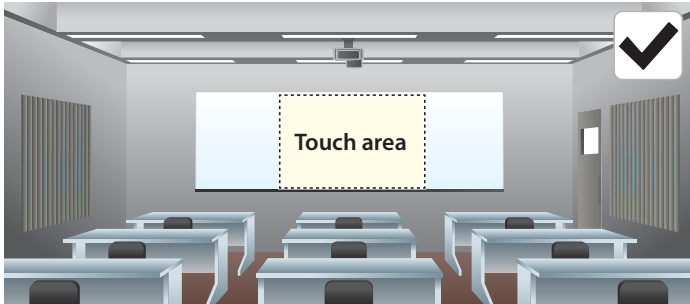

Surface Condition

Optimal finger touch quality is dependent on the selected surface condition. You can attach the touch module on a wall surface or existing board. It is important to choose a smooth and flat surface area free of protrusions.

- ☞ In the event of a projection surface not conducive to finger touch functionality, select the PointWrite pen as the pointing method for the classroom.

Selecting a Wall Surface

- Select a wall that is straight and flat, without any protruding objects on it.
- Writing directly on the wall with the pen can damage the wall. Test the wall surface by writing on it with the dummy pen before you install the touch module.

Using on the Wall Surface

Consider the following factors when selecting a wall surface to project your image onto:

- Project on a smooth, semi-gloss painted surface to reduce glare from the projector, to achieve optimal touch quality and to reduce wear on the pen nib.

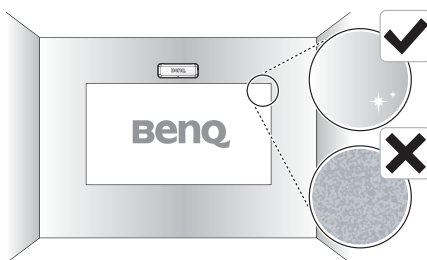

Using on a Dry-erase Board

- Attach a dry-erase board to the wall if you're projecting on a textured surface. A dry-erase board is a flat surface that works well with your interactive projector and allows you to write smoothly in digital ink.

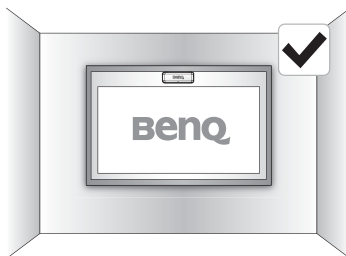

Measuring the Flatness of the Surface

1. Place a six-foot carpenter's level horizontally across the projection area (board).
2. Locate the point on the level furthest away from the projection area.
3. Measure the surface flatness on both sides of the projection area.

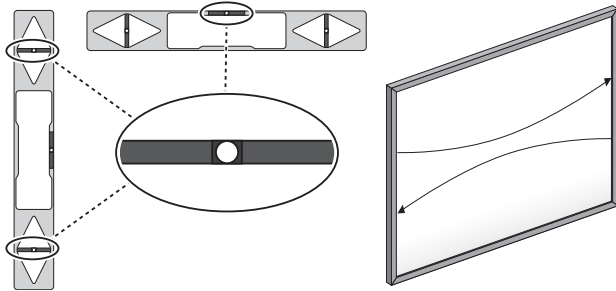

- Overall finger touch performance is influenced by the flatness of the projection surface.
- A flatness variance of 2mm in any direction ensures optimal finger touch performance.

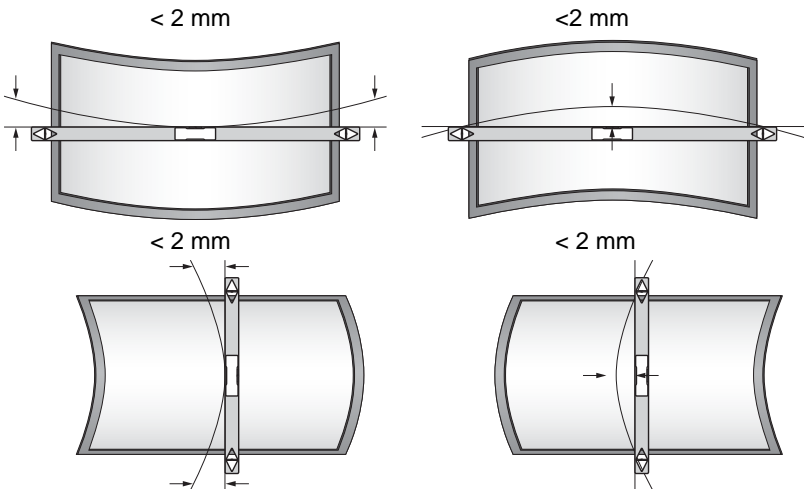

Surface Obstructions

Maintain the projection area clean and free of obstructions. The following are common obstruction examples:

- Cables or wires that hang into the projected image.

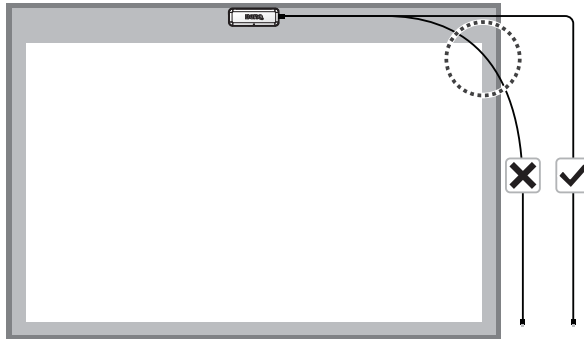

☞ Leave extra space between the cables and the projected image so you can make image adjustments later.

Projector Requirements

The PointWrite touch module is only available for BenQ PointWrite series interactive projector. Make sure the PointWrite camera module is installed properly before you setup the PointWrite touch module.

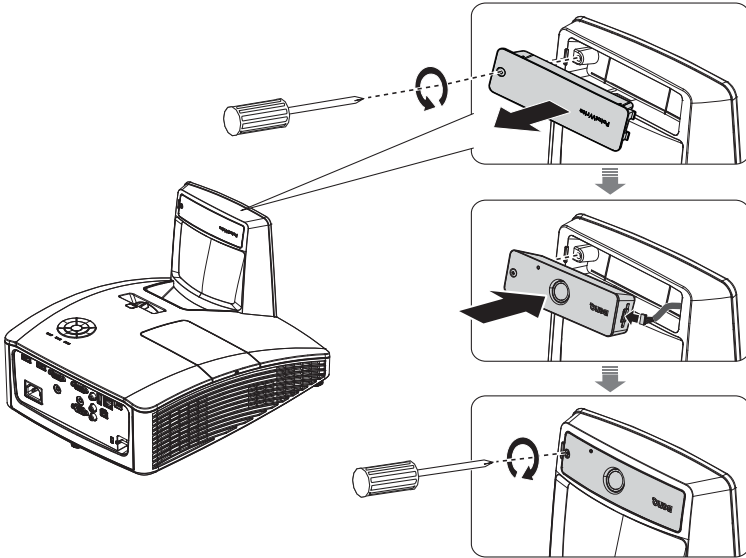

- ☞ For more information, please refer to the PointWrite camera module User Manual or Quick Guide when installing.
- To ensure the projector provides power to the PointWrite Touch module, turn on the USB Power Switch function in the OSD menu.
- PointWrite touch module is compatible with selected PointWrite camera module and projector.

Touch Module Installation

Screen Tolerance

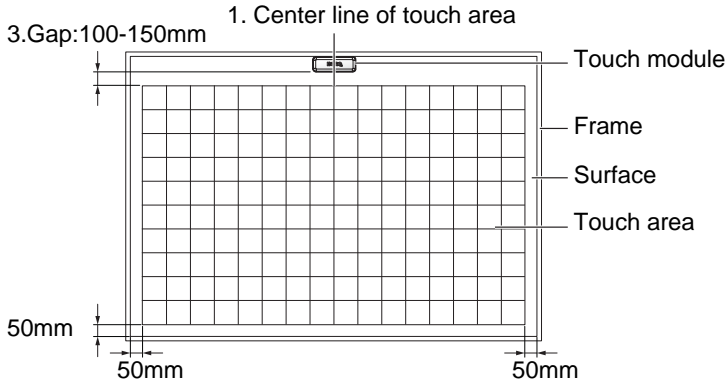

| # | Item | Specification |
|---|---------------------|--|
| 1 | Horizontal Position | Center line of touch area. |
| 2 | Vertical Position | Ceiling Mounting: Top of the screen with Gap. |
| 3 | Gap | Min: 100 mm, max: 150 mm |
| 4 | Orientation | Head of laser module should be face to touch screen. |
| 5 | Touch Area | Min: 65", max: 100" (without external lighting interference) |

☞ The ambient light or direct sun light may impact the screen size of touch area or cause interference.
In this case, make screen size smaller or turn to pen mode with PointWrite pen for better writing quality.

Mounting Touch Module

1. Attach the tape strip on the rear side of the PointWrite touch module.

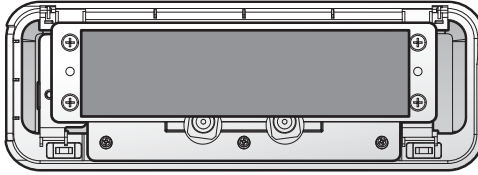

2. Follow the instructions above to position the touch module on the screen.

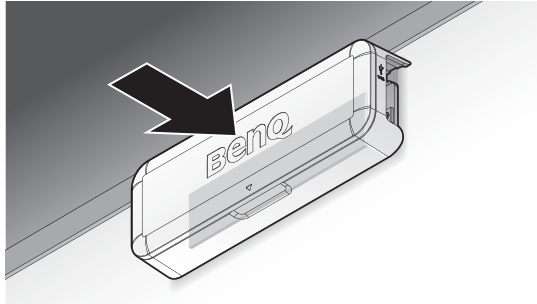

☞ 3M double tape (thickness: 1mm) is recommended.

3. Turn over the front cover.
4. Secure the touch module to the wall with screws.
5. Refer to page 17 to make sure the touch module is properly installed in the center of the projection screen.

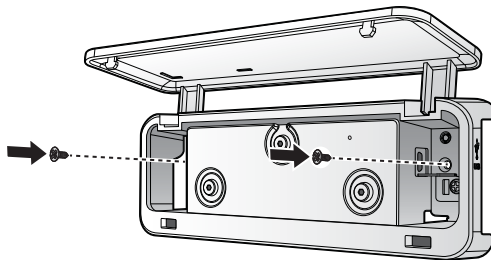

Driver Installation

When you are the first time to use this PointWrite Module, please install set-up driver for Configuration setting.

1. Please go to below BenQ Display Website to download PointWrite Set-up driver <https://business-display.benq.com/en/findproduct/projector/Accessory/pointwrite-pt20.html>
Go to BenQ Website >> Search PT20 >> Go to "Download Page".
2. Follow the on-screen instructions to install the driver.

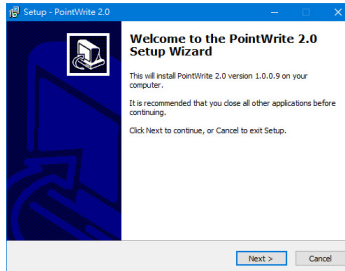

3. Complete the installation.

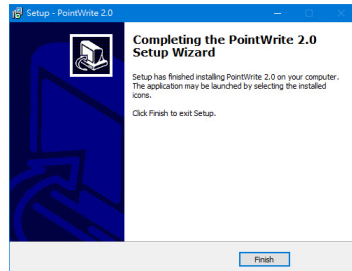
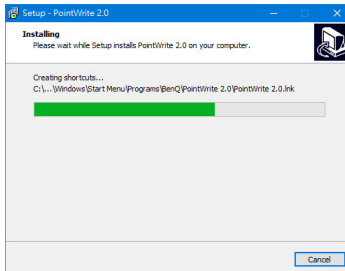

Driver Installation Complete

The PointWrite icon  will be created on the desktop.

The installation folder will be created on C: directory.

- 64-bit Windows: C:\Program Files (x86)\BenQ\PointWrite 2.0
- 32-bit Windows: C:\Program Files\BenQ\PointWrite 2.0

Remark:

Only First time using the PointWrite module need to install set-up driver for Configuration setting, the subsequent users can only plug the USB cable to connect to PC to start the interaction quickly without driver installation.

Connection

Connecting the PointWrite to PC

Use the USB cable¹ to connect the PointWrite to PC. Plug the USB mini-B end into the projector and plug the USB type-A end into PC.

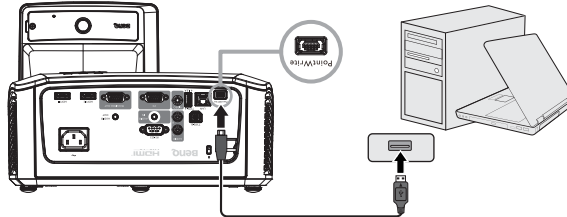

Check "Device Manager" from your computer to make sure that PointWrite device is recognized by your computer.

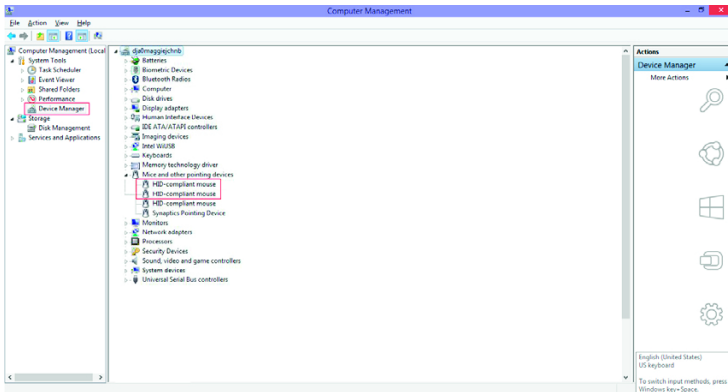

¹. A USB cable of 2 meters is provided. Use a USB repeater cable If you need to extend the length.

Connecting Touch Module

Use the USB cable to connect the touch module for power supply.

Connect Touch Module to Projector (Recommended)

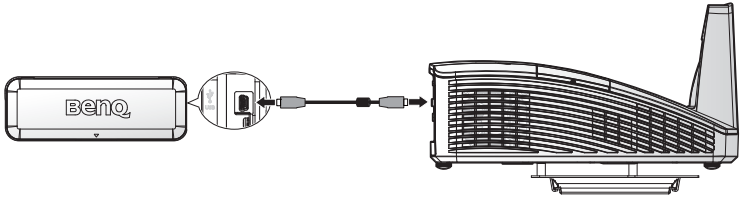

To prevent the connector from coming off, adjust the screw after inserting a USB cable.

1. Loosen the screw on the holder and move the holder down.

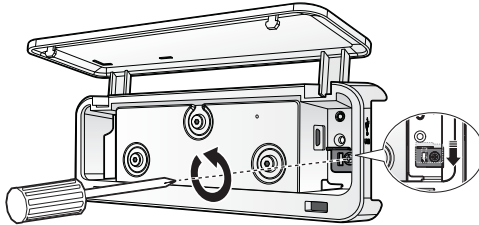

2. Insert a USB cable.
3. Move the holder up to holder the USB connector.
4. Secure the screw on the holder.

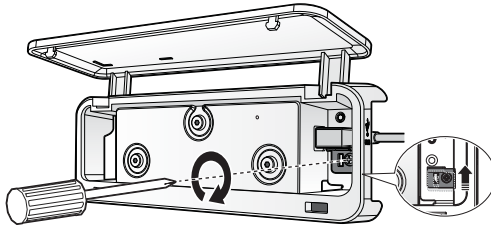

☞ USB type-A power is available for selected projector model.

5V USB adapter is not allowed!

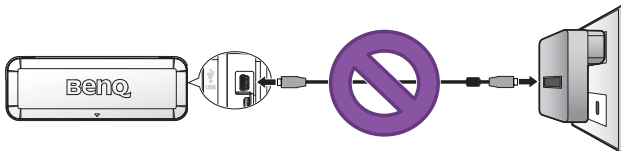

⚠ Charging of the device through an adapter is not recommended and may damage the touch module.

Configuration Setting

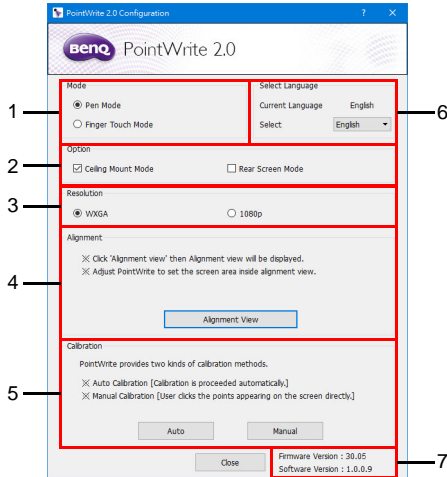

1. PointWrite Mode:

- **Pen Mode:** Default selection
- **Finger Touch Mode:** Only available when PointWrite Module works with BenQ PointWrite Touch module. When selecting Finger Touch mode, pen and finger can be used simultaneously.

2. PointWrite Option:

- **Ceiling Mount Mode:** Click this item if you mount the projector on the ceiling. When the projector is placed on the table, do not click this item.
- **Rear Screen Mode:** If the projector is installed on the rear screen system, click this item.

3. Resolution: Select Projector resolution.

4. PointWrite Alignment: See "[Alignment View](#)" on page 17.

5. PointWrite Calibration: See "[PointWrite Calibration](#)" on page 21.

6. PointWrite Language: The default language is the same as the language for your operating system. If you want to change the language, click on and then language list will display. **After selecting your preferred language, quit the PointWrite and start the PointWrite again.**

7. Information: Shows the camera firmware version.

 Select Finger Touch Mode during the setting process.

Alignment Instructions

Alignment View

The PointWrite Alignment function is to set the orientation of the PointWrite to the screen.

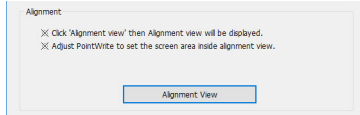

Alignment View: When clicking on the "Alignment View", the screen image is displayed on the alignment view as illustrated.

Ensure the touch module is in the middle of the screen and the triangle on the Alignment View is aligned with the touch module.





If the screen image is not in the center, the calibration will fail. Please make sure the PointWrite module is attached to the projector properly.

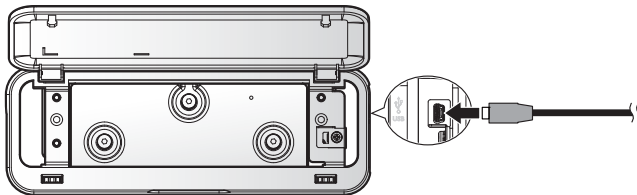

- Right side conflict
- Upper side conflict
- Left side conflict

Connect the USB cable for touch module and go to ["Adjustment for optimal height of Touch Module Laser Curtain" on page 20](#) for alignment instructions.



 To avoid active touching , please connect the USB cable after entering Alignment View.

Adjustment for Touch Module Laser Curtain

The laser curtain is a perfect plane to cover the screen in max fan angle of 180 degrees. The laser curtain is required to be parallel to the surface with the optimal gap for the effective finger touch performance.

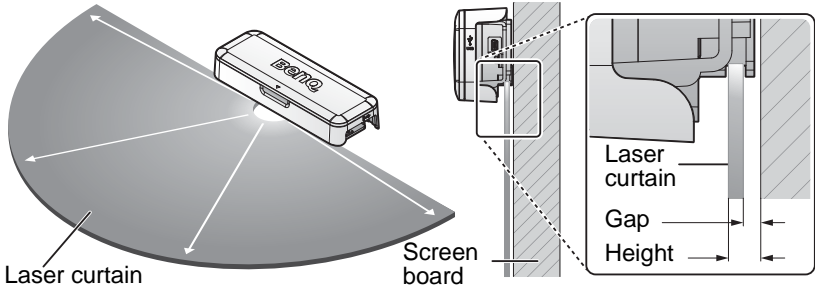

How to Adjust Touch Module Laser Curtain

To have the best performance of touch module, adjust the laser curtain using a hex key on the screws.

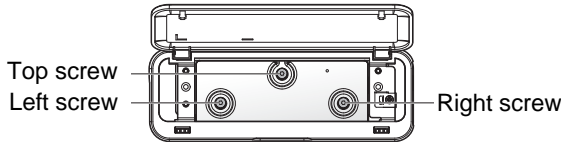

Pitching control

Adjust top screw, the laser curtain goes up and down as the following image.



Adjust left screw, the left side of laser curtain goes up and down as the following image.



Adjust right screw, the right side of laser curtain goes up and down as the following image.



1. Adjust reflection of Touch Module Laser Curtain horizontally.

Before Adjustment

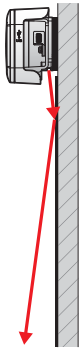

Left screw



Right screw



Left screw



Right screw

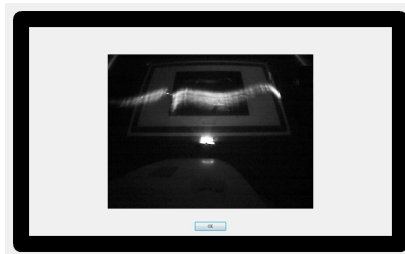
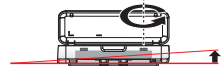

Top screw

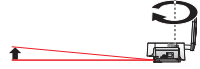

Adjust the reflection laser curtain horizontally

After Adjustment

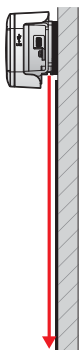

2. Adjustment for optimal height of Touch Module Laser Curtain
 The alignment masks help you to find the optimal height of the laser curtain and optimal touch performance.

- Using the Alignment Mark

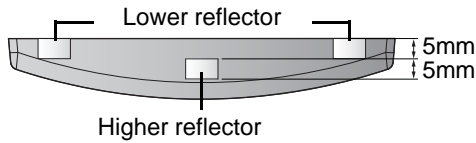

Mounting Position of Alignment Mark

In the camera view of PointWrite, The alignment mark reflector is shown like below picture.

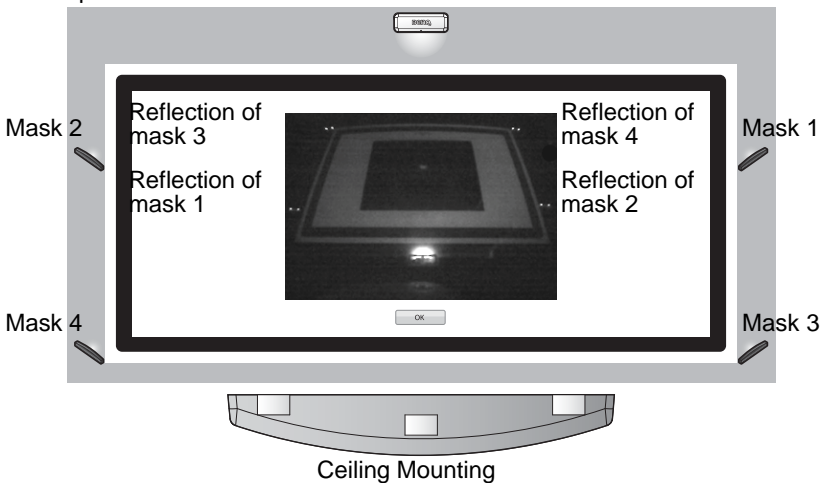

The number of bright spots reflected on the mask represents the height of the laser curtain:



| Reflected Points on the Mask | Height of Laser Curtain |
|------------------------------|-------------------------|
| 1 point | 5 - 10 mm |
| 2 points | < 5 mm |
| 3 points | Around 5 mm |

We recommend the number of highlights on each mask as the following table:

| | Attached Position | Suggested Reflected Points on the Mask |
|-----------|---------------------------|--|
| Mask 1, 2 | Upper side of the screen | 3 points |
| Mask 3, 4 | Bottom side of the screen | 3 points |

☞ Adjust the height of the laser curtain depending the difference installation environment.

PointWrite Calibration

PointWrite provides two kinds of calibration methods: auto calibration and manual calibration.

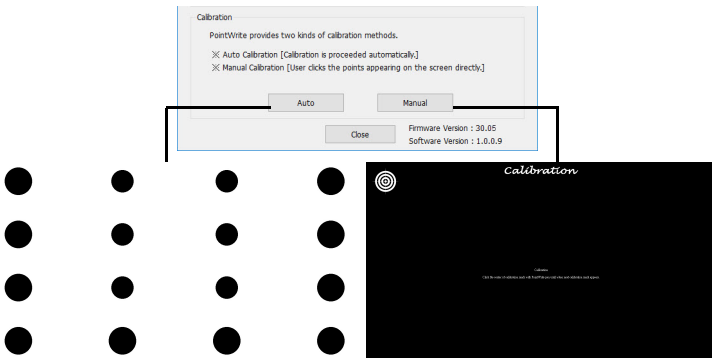

Auto calibration: Click on and the calibration process will run automatically.

When you choose this method, white image is shown on the screen and the pattern image is displayed.

Manual calibration: Click on and calibration window will be projected on the screen.

Use the PointWrite pen to click  on the center of calibration cursor immediately after it appears. Then the next cursor will display. Repeat this process until the last calibration cursor disappears.

⚠ **Caution:** In rare circumstances, auto calibration may fail or accuracy may be low. In this case, please execute the manual calibration.



Specifications

| Touch module | |
|-----------------------|-------------------------------------|
| Model Name | PT20 |
| Operating Voltage | 4.8 ~ 5.2V |
| Power Consumption | Max 500 mA |
| USB Type (Power) | Mini USB B type |
| Power Source | Power via USB type A from projector |
| USB Cable Distance | Max 2 meters |
| Wavelength | 940 nm ± 15 nm |
| Fan Angle | Max : 180° (2 laser beams) |
| Rolling Control Range | Max 4° |
| Pitch Control Range | Max 9° |
| Safety | Class 1 |
| Dimension | 198.9 x 69.6 x 42.1 mm |
| Weight | 238 g (with cover) |

| General function | |
|-------------------------|--|
| Camera Type | Selected series of PointWrite camera module (PW30U, PW40U) |
| Multi Pen Supported | Up to 10 touch points (Pen/Finger) |
| Response Time | 0.016 sec |
| Refresh Rate | 60 Frames/sec |
| Calibration | Auto / Manual |
| Dual screen Calibration | Yes |

| Environment Specification | |
|----------------------------------|---|
| Storage Temperature | -20°C ~ 60°C (-4°F ~ 140°F) Humidity: 10% ~ 90% RH |
| Operation Temperature | 0°C ~ 40°C (32°F ~ 104°F) Humidity: 10% ~ 90% RH |

 Dual screen requires another dual screen driver, which can be download on product web page.