

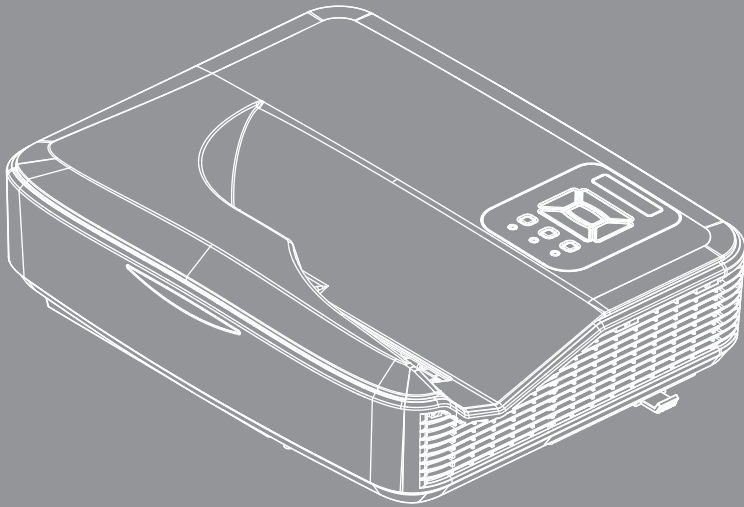

# DLP® Projector



User manual

**HDMI**™  
HIGH DEFINITION MULTIMEDIA INTERFACE



**DLP**®  
TEXAS INSTRUMENTS

# Table of Contents

Table of Contents .....	2	<i>Interactive</i> .....	46
Usage Notice .....	3	Appendices .....	56
<i>Safety Information</i> .....	3	<i>Compatibility Modes</i> .....	56
<i>Precautions</i> .....	4	<i>Ceiling Mount Installation</i> .....	60
<i>Regulation &amp; Safety Notices</i> .....	6	<i>Manual Warp Control Instruction</i> .....	61
Introduction .....	9	<i>Optoma global offices</i> .....	69
<i>Package Overview</i> .....	9		
<i>Product Overview</i> .....	10		
<i>Main Unit</i> .....	10		
<i>Control Panel</i> .....	11		
<i>Input/Output Connections</i> .....	12		
<i>Remote Control</i> .....	13		
Installation .....	15		
<i>Connecting the Projector</i> .....	15		
<i>Connect to Computer/Notebook</i> .....	15		
<i>Connect to Video Sources</i> .....	16		
<i>Powering the Projector On / Off</i> .....	17		
<i>Powering On the Projector</i> .....	17		
<i>Powering Off the Projector</i> .....	18		
<i>Warning Indicator</i> .....	18		
<i>LED Lighting Message</i> .....	19		
<i>Adjusting the Projected Image</i> .....	20		
<i>Adjusting the Projector's Height</i> .....	20		
<i>Adjusting the Projector's Focus</i> .....	21		
<i>Adjusting Projection Image Size</i> <i>(Diagonal)</i> .....	22		
User Controls .....	25		
<i>Control Panel &amp; Remote Control</i> .....	25		
<i>Control Panel</i> .....	25		
<i>Structure</i> .....	26		
<i>On-screen Display Menus</i> .....	31		
<i>How to operate</i> .....	31		
<i>Picture</i> .....	32		
<i>Screen</i> .....	34		
<i>Setting</i> .....	37		
<i>Volume</i> .....	39		
<i>Options</i> .....	40		
<i>Options   Laser Settings</i> .....	42		
<i>3D</i> .....	43		
<i>LAN</i> .....	44		

# Usage Notice

## Safety Information

	The lightning flash with arrow head within an equilateral triangle is intended to alert the user to the presence of uninsulated "dangerous voltage" within the product's enclosure that may be of sufficient magnitude to constitute a risk of electric shock to persons.
	The exclamation point within an equilateral triangle is intended to alert the user to the presence of important operating and maintenance (servicing) instructions in the literature accompanying the appliance.

**WARNING:** TO REDUCE THE RISK OF FIRE OR ELECTRIC SHOCK, DO NOT EXPOSE THIS APPLIANCE TO RAIN OR MOISTURE. DANGEROUS HIGH VOLTAGES ARE PRESENT INSIDE THE ENCLOSURE. DO NOT OPEN THE CABINET. REFER SERVICING TO QUALIFIED PERSONNEL ONLY.

### Class B emissions limits

This Class B digital apparatus meets all requirements of the Canadian Interference-Causing Equipment Regulations.

### Important Safety Instruction

1. Do not block any ventilation openings. To ensure reliable operation of the projector and to protect from over heating, it is recommended to install the projector in a location that does not block ventilation. As an example, do not place the projector on a crowded coffee table, sofa, bed, etc. Do not put the projector in an enclosure such as a book case or a cabinet that restricts air flow.
2. Do not use the projector near water or moisture. To reduce the risk of fire and/or electric shock, do not expose the projector to rain or moisture.
3. Do not install near heat sources such as radiators, heaters, stoves or any other apparatus such as amplifiers that emits heat.
4. Clean only with dry cloth.
5. Only use attachments/accessories specified by the manufacturer.
6. Do not use the unit if it has been physically damaged or abused.  
Physical damage/abuse would be (but not limited to):
  - Unit has been dropped.
  - Power supply cord or plug has been damaged.
  - Liquid has been spilled on to the projector.
  - Projector has been exposed to rain or moisture.
  - Something has fallen in the projector or something is loose inside.Do not attempt to service the unit yourself. Opening or removing covers may expose you to dangerous voltages or other hazards.
7. Do not let objects or liquids enter the projector. They may touch dangerous voltage points and short out parts that could result in fire or electric shock.
8. See projector enclosure for safety related markings.
9. The unit should only be repaired by appropriate service personnel.

# Usage Notice

## Precautions



*Please follow all warnings, precautions and maintenance as recommended in this user's guide.*

- Warning - Do not look into the projector's lens when the light source is on. The bright light may hurt and damage your eyes.
  
- Warning - To reduce the risk of fire or electric shock, do not expose this projector to rain or moisture.
  
- Warning - Please do not open or disassemble the projector as this may cause electric shock.



# Usage Notice

## **Do:**

- ❖ Turn off and unplug the power plug from the AC outlet before cleaning the product.
- ❖ Use a soft dry cloth with mild detergent to clean the display housing.
- ❖ Disconnect the power plug from AC outlet if the product is not being used for a long period of time.

## **Do not:**

- ❖ Block the slots and openings on the unit provided for ventilation.
- ❖ Use abrasive cleaners, waxes or solvents to clean the unit.
- ❖ Use under the following conditions:
  - In extremely hot, cold or humid environments.
    - ▶ Sea level to 6000 feet  
Extremely hot: > 35°C  
Extremely cool: < 5°C
    - ▶ 6000 feet above  
Extremely hot: > 30°C  
Extremely cool: < 5°C
    - ▶ Extremely humid: > 70% R.H. (Relative Humidity)
  - In areas susceptible to excessive dust and dirt.
  - Near any appliance generating a strong magnetic field.
  - In direct sunlight.

# Usage Notice

## Regulation & Safety Notices

*This appendix lists the general notices of your projector.*

### **FCC notice**

This device has been tested and found to comply with the limits for a Class B digital device pursuant to Part 15 of the FCC rules. These limits are designed to provide reasonable protection against harmful interference in a residential installation. This device generates, uses and can radiate radio frequency energy and, if not installed and used in accordance with the instructions, may cause harmful interference to radio communications.

However, there is no guarantee that interference will not occur in a particular installation. If this device does cause harmful interference to radio or television reception, which can be determined by turning the device off and on, the user is encouraged to try to correct the interference by one or more of the following measures:

- Reorient or relocate the receiving antenna.
- Increase the separation between the device and receiver.
- Connect the device into an outlet on a circuit different from that to which the receiver is connected.
- Consult the dealer or an experienced radio/television technician for help.

### **Notice: Shielded cables**

All connections to other computing devices must be made using shielded cables to maintain compliance with FCC regulations.

### **Caution**

Changes or modifications not expressly approved by the manufacturer could void the user's authority, which is granted by the Federal Communications Commission, to operate this projector.

# Usage Notice

## Operation conditions

This device complies with Part 15 of the FCC Rules. Operation is subject to the following two conditions:

1. This device may not cause harmful interference and
2. This device must accept any interference received, including interference that may cause undesired operation.

## Notice: Canadian users

This Class B digital apparatus complies with Canadian ICES-003.

## Remarque à l'intention des utilisateurs canadiens

Cet appareil numérique de la classe B est conforme à la norme NMB-003 du Canada.

## Declaration of Conformity for EU countries

- EMC Directive 2004/30/EC (including amendments)
- Low Voltage Directive 2014/35/EU
- R & TTE Directive 2014/53/EU (if product has RF function)

### Disposal instructions



Do not throw this electronic device into the trash when discarding. To minimize pollution and ensure utmost protection of the global environment, please recycle it.

# Usage Notice

## Safety notice

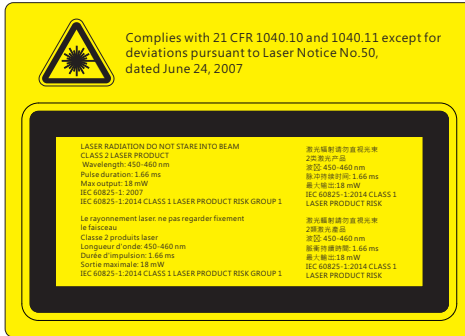

- This projector is a Class 2 laser device that conforms with IEC 60825-1:2007 and CFR 1040.10 and 1040.11.
- Class 2 laser product, Do Not Stare Into Beam.
- This projector has built-in Class 4 laser module. Disassembly or modification is very dangerous and should never be attempted.
- Any operation or adjustment not specifically instructed by the user's guide creates the risk of hazardous laser radiation exposure.
- Do not open or disassemble the projector as this may cause damage by the exposure of laser radiation.
- Do not stare into beam when the projector is on. The bright light may result in permanent eye damage.
- Without following the control, adjustment or operation procedure may cause damage by the exposure of laser radiation.
- Adequate instructions for assembly, operation, and maintenance, including clear warnings concerning precautions to avoid possible exposure to laser and collateral radiation in excess of the accessible emission limits in Class 2.
- IEC 60825-1: 2014 CLASS 1 LASER PRODUCT RISK GROUP 1.

# Introduction

## Package Overview

*Unpack and inspect the box contents to ensure all parts listed below are in the box. If something is missing, please contact your nearest customer service center.*



- \*For European warranty information please visit [www.optomaeurope.com](http://www.optomaeurope.com)

Optional accessories vary depending on model, specification and region.

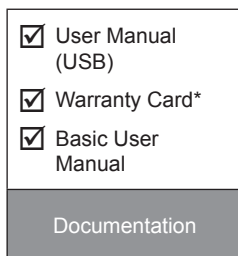
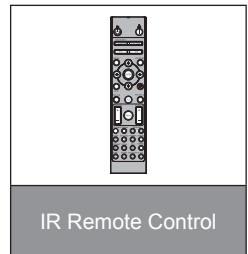
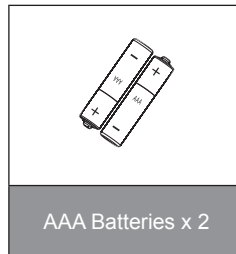
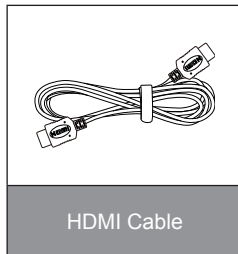
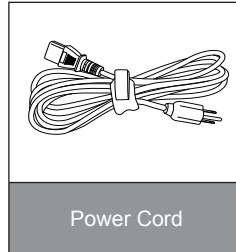
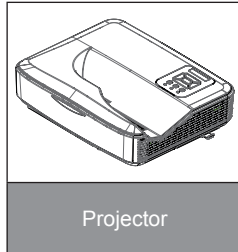

# Introduction

## Product Overview

### Main Unit

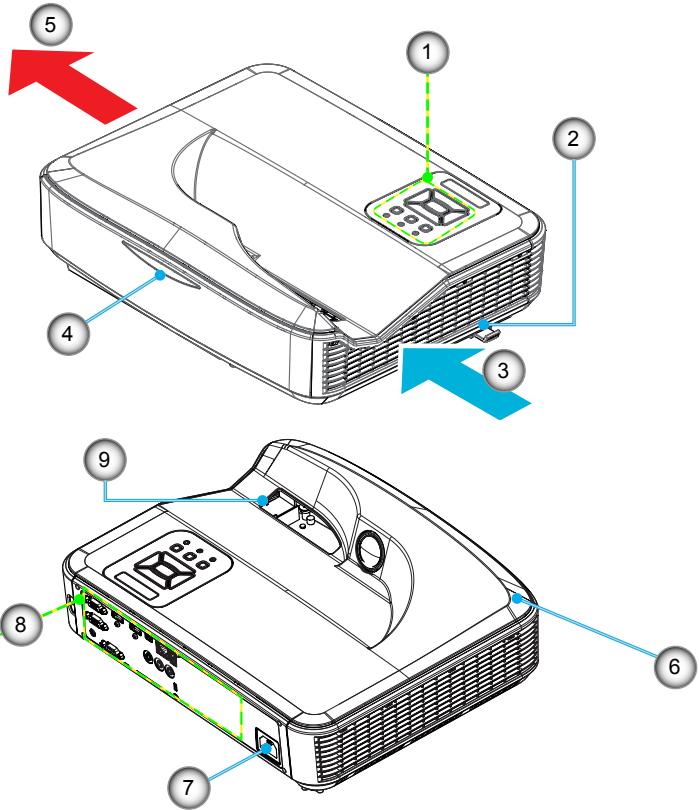

- ❖ The interface is subject to model's specifications.
- ❖ Do not block projector in/out air vents and keep a minimum 30cm distance.

- |                         |                               |
|-------------------------|-------------------------------|
| 1. Control Panel        | 6. Speaker                    |
| 2. Focus Switch         | 7. Power Socket               |
| 3. Ventilation (inlet)  | 8. Input / Output Connections |
| 4. IR Receiver          | 9. Lens                       |
| 5. Ventilation (outlet) |                               |

## Control Panel

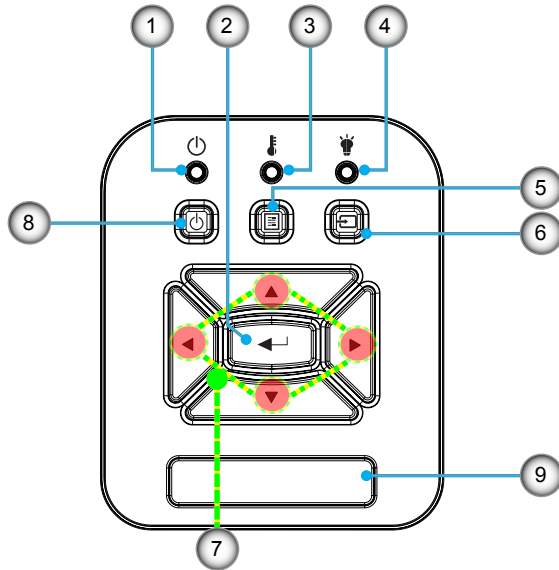

1. Power LED
2. Enter
3. Temp LED
4. Light source LED
5. Menu
6. Input
7. Four Directional Select Keys
8. Power/Standby button
9. IR Receiver

# Introduction

## Input/Output Connections

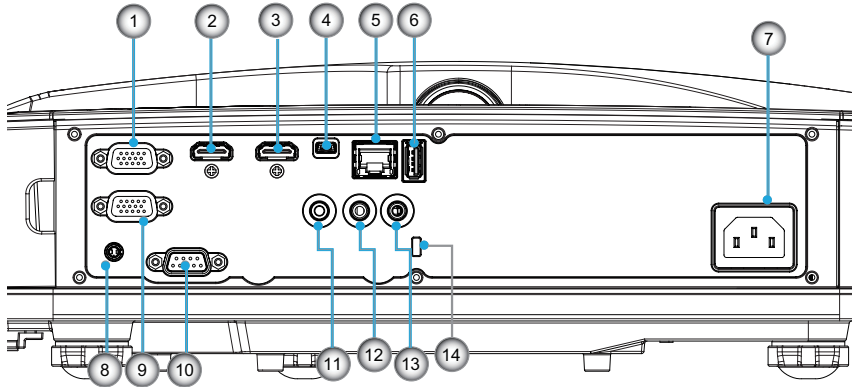

- ❖ The interface is subject to model's specifications.



- ❖ Monitor loop through only support in VGA-In/YPbPr.

No	Item
1.	VGA-IN / YPbPr connector
2.	HDMI2 Input connector
3.	HDMI1 Input connector
4.	USB-B mini connector (Firmware upgrade)
5.	RJ-45 / HDBaseT Input connector
6.	USB Power Out (1.5A) connector
7.	Power socket
8.	Interactive connector
9.	VGA-OUT connector
10.	RS-232C connector
11.	AUDIO OUT connector
12.	AUDIO IN connector
13.	Microphone connector
14.	Kensington™ Lock Port



# Introduction

## Remote Control

No	Item
1.	Power On Power on the projector.
2.	Geometric Correction Launch the Geometric Correction menu.
3.	F1:Test pattern Display a test pattern.
4.	Display Mode Select the display mode.
5.	Four directional select keys To select items or make adjustments. <ul style="list-style-type: none"> <li>• Up</li> <li>• Down</li> <li>• Left</li> <li>• Right</li> </ul>
6.	Information Display the projector information.
7.	F3:Color Matching Launch the Color Matching setting menu.
8.	Input source selection Select an input signal.
9.	Menu Launch the OSD menu. To exit OSD, Press "Menu" again.
10.	Volume Control +/- Increase/decrease the volume. + Increase the volume. - Decrease the volume.
11.	Freeze Freeze the projected image.
12.	Format Choose the projector format.

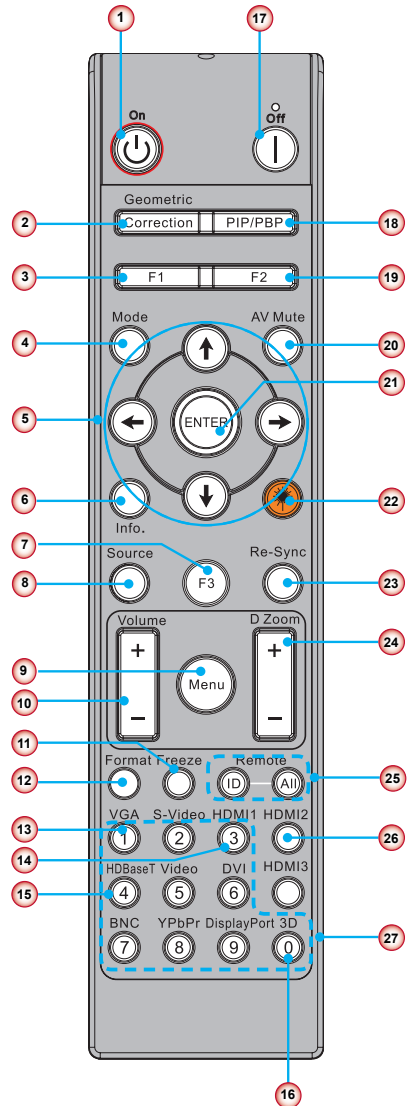

# Introduction



❖ Some keys may have no function for models that do not support these features.

No	Item
13.	VGA Switch to VGA source.
14.	HDMI1 Switch to HDMI1 source.
15.	HDBaseT (Depending on Model) Switch to HDBaseT source.
16.	3D Switch to 3D source.
17.	Power Off Power off the projector.
18.	PIP/PBP Menu Launch the PIP/PBP menu.
19.	F2:LAN Settings Launch the LAN Setting Menu.
20.	AV Mute Momentarily turns off/on the audio and video.
21.	Enter Confirm your item selection.
22.	Laser Use as laser pointer.
23.	Re-Sync Automatically synchronize the projector to the input source.
24.	Digital Room +/- <ul style="list-style-type: none"><li>• + Zoom in the projected image.</li><li>• - Zoom out the projected image.</li></ul>
25.	Remote ID / Remote all Set the remote control ID.
26.	HDMI2 Switch to HDMI2 source.
27.	Number Keypad (0~9) Use as numeric keypad number "0~9".

# Installation

## Connecting the Projector Connect to Computer/Notebook

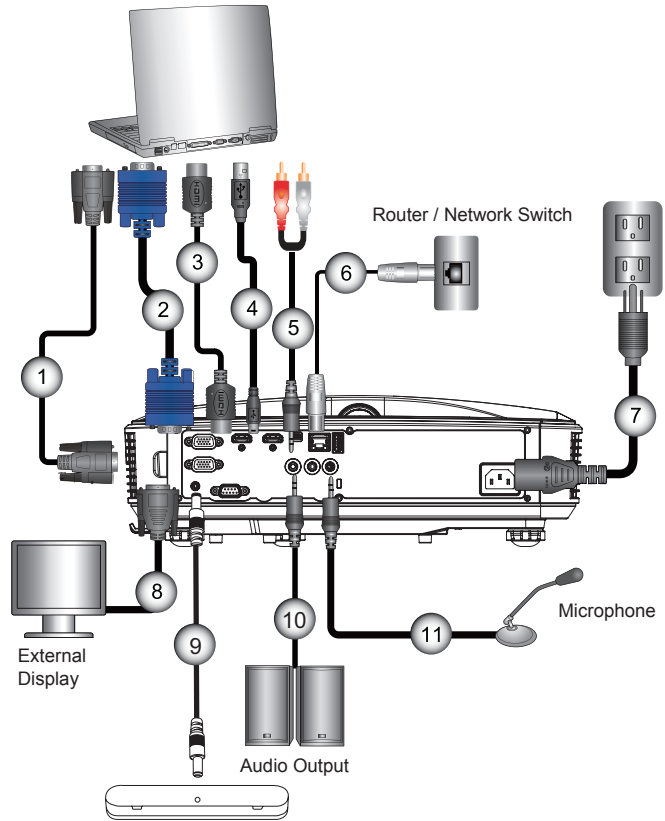

- ❖ Due to the difference in applications for each country, some regions may have different accessories.
- ❖ (\*) Optional accessory

1.....	*RS232 Cable
2.....	.....VGA Cable
3.....	*HDMI Cable
4.....	*USB Cable
5.....	*Audio Cable/RCA
6.....	*RJ45 Cable
7.....	.....Power Cord
8.....	*VGA Output Cable
9.....	.....DC to DC Cable
10.....	*Audio Output Cable
11.....	*Audio Input Cable

# Installation

## Connect to Video Sources

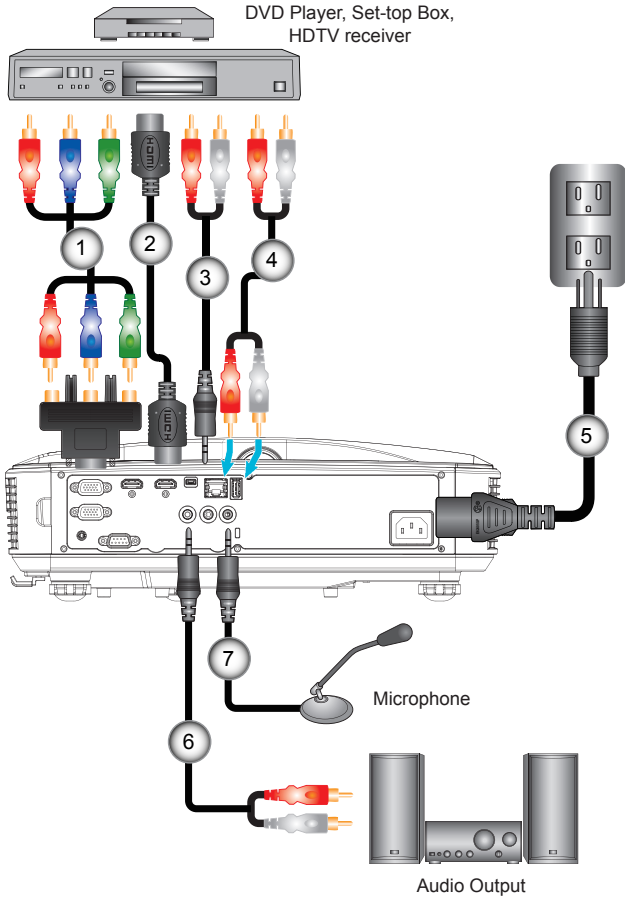

- ❖ Due to the difference in applications for each country, some regions may have different accessories.
- ❖ (\*) Optional accessory

1.....	*15-Pin to 3 RCA Component/HDTV Adaptor
2.....	*HDMI Cable
3.....	*Audio Cable/RCA
4.....	*Audio Cable
5.....	Power Cord
6.....	*Audio Cable/RCA
7.....	*Audio Input Cable

## Powering the Projector On / Off

### Powering On the Projector

1. Securely connect the power cord and signal cable. When connected, the POWER/STANDBY LED will turn Orange.
2. Turn on the light source by pressing “**⏻**” button either on the projector or on the remote. At this moment, the POWER/STANDBY LED will now turn Blue. **①**

The startup screen will display in approximately 10 seconds. The first time you use the projector, you will be asked to select the preferred language and power saving mode.

3. Turn on and connect the source that you want to display on the screen (computer, notebook, video player, etc). The projector will detect the source automatically. If not, push menu button and go to “OPTIONS”. Make sure that the “Source Lock” has been set to “Off”.
- ❖ If you connect multiple sources at the same time, press the “INPUT” button on the control panel or direct source keys on the remote control to switch between inputs.



❖ When the power mode is in standby mode (power consumption < 0.5W), the VGA output/ input and audio will be deactivated when the projector is in standby.



❖ Turn on the projector first and then select the signal sources.

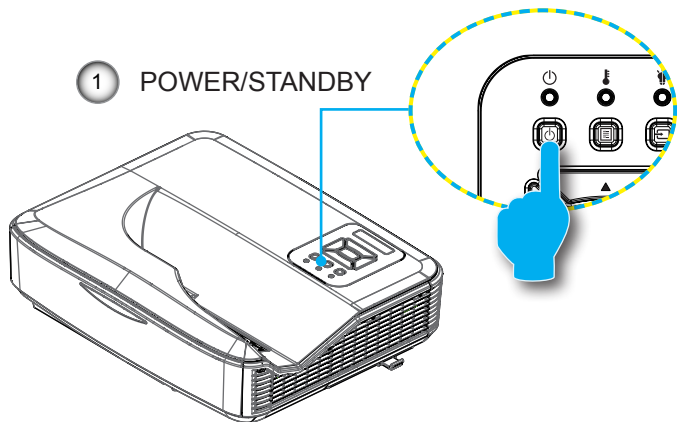



# Installation

## Powering Off the Projector

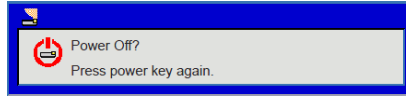
1. Press the “” button on the remote control or on the control panel to turn off the projector. The following message will be displayed on the screen.



Press the “” button again to confirm otherwise the message will disappear after 10 seconds. When you press the “” button for the second time, the fan will start cooling the system and will shut down.

2. The cooling fans continue to operate for about 4 seconds for cooling cycle and the POWER/STANDBY LED will flash Orange. When the POWER/STANDBY LED lights solid Orange, the projector has entered standby mode.

If you wish to turn the projector back on, you must wait until the projector has completed the cooling cycle and has entered standby mode. Once in standby mode, simply press “” button to restart the projector.

3. Disconnect the power cord from the electrical outlet and the projector.

## Warning Indicator

When the warning indicators (see below) come on, the projector will automatically shutdown:



- ❖ Contact the nearest service center if the projector displays these symptoms.

- ❖ “LIGHT SOURCE” LED indicator is lit red and if “POWER/STANDBY” indicator flashes amber.
- ❖ “TEMP” LED indicator is lit red, this indicates the projector has overheated. Under normal conditions, the projector can be switched back on.
- ❖ “TEMP” LED indicator flashes red and if “POWER/STANDBY” indicator flashes amber.

Unplug the power cord from the projector, wait for 30 seconds and try again. If the warning indicator light up again, please contact your nearest service center for assistance.

## LED Lighting Message



-- : No light

On: Steady light

FLASH: 1s

FLASH (FAST): 500ms

FLASH (SLOW): 3s

Lighting Message \ Status	Power Red	Power Blue	Temp	Light source
STANDBY	ON	--	--	--
POWER ON	--	ON	--	--
WARNING UP STATE	FLASH	--	--	--
BURNIN ON	FLASH	FLASH	--	--
BURNIN OFF	FLASH	FLASH	--	--
Scalar DownloadMode	ON	ON	ON	ON
Error Status				
POWERGOOD NG	--	--	ON	ON
FAN LOCK	--	--	FLASH (SLOW)	--
CW BREAKDOWN	--	--	FLASH (FAST)	--
OVERHEAT	--	--	ON	--
LD OVERHEAT	--	--	ON	--
LD VOLTAGE ERR	--	--	--	ON

# Installation

## Adjusting the Projected Image

### Adjusting the Projector's Height

*The projector is equipped with adjustable feet for adjusting the image height position.*

1. Locate the foot you want to adjust on the underside of the projector.
2. Turn the adjustable foot counter-clockwise to move it outwards or clockwise to move it inwards. Repeat with the remaining feet as needed.

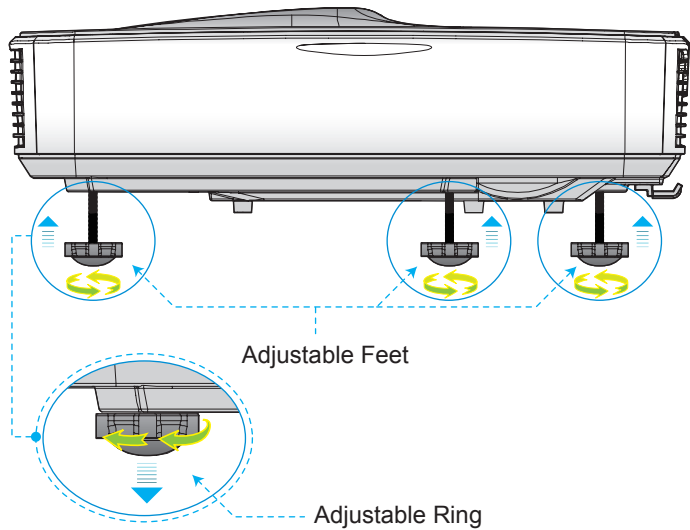



# Installation

## Adjusting the Projector's Focus

To focus the image, slide the focus switch to left/right until the image is clear.

- ▶ 1080p series: The projector will focus at distances (lens to wall) from 1.59~1.87 feet (0.49~0.57 meters)

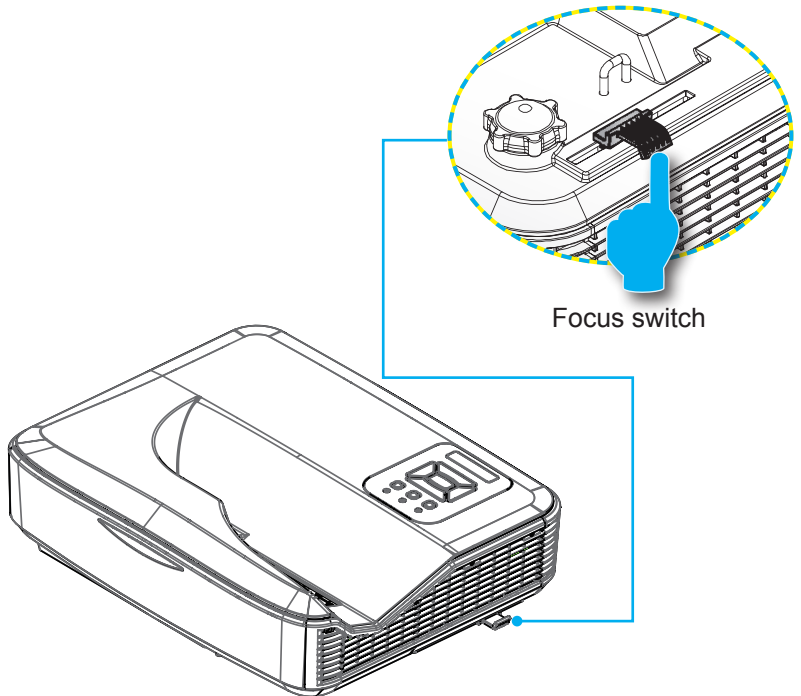

# Installation

## Adjusting Projection Image Size (Diagonal)

- ▶ 1080p series: Projection Image Size from 87" to 102" (2.21 to 2.59 meters).

### Projector installation measurement chart Wall Mount

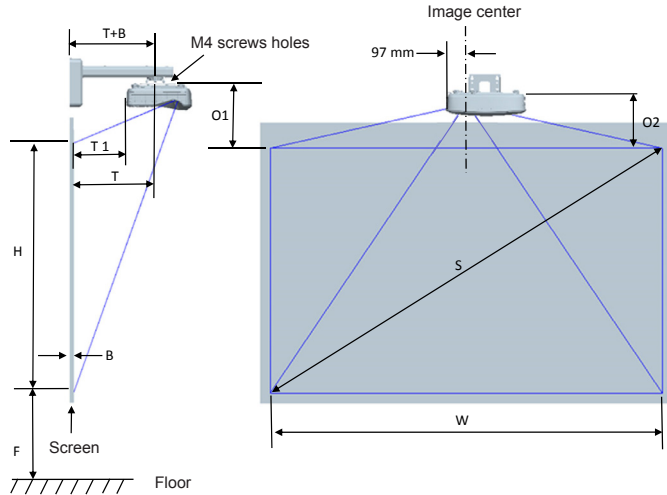

# Installation

❖ This table is for user's reference only.

1080P (16:9) Wall mount installation measurement chart							
Diagonal image size (S) in inch	Diagonal image size (S) in mm	Image width (W) in mm	Image height (H) in mm	Distance from surface of whiteboard to center of projector mount (T) in mm	Distance from surface of whiteboard to back of projector (T1) in mm	Distance from top of image to top of interface boss (O1) in mm	Distance from top of image to top of projector (O2) in mm
87	2210	1926	1083	370	233	288	268
88	2235	1948	1096	376	239	291	271
89	2261	1970	1108	382	245	294	274
90	2286	1992	1121	387	250	296	276
91	2311	2015	1133	393	256	299	279
92	2337	2037	1146	398	261	301	281
93	2362	2059	1158	404	267	304	284
94	2388	2081	1171	409	272	307	287
95	2413	2103	1183	415	278	309	289
96	2438	2125	1196	421	284	312	292
97	2464	2147	1208	426	289	314	294
98	2489	2170	1220	432	295	317	297
99	2515	2192	1233	437	300	320	300
100	2540	2214	1245	443	306	322	302
101	2565	2236	1258	448	311	325	305
102	2591	2258	1270	454	317	327	307

# Installation

## Projector installation measurement chart Table Mount

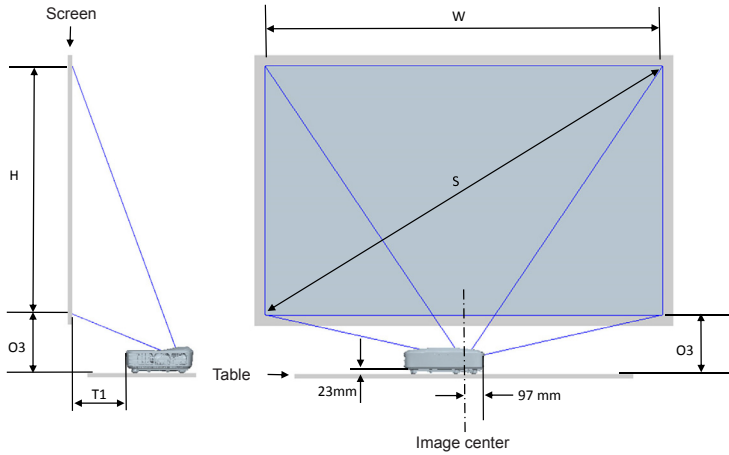

❖ This table is for user's reference only.









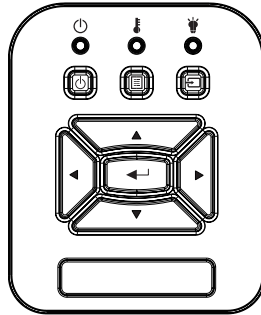

1080P (16:9) Table mount installation measurement chart					
Diagonal image size (S) in inch	Diagonal image size (S) in mm	Image width (W) in mm	Image height (H) in mm	Distance from surface of whiteboard to back of projector (T1) in mm	Distance from bottom of image to top of table (O3) in mm
87	2210	1926	1083	233	291
88	2235	1948	1096	239	294
89	2261	1970	1108	245	297
90	2286	1992	1121	250	299
91	2311	2015	1133	256	302
92	2337	2037	1146	261	304
93	2362	2059	1158	267	307
94	2388	2081	1171	272	310
95	2413	2103	1183	278	312
96	2438	2125	1196	284	315
97	2464	2147	1208	289	317
98	2489	2170	1220	295	320
99	2515	2192	1233	300	323
100	2540	2214	1245	306	325
101	2565	2236	1258	311	328
102	2591	2258	1270	317	330

# User Controls

## Control Panel & Remote Control

### Control Panel



Name	Description
POWER 	Refer to the “Power On/Off the Projector” section.
Enter 	Confirm a selected item.
INPUT 	Select an input signal
MENU 	Launch the on-screen display (OSD) menu. To exit OSD, press “MENU” again.
Four Directional Select Keys	Use     to select items or make adjustments to your selection.
Light Source LED 	Refer to the LED indicator of the projector light source status.
TEMP LED 	Refer to the LED indicator of the projector temperature status.
ON/STANDBY LED 	Refer to the LED indicator of the projector power status.

# User Controls

## Structure

Main Menu	Sub Menu	Setting		Notes
Picture	Color Mode	Bright		Independent of Signal Type
		Presentation		
		Movie		
		Game		
		Blending		
		User		
	Wall Color	White		
		Light Yellow		
		Light Blue		
		Pink		
		Dark Green		
	Brightness			Change Color Mode to User Mode if customer changes the settings
	Contrast			Change Color Mode to User Mode if customer changes the settings
	Sharpness			Change Color Mode to User Mode if customer changes the settings
	Saturation			1. Change Color Mode to User Mode if customer changes the settings 2. Only support video signal from VGA
	Hue			1.Change Color Mode to User Mode if customer changes the settings 2.Only support video signal from VGA
	Gamma			Change Color Mode to User Mode if customer changes the settings
Color Temp			Independent of Color Mode	
Color Setting	Red/Green/Blue/ Cyan/Magenta/ Yellow	Hue	Change Color Mode to User Mode if customer changes the settings	
		Saturation		
		Gain		
	White	Red Gain		
		Green Gain		
	Blue Gain			

# User Controls

Screen	Aspect Ratio	Auto			
		4:3			
		16:9			
		16:10			
	Phase				
	Clock			may differnet every time resync	
	H.Position				
	V.Position				
	Digital Zoom			0: means 1X, 2 means 2X	
	Projection	Front			
		Front Ceiling			
		Rear			
		Rear Ceiling			
	Geometric Correction	H. Keystone			
		V. Keystone			
		Warp Control	Off/ Manual/ Auto	Gray out if 3D On	
		Warp Sharpness			
		Warp Number	2x2/ 3x3/ 5x5/ 9x9/ 17x17	Gray out if Warp Control=Off or PC	
		Warp Inner	Off/ On	Gray out if Warp Control=Off or PC Gray out if Warp Number=2x2	
		Blend Setting	Left		Gray out if Warp Control=Off or PC
			Right		
			Top		
			Bottom		
		Blend Gamma			
	Grid Color	Green/ Purple/ Red/ Cyan	Gray out if Warp Control=Off or PC		
	Reset	Yes/ No	Keep Warp Control and Grid Color		
	PIP-PBP Settings	Function	PIP/ PBP/ Off		
		Main Source	VGA/ HDMI-1/ HDMI-2/ HDBaseT	Main and Sub Source can be the same	
		Sub Source	VGA/ HDMI-1/ HDMI-2/ HDBaseT		
		H Position			
V Position					
Size		Small/ Medium/ Large			
Swap					

# User Controls

Settings	Language	English German French Italian Spanish Polish Swedish Dutch Portugese Japanese Traditional Chinese Simplified Chinese Korean Russian Arabic Norsk Turkish Danish		
	Menu Location	Left Top, Right Top, Center, Left Bottom, Right Bottom		
	VGA OUT (Standby)	Off/On		
	Test Pattern	None/ Grid/ "H/V Mark"		
	Reset to Default	Yes/No		
Volume	Speaker	On/Off		
	Audio Out	On/Off		
	Microphone	On/Off		
	Mute	On/Off		
	Microphone Volume			
	Volume			



# User Controls

Options	Auto Source	On/Off			
	Input	VGA/ HDMI-1/ HDMI-2/ HDBaseT			
	Auto Power Off (Min)				
	SSI Setting	SSI Hours Used (Normal)			
		SSI Hours Used (ECO)			
		SSI Power Mode	Normal/ ECO		
	High Altitude	On/ Off			
	Optional Filter Settings	Optional Filter Installed	Yes/ No		
		Filter Usage Hours (Read only)			
		Filter Reminder			
		Cleaning Up Reminder	Yes/ No		
	Information	Model Name			
		SNID			
		Main Source			
		Sub Source			Displayed if PIP/PBP enabled
		Main Source Resolution			
		Sub Source Resolution			Displayed if PIP/PBP enabled
		SW Version (DDP/MCU/ LAN)			
		Aspect Ratio			
		SSI Hours (Normal/Eco)			
		IP Address			
		Network Status			
	PIP-PBP Module	Version			Displayed MST9813 Version
USB Upgrade		Yes/ No			
Projector ID					

# User Controls

3D	3D	On/ Off			
	3D Invert	On/ Off			
		Frame Packing			
		Side-by-Side (Half)			
		Top and Bottom			
		Frame Sequential			
	1080p @ 24	96Hz/144Hz			
LAN	Status	Connected/ Disconnected (Read only)			
	DHCP Client	On/ Off			
	IP Address			Read only if DHCP on	
	Subnet Mask			Read only if DHCP on	
	Gateway			Read only if DHCP on	
	DNS			Read only if DHCP on	
	Store	On/ Off			
	MAC Address			Read only	
	Group Name			Read only	
	Projector Name				
	Location			Read only	
	Contact			Read only	
Interactive	Interactive Settings	On/ Off			

## On-screen Display Menus

The Projector has multilingual On-screen Display menus that allow you to make image adjustments and change a variety of settings.

### How to operate

1. To open the OSD menu, press “Menu” on the Remote Control or Projector Keypad.
2. When OSD is displayed, use the ▲▼ keys to select any item in the main menu. While making a selection on a particular page, press the ► or “Enter” key to enter sub menu.
3. Use the ▲▼ keys to select the desired item and adjust the settings using the ◀▶ key.
4. Select the next item to be adjusted in the sub menu and adjust as described above.
5. Press “Enter” to confirm, and the screen will return to the main menu.
6. To exit, press “Menu” again. The OSD menu will close and the projector will automatically save the new settings.

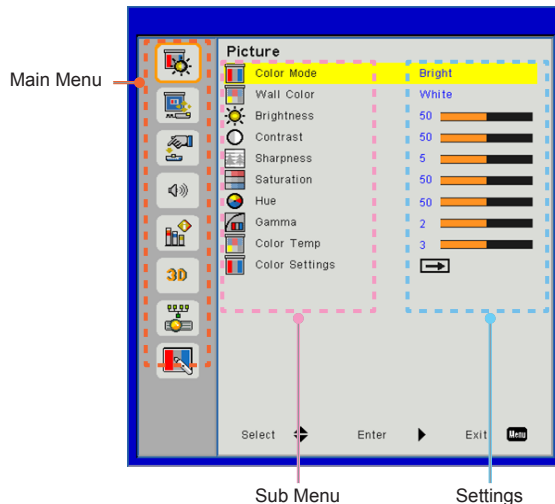

# User Controls

## Picture



### Color Mode

There are many factory presets optimized for various types of images. Use the ◀ or ▶ button to select the item.

- ▶ Bright: For brightness optimization.
- ▶ Presentation: For meeting presentation.
- ▶ Movie: For playing video content.
- ▶ Game: For game content.
- ▶ Blending: For blending application.
- ▶ User: Memorize user's settings.

### Wall Color

Use this function to obtain an optimized screen image according to the wall color. You can select from "White", "Light Yellow", "Light Blue", "Pink", and "Dark Green".

### Brightness

Adjust the brightness of the image.

- ▶ Press the ◀ button to darken image.
- ▶ Press the ▶ button to brighten image.

## Contrast

The Contrast controls the difference between the lightest and darkest parts of the picture. Adjusting the contrast changes the amount of black and white in the image.

- ▶ Press the ◀ button to decrease the contrast.
- ▶ Press the ▶ button to increase the contrast.

## Sharpness

Adjust the sharpness of the image.

- ▶ Press the ◀ button to decrease the sharpness.
- ▶ Press the ▶ button to increase the sharpness.

## Saturation

Adjust a video image from black and white to fully saturated color.

- ▶ Press the ◀ button to decrease the amount of saturation in the image.
- ▶ Press the ▶ button to increase the amount of saturation in the image.

## Hue

Adjust the color balance of red and green.

- ▶ Press the ◀ button to increase the amount of green in the image.
- ▶ Press the ▶ button to increase the amount of red in the image.

## Gamma

This allows you to adjust the gamma value to obtain the better image contrast for the input.

## Color Temp

This allows you to adjust the color temperature. At higher temperature, the screen looks colder; at lower temperature, the screen looks warmer.

## Color Setting

Use these settings for advanced adjustment of the individual Red, Green, Blue, Cyan, Magenta and Yellow and White Colors.



- ❖ “Sharpness”, “Saturation” and “Hue” functions are only supported under video mode.

# User Controls

## Screen

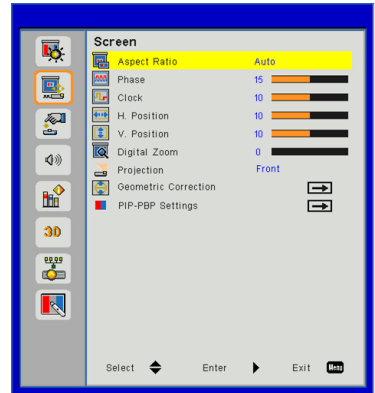

### Aspect Ratio

- ▶ Auto: Keep the image with original width-height ratio and maximize the image to fit native horizontal or vertical pixels.
- ▶ 4:3: The image will be scaled to fit the screen and displayed using a 4:3 ratio.
- ▶ 16:9: The image will be scaled to fit the width of the screen and the height adjusted to display the image using a 16:9 ratio.
- ▶ 16:10: The image will be scaled to fit the width of the screen and the height adjusted to display the image using a 16:10 ratio.



- ❖ “H. Position” and “V. Position” ranges will depend on input source.

### Phase

Synchronize the signal timing of the display with the graphic card. If the image appears to be unstable or flickers, use this function to correct it.

### Clock

Adjust to achieve an optimal image when there is a vertical flicker in the image.

### H. Position

- ▶ Press the ◀ button to move the image left.
- ▶ Press the ▶ button to move the image right.

### V. Position

- ▶ Press the ◀ button to move the image down.
- ▶ Press the ▶ button to move the image up.

# User Controls

## Digital Zoom

- ▶ Press the ◀ button to reduce the size of an image.
- ▶ Press the ▶ button to magnify an image on the projection screen.

## Projection

- ▶ Front: The image is projected straight on the screen.
- ▶ Front Ceiling: This is the default selection. When selected, the image will turn upside down.
- ▶ Rear: When selected, the image will appear reversed.
- ▶ Rear Ceiling: When selected, the image will appear reversed in upside down position.

## Geometric Correction

- ▶ H Keystone  
Press the ◀ or ▶ button to adjust image distortion horizontal. If the image looks trapezoidal, this option can help make the image rectangular.
- ▶ V Keystone  
Press the ◀ or ▶ button to adjust image distortion vertically. If the image looks trapezoidal, this option can help make the image rectangular.
- ▶ Warp Control: Off/ Manual/ Auto
- ▶ Warp Sharpness: 0~9
- ▶ Warp Number: 2x2/ 3x3/ 5x5/ 9x9/ 17x17
- ▶ Warp Inner: Off/ On
- ▶ Blend Setting: Left/Right/Top/Bottom/Blend Gamma
- ▶ Grid Color  
Set grid color of warp and blend pattern.
- ▶ Reset  
Set H/V Keystone, warp and blend parameters to default values.

# User Controls

## PIP-PBP Settings

- ▶ Function: To enable/disable PIP/PBP function.
- ▶ Main Source: To set PIP/PBP main source.
- ▶ Sub Source: To set PIP/PBP sub source.
- ▶ H Position:
- ▶ V Position:
- ▶ Size: To set PIP sub source size.
- ▶ Swap: To swap PIP/PBP main/sub source.

### ❖ PIP / PBP Matrix:

Main Sub	HDMI 1	HDMI 2	HDBaseT	VGA
HDMI 1	√	√	√	√
HDMI 2	√	√	√	√
HDBaseT	√	√	√	√
VGA	√	√	√	√



## Setting

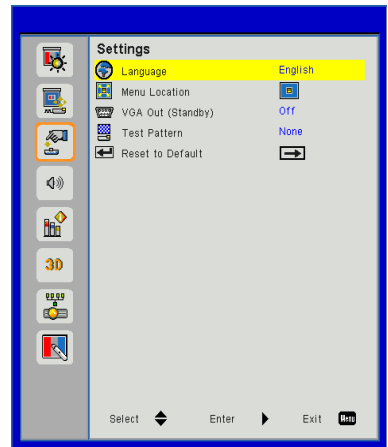

### Language

Choose the multilingual OSD menu. Press the ◀ or ▶ button into the sub menu and then use the ▲ or ▼ button to select your preferred language. Press ▶ on the remote control to finalize the selection.



### Menu Location

Choose the menu location on the display screen.

### VGA Output (Standby)

Choose "On" to enable VGA OUT connection.

# ***User Controls***

## Test Pattern

Display a test pattern.

## Reset

Choose “Yes” to return the parameters on all menus to the factory default settings.



# User Controls

## Options

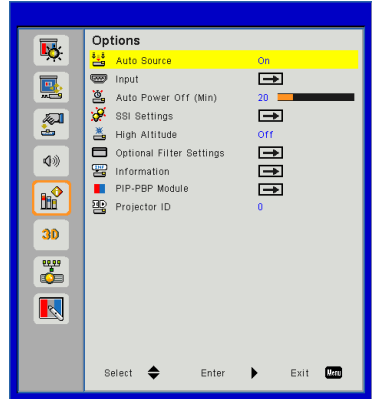

### Auto Source

- ▶ On: The projector will search for other signals if the current input signal is lost.
- ▶ Off: The projector will only search current input connection.

### Input

Press ▶ button to enable/disable input sources. The projector will not search for inputs that are not selected.

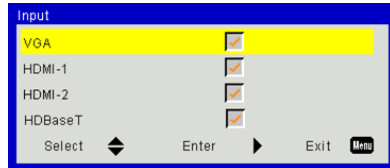

### Auto Power Off (Min)

Sets the countdown timer interval. The countdown timer will start, when there is no signal being sent to the projector. The projector will automatically power off when the countdown has finished (in minutes).

# User Controls

## SSI Settings

Refer to next page.

## High Altitude

- ▶ On: The built-in fans run at high speed. Select this option when using the projector at altitudes above 2500 feet/762 meters or higher.
- ▶ Off: The built-in fans automatically run at a variable speed according to the internal temperature.

## Optional Filter Settings

- ▶ Optional Filter Installed: Filter is installed or not.
- ▶ Filter Usage Hours: Hours of filter had been used.
- ▶ Filters Remind (Hour): Set the filter reminder time.
- ▶ Cleaning Up Remind: Select "Yes" to reset the dust filter hour counter after replacing or cleaning the dust filter.

## Information

Model name, SNID, signal source, resolution, software version, aspect ratio, IP address, network status and other information on projector are displayed on the screen.

## PIP-PBP Module

- ▶ Version: Show PIP-PBP module software version.
- ▶ HDMI EQ: Set PIP-PBP module HDMI port EQ value.
- ▶ Reset: Reset the PIP-PBP module.
- ▶ USB Upgrade: Upgrade the PIP-PBP module software.

## Projector ID

ID definition can be set up by menu (range 0-99), and allow user control an individual projector by using RS232 command.

# User Controls

## Options | Laser Settings

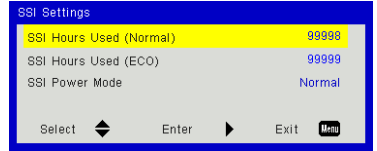

### SSI Hours Used (Normal)

Display the projection time of normal mode.

### SSI Hours Used (ECO)

Display the projection time of ECO mode.

### SSI Power Mode

- ▶ Normal: Normal mode.
- ▶ ECO: Use this function to dim the projector light source which will lower power consumption and extend the light source life.

# User Controls

## 3D

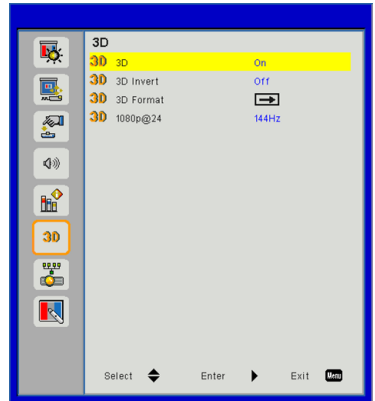

- ❖ “Frame Sequential” is supported the DLP Link 3D input signals from VGA / HDMI connector.
- ❖ “Frame Packing” / “Side-by-Side(Half)” / “Top and Bottom” are supported from HDMI 1.4a 3D input signals.

### 3D

- ▶ Auto: When a HDMI 1.4a 3D timing identification signal is detected, the 3D image is selected automatically.
- ▶ Choose “On” to enable 3D function.

### 3D Invert

If you see a discrete or overlapping image while wearing DLP 3D glasses, you may need to execute “Invert” to get best match of left/right image sequence to get the correct image.

### 3D Format

Use this feature to select the 3D format. Options are: “Frame Packing”, “Side-by-Side (Half)”, “Top and Bottom” and “Frame Sequential”.

### 1080p@24

Use this feature to select 96 or 144Hz refresh rate as using 3D glasses in the 1080p @ 24 frame packing.

# User Controls

## LAN



### Status

Display the network connection status.

### DHCP

Configure the DHCP settings.

- ▶ On: Choose “On” to let the projector to obtain an IP address automatically from your network.
- ▶ Off: Choose “Off” to assign IP, Subnet Mask, Gateway, and DNS configuration manually.

### IP Address

Display an IP address.

### Subnet Mask

Display the subnet mask number.

### Gateway

Display the default gateway of the network connected to the projector.

### DNS

Display the DNS number.

### Store

Save the modification of network settings.



# ***User Controls***

## MAC Address

Display the MAC address.

## Group Name

Display the group name.

## Projector Name

Display the projector name.

## Location

Display the projector location.

## Contact

Display the contact information.

# User Controls

## Interactive

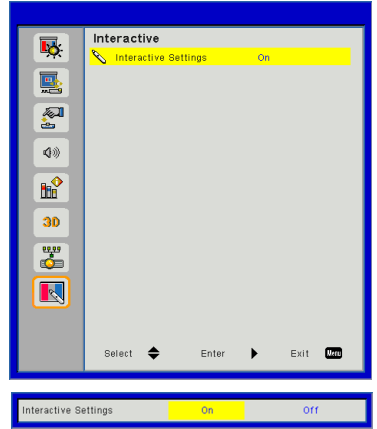

- ❖ Interaction function: Use the Mini USB cable to connect PC/laptop and projector. Connect before using the interactive function. After you complete the Interactive Settings in OSD, use the Mini USB cable to connect a NB/desktop to the projector.

### Interactive Settings

- ▶ Choose “On” to enable Interactive function for auto blending application.
- ▶ Choose “Off” to disable Interactive function. Auto blending application can not work in this mode.

# User Controls

## How to use web browser to control your projector

1. Turn on DHCP to allow a DHCP server to automatically assign an IP, or manually enter the required network information.

Status	Connect
DHCP	Off
IP Address	172.16.1.42
Subnet Mask	255.255.255.0
Gateway	172.16.1.254
DNS	172.16.1.1

2. Then choose apply and press **OK** button to complete the configuration process.

3. Open your web browser and type in IP Address from the OSD LAN screen then the web page will display as below:



4. Based on network web-page for the input-string in [tools] tab, the limitation for Input-Length is in the below list ("space" and the other punctuation key included):

Category	Item	Input-Length (characters)
Crestron Control	IP Address	15
	IP ID	2
	Port	5
Projector	Projector Name	10
	Location	9
	Assigned To	9
Network Configuration	DHCP (Enabled)	(N/A)
	IP Address	15
	Subnet Mask	15
	Default Gateway	15
	DNS Server	15
User Password	Enabled	(N/A)
	New Password	15
	Confirm	15
Admin Password	Enabled	(N/A)
	New Password	15
	Confirm	15



❖ When you used the projector IP address, you will can not link to your service server.

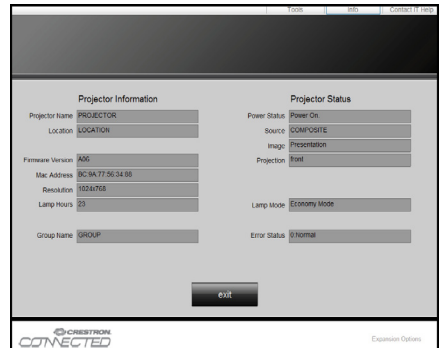

# User Controls

## 1. When making a direct connection from your computer to the projector

Step 1: Find an IP Address (192.168.0.100) from LAN function of projector.



Step 2: Select apply and press “Enter” button to submit function or press “menu” key to exit.

Step 3: To open Network Connections, click **Start**, click **Control Panel**, click **Network and Internet Connections**, and then click **Network Connections**. Click the connection you want to configure, and then, under **Network Tasks** , click **Change settings of this connection**.

Step 4: On the **General** tab, under **This connection uses the following items**, click **Internet Protocol (TCP/IP)**, and then click “Properties.”

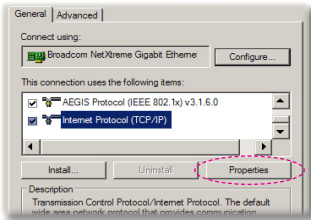

Step 5: Click **Use the following IP address**, and type in as below:

- 1) IP address: 192.168.0.101
- 2) Subnet mask: 255.255.255.0
- 3) Default gateway: 192.168.0.254

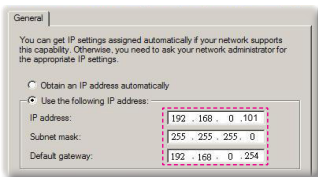

Step 6: To open Internet Options, click IE web browser, click Internet Options, click the **Connections** tab and click “LAN Settings...”

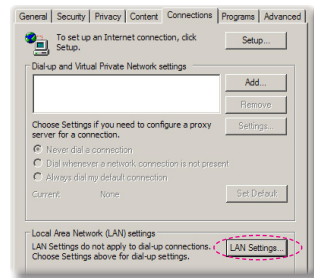

Step 7: The **Local Area Network (LAN) Setting** dialog box appears. In the **Proxy Server** area, uncheck **Use a proxy server for your LAN**, then click “OK” button twice.

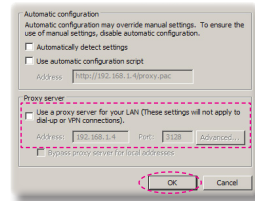

Step 8: Open your IE and type in the IP address of 192.168.0.100 in the URL then press “Enter” key.

# User Controls

## 2. Access to Web Management Page

Open IE browser and type in the IP address 192.168.0.100 in the URL then press “Enter” key and key in password to enter Web Management page



Admin

Crestron

User Name admin

Password

Login

\* Default Password: admin

Contents Copyright 2011 by Optoma, Inc.

## System Status

User can retrieve the System Status in this page



Logout

Admin > System Status

System Status	<b>Model Name</b> DAZHHNZUST
General Setup	<b>Projector Name</b> Optoma 1080p
Projector Control	<b>Version</b>
Network Setup	Firmware Version C12.01
Alert Setup	MCU Version C07
Crestron	GPU Version C10
Reset to Default	Network Version C07
Reboot System	<b>LAN Status</b>
	IP Address 192.168.0.100
	Subnet Mask 255.255.255.0
	Default Gateway 192.168.0.254
	MAC Address 00:50:41:87:3E:C6

Contents Copyright 2011 by Optoma, Inc.

# User Controls

## General Setup

User can configure general parameters in this page.



Logout

Admin > General Setup

System Status	Group Name	<input type="text" value="Projector"/>	Apply
General Setup	Projector Name	<input type="text" value="Optoma 1080p"/>	Apply
Projector Control	Location	<input type="text"/>	Apply
Network Setup	Contact	<input type="text"/>	Apply
Alert Setup	<b>Change Password for Webpage</b>		
Crestron	Enter Old password	<input type="password" value="....."/>	
Reset to Default	Enter New password	<input type="password" value="....."/>	
Reboot System	Confirm New password	<input type="password" value="....."/>	Apply

Contents Copyright 2011 by Optoma, Inc.

## Projector Control

User can configure the projector parameters and control the projector in this page.



Logout

Admin > Projector Control

System Status	Power On	Power Off	Color Mode	Presentation
General Setup	SSI Power mode	Normal	Brightness	49
Projector Control	Reset		Contrast	52
Network Setup	Auto Source	On	Sharpness	5
Alert Setup	Source	HDMI 2	Saturation	50
Crestron	Auto Power Off (Min.)	20	Hue	50
Reset to Default	High Altitude	Off	Gamma	2
Reboot System	Cleaning Reminder		Color Temperature	0
	Filters Remind(Hour)	500	Aspect Ratio	Auto
	3D	Auto	Phase	30
	3D Sync. Invert	Off	Clock	50
	3D Format	Frame Packing	H Position	0

Contents Copyright 2011 by Optoma, Inc.

# User Controls

## Network Setup

User can configure LAN parameters in this page.



Logout

**Admin > Network Setup**

System Status	DHCP Client	<input type="radio"/> On <input checked="" type="radio"/> Off				
General Setup	IP Address	192	168	0	100	
Projector Control	Subnet Mask	255	255	255	0	
Network Setup	Default Gateway	192	168	0	254	
Alert Setup	DNS Server	192	168	0	1	Apply
Crestron						
Reset to Default						
Reboot System						

Contents Copyright 2011 by Optoma, Inc.

## Alert Setup

User can assign the email address and categorize alert notice.



Logout

**Admin > Alert Setup**

System Status	Alert Type	<input type="checkbox"/> System Overtemp <input type="checkbox"/> Fan1 Error <input type="checkbox"/> Fan2 Error <input type="checkbox"/> Fan3 Error			
General Setup		<input type="checkbox"/> DMD Fan Error <input type="checkbox"/> PW Fan Error <input type="checkbox"/> Color Wheel Fail <input type="checkbox"/> Laser Error			
Projector Control	<input type="checkbox"/> Alert Mail Notification				
Network Setup	<b>SMTP Setting</b>				
Alert Setup	SMTP Server				
Crestron	From				
Reset to Default	User Name				
Reboot System	Password				
	<b>Email Setting</b>				
	Mail Subject	Projector Alert			
	Mail Content				

Contents Copyright 2011 by Optoma, Inc.

# User Controls

## Reset to Default

User can use this function to set the LAN module parameters to default values.

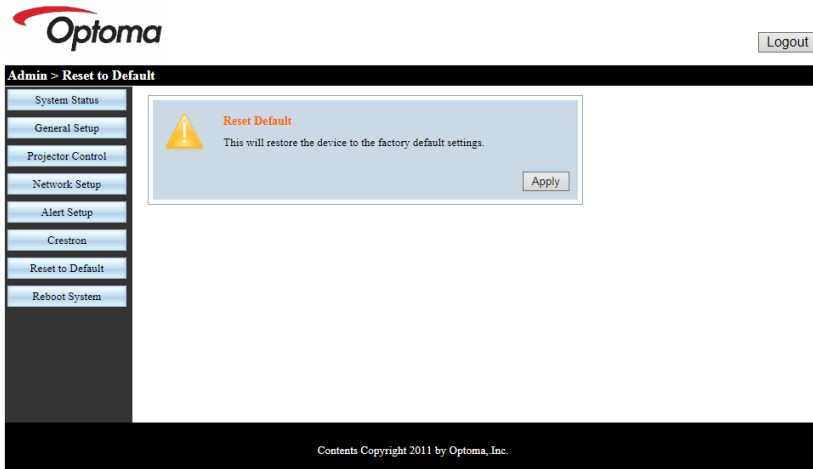

The screenshot shows the Optoma web interface. At the top left is the Optoma logo. At the top right is a 'Logout' button. Below the logo is a navigation menu with the following items: System Status, General Setup, Projector Control, Network Setup, Alert Setup, Crestron, Reset to Default, and Reboot System. The 'Reset to Default' option is selected. The main content area displays a warning icon (a yellow triangle with an exclamation mark) and the text 'Reset Default' in red. Below this, it says 'This will restore the device to the factory default settings.' and there is an 'Apply' button. At the bottom of the page, it says 'Contents Copyright 2011 by Optoma, Inc.'

## Reboot System

User can use this function to re-boot the LAN module.

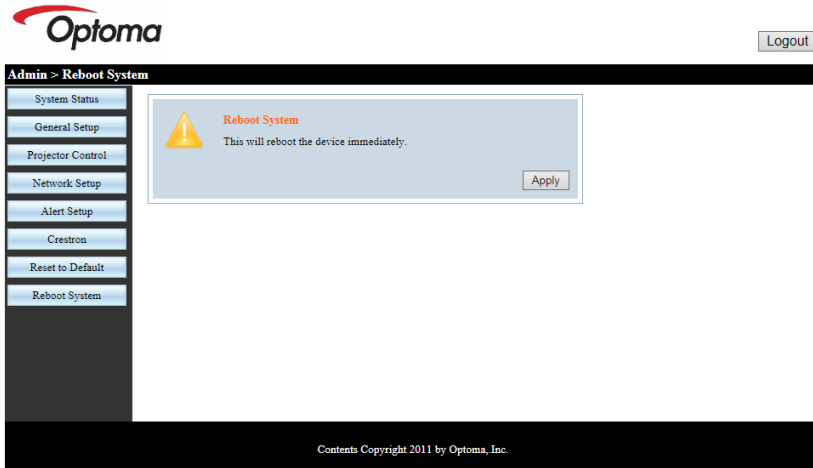

The screenshot shows the Optoma web interface. At the top left is the Optoma logo. At the top right is a 'Logout' button. Below the logo is a navigation menu with the following items: System Status, General Setup, Projector Control, Network Setup, Alert Setup, Crestron, Reset to Default, and Reboot System. The 'Reboot System' option is selected. The main content area displays a warning icon (a yellow triangle with an exclamation mark) and the text 'Reboot System' in red. Below this, it says 'This will reboot the device immediately.' and there is an 'Apply' button. At the bottom of the page, it says 'Contents Copyright 2011 by Optoma, Inc.'



# User Controls

## Crestron

User can control projector via Crestron flash UI.



# User Controls

## Crestron RoomView Control Tool

Crestron RoomView™ provides a central monitoring station for 250+ control systems on a single Ethernet network (more are possible, the number depends on the combination of IP ID and IP address). Crestron RoomView monitors each projector, including projector's online status, system power, light source life, network setting and hardware faults, plus any custom attribute as defined by the Administrator. The Administrator can add, delete, or edit room information, contact information and events, which are logged automatically by the software for all users. (Operation UI as following image)

### 1. Main Screen

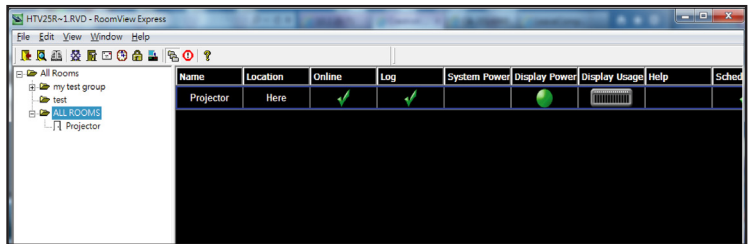

### 2. Edit Room



- ❖ Crestron RoomView's function is set according to the products' models and specifications.

General | Groups | Attributes | Assets | Contacts | Events |

Room Information

Name: crestron room Phone: [ ]

Location: [ ] e-Control Link: [ ] Browse...

IP Address: 192.168.0.101 Video Link: [ ]

IPID/IP Port: 03 | 41794

DHCP Enabled

External Gateway: 0.0.0.0

SSL

Username: [ ]

Password: [ ]

Comment: [ ]

Save Room Save As Help

OK Cancel Apply

# User Controls

## 3. Edit Attribute

The screenshot shows the 'Edit Attribute: Display Power' dialog box. It has tabs for 'General', 'Alert', 'Groups', and 'Contacts'. The 'General' tab is active. Under 'Attribute Properties', there is a text field for 'Signal Name' containing 'Display Power', a 'Device' dropdown menu set to 'None', and a 'Signal Type' dropdown menu set to 'Digital'. To the right, there is a 'Graphic' section with two buttons: 'Off' (with a red circle) and 'On' (with a green circle). Below this, there are 'Join Number' and 'Default Max. Value' fields. The 'Options' section contains four checkboxes: 'Apply attribute to all rooms' (checked), 'Apply attribute to all contacts' (unchecked), 'Record attribute changes to log' (checked), and 'Display on main view' (checked). There is also a 'Show on context menu' checkbox with an 'Advanced...' button next to it. At the bottom are 'OK', 'Cancel', and 'Apply' buttons.

## 4. Edit Event

The screenshot shows the 'Edit Event: Display Off Warning' dialog box. It has tabs for 'General' and 'Rooms'. The 'General' tab is active. Under 'Event Properties', there is a text field for 'Name' containing 'Display Off Warning', a 'Type' dropdown menu set to 'Digital', and a 'Join' dropdown menu set to '0'. To the right, there are two checkboxes: 'Enable this event' (unchecked) and 'Repeat event' (unchecked). The 'Schedule' section contains 'Start Date' (2010/ 9/ 2), 'End Date' (2010/ 9/ 2), and 'Time' (0:00:00) fields. Below these are checkboxes for 'Weekdays' (checked), 'Monday' (checked), 'Tuesday' (checked), 'Wednesday' (checked), 'Thursday' (checked), 'Friday' (checked), 'Weekends' (unchecked), 'Saturday' (unchecked), and 'Sunday' (unchecked). At the bottom are 'OK', 'Cancel', and 'Apply' buttons.

***For further information, please visit:***

***<http://www.crestron.com> & [www.crestron.com/getroomview](http://www.crestron.com/getroomview).***

# Appendices

## Compatibility Modes

		A. VGA Analog			
		(1) PC Signal			
Modes	Resolution	V.Frequency [Hz]	H.Frequency [KHz]	Pixel CLK [MHz]	EDID Description
VGA	640x480	60	31.5	25.2	Established Timings 1
	640x480	67	35.0	26.8	Established Timings 1
	640x480	72	37.9	31.5	Established Timings 1
	640x480	75	37.5	31.5	Established Timings 1
	640x480	85	43.3	36.0	
IBM	720x400	70	31.5	28.3	Established Timings 1
SVGA	800x600	56	35.1	36.0	Established Timings 1
	800x600	60	37.9	40.0	Established Timings 1
	800x600	72	48.1	50.0	Established Timings 2
	800x600	75	46.9	49.5	Established Timings 2
	800x600	85	53.7	56.3	
Apple, Mac II	832x624	75	49.1	57.3	Established Timings 2
XGA	1024x768	60	48.4	65.0	WXGA: Established Timings 2 XGA: Established Timings 2 and (Native)Detailed Timing / Descriptor Block 1
	1024x768	70	56.5	75.0	Established Timings 2
	1024x768	75	60.0	78.8	Established Timings 2
	1024x768	85	68.7	94.5	
	1024x768	120	99.0	137.8	Standard Timing Identification
Apple, Mac II	1152x870	75	68.7	100.0	Manufacturer's Reserved Timing
SXGA	1280x1024	60	64.0	108.0	
	1280x1024	72	77.0	133.0	
	1280x1024	75	80.0	135.0	Established Timings 2
QuadVGA	1280x960	60	60.0	101.3	Standard Timing Identification
	1280x960	75	75.2	130.0	
SXGA+	1400x1050	60	65.3	121.8	
UXGA	1600x1200	60	75.0	161.0	Standard Timing Identification
Full HD	1920x1080	60	67.5	148.5	
WUXGA	1920x1200	60	74	154	Reduced Blanking
		(2) Extended Wide timing			
WXGA	1280x720	60	44.8	74.2	Standard Timing Identification

# Appendices

	1280x800	60	49.6	83.5	WXGA: (Native)Detailed Timing / Descriptor Block 1 XGA: Standard Timing Identification
	1366x768	60	47.7	84.8	
	1440x900	60	59.9	106.5	Standard Timing Identification
WSXGA+	1680x1050	60	65.3	146.3	WXGA: Standard Timing Identification XGA: N/A
	1920x720	60	44.35	92.25	
<b>(3) Component Signal</b>					
480i	720x480 (1440x480)	59.94(29.97)	15.7	13.5	
576i	720x576 (1440x576)	50(25)	15.6	13.5	
480p	720x480	59.94	31.5	27.0	
576p	720x576	50	31.3	27.0	
720p	1280x720	60	45.0	74.25	
720p	1280x720	50	37.5	74.25	
1080i	1920x1080	60(30)	33.8	74.25	
1080i	1920x1080	50(25)	28.1	74.25	
1080p	1920x1080	23.98/24	27.0	74.25	
1080p	1920x1080	60	67.5	148.5	
1080p	1920x1080	50	56.3	148.5	
<b>B. HDMI Digital</b>					
<b>(1) PC Signal</b>					
Modes	Resolution	V.Frequency [Hz]	H.Frequency [KHz]	Pixel CLK [MHz]	EDID Description
VGA	640x480	60	31.5	25.2	Established Timings 1
	640x480	67	35.0	26.8	Established Timings 1
	640x480	72	37.9	31.5	Established Timings 1
	640x480	75	37.5	31.5	Established Timings 1
	640x480	85	43.3	36.0	
IBM	720x400	70	31.5	28.3	Established Timings 1
SVGA	800x600	56	35.1	36.0	Established Timings 1
	800x600	60	37.9	40.0	Established Timings 1
	800x600	72	48.1	50.0	Established Timings 2
	800x600	75	46.9	49.5	Established Timings 2
	800x600	85	53.7	56.3	
Apple, Mac II	832x624	75	49.1	57.3	Established Timings 2

# Appendices

XGA	1024x768	60	48.4	65.0	WXGA: Established Timings 2 XGA: Established Timings 2 and (Native)Detailed Timing / Descriptor Block 1
	1024x768	70	56.5	75.0	Established Timings 2
	1024x768	75	60.0	78.8	Established Timings 2
	1024x768	85	68.7	94.5	
	1024x768	120	99.0	137.8	Standard Timing Identification
Apple, Mac II	1152x870	75	68.7	100.0	Manufacturer's Reserved Timing
SXGA	1280x1024	60	64.0	108.0	
	1280x1024	72	77.0	133.0	
	1280x1024	75	80.0	135.0	Established Timings 2
QuadVGA	1280x960	60	60.0	101.3	Standard Timing Identification
	1280x960	75	75.2	130.0	
SXGA+	1400x1050	60	65.3	121.8	
UXGA	1600x1200	60	75.0	161.0	Standard Timing Identification
Full HD	1920x1080	60	67.5	148.5	
WUXGA	1920x1200	60	74	154	Reduced Blanking
<b>(2) Extended Wide timing</b>					
WXGA	1280x720	60	44.8	74.2	Standard Timing Identification
	1280x800	60	49.6	83.5	WXGA: (Native)Detailed Timing / Descriptor Block 1 XGA: Standard Timing Identification
	1366x768	60	47.7	84.8	
	1440x900	60	59.9	106.5	Standard Timing Identification
WSXGA+	1680x1050	60	65.3	146.3	WXGA: Standard Timing Identification XGA: N/A
	1920x720	60	44.35	92.25	
<b>(3) HDMI - Video Signal</b>					
640x480p	640x480	59.94/60	31.5	25.2	Short Video Descriptor of CEA EDID Timing
480i	720x480 (1440x480)	59.94(29.97)	15.7	13.5	Short Video Descriptor of CEA EDID Timing
576i	720x576 (1440x576)	50(25)	15.6	13.5	Short Video Descriptor of CEA EDID Timing
480p	720x480	59.94	31.5	27.0	Short Video Descriptor of CEA EDID Timing
576p	720x576	50	31.3	27.0	Short Video Descriptor of CEA EDID Timing
720p	1280x720	60	45.0	74.25	(Native)Short Video Descriptor of CEA EDID Timing
720p	1280x720	50	37.5	74.25	(Native)Short Video Descriptor of CEA EDID Timing

# Appendices

1080i	1920x1080	60(30)	33.8	74.25	Short Video Descriptor of CEA EDID Timing
1080i	1920x1080	50(25)	28.1	74.25	Short Video Descriptor of CEA EDID Timing
1080p	1920x1080	23.98/24	27.0	74.25	Short Video Descriptor of CEA EDID Timing
1080p	1920x1080	60	67.5	148.5	Short Video Descriptor of CEA EDID Timing
1080p	1920x1080	50	56.3	148.5	Short Video Descriptor of CEA EDID Timing
<b>(4) HDMI 1.4a mandatory 3D timing- Video Signal</b>					
Frame Packing	720p	50	75	148.5	Short Video Descriptor of CEA EDID Timing
	720p	59.94/60	90	148.5	Short Video Descriptor of CEA EDID Timing
	1080p	23.98/24	54	148.5	Short Video Descriptor of CEA EDID Timing
Top-and-Bottom	720p	50	37.5	74.25	Short Video Descriptor of CEA EDID Timing
	720p	59.94/60	45.0	74.25	Short Video Descriptor of CEA EDID Timing
	1080p	23.98/24	27.0	74.25	Short Video Descriptor of CEA EDID Timing
<b>(5) Input signal frequency range</b> Analog: fh=15kHz ~ 100kHz, fv=24Hz ~ 120Hz, Max. pixel rate: 162.5MHz Digital (HDMI): fh=15kHz ~ 100kHz, fv=24Hz ~ 120Hz, Max. pixel rate: 225MHz					

# Appendices

## Ceiling Mount Installation

1. To prevent damage to your projector, please use the Optoma ceiling mount.
2. If you wish to use a third party ceiling mount kit, please ensure the screws used to attach a mount to the projector meet the following specifications:
  - ▶ Screw type: M4\*4
  - ▶ Minimum screw length: 10mm



- ❖ Please note that damage resulting from incorrect installation will void the warranty.



### ⚠ Warning:

1. If you buy a ceiling mount from another company, please be sure to use the correct screw size. Screw size will vary depending on the thickness of the mounting plate.
2. Be sure to keep at least 10 cm gap between the ceiling and the bottom of the projector.
3. Avoid installing the projector near a heat source.

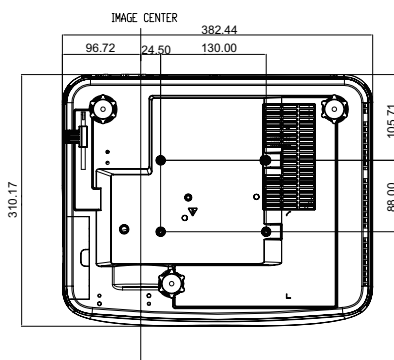
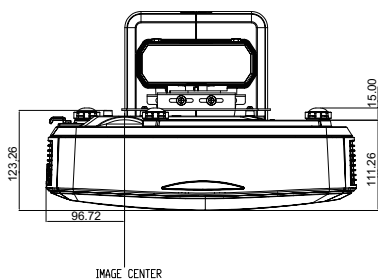



## Manual Warp Control Instruction

### Step 1: Device Set Up

Reference the installation measurement chart for Ultra Short Throw (TR.25) Projector to set up the projectors. (Refer to the “Installation” section.)

### Step 2: Warping IR on/off key

The IR receiving function of projector can be closed temporarily by hot key when adjusting warp and blend (pattern is on) to avoid the IR interference with each projector.

Setting:

- (1) Turned on the hot key via the key combination: Press “Off” first, and then press “On”
- (2) There are four options for hot keys: Correction, PIP/PBP, F1, F2
- (3) Press the hotkey to turn on the function. Press the hotkey again to turn off the function.
- (4) Turn on the function “IR On/Off All Range” can start hotkey at any time.  
When turn off the function, user can start hot key in blending setting and warp pattern only.



❖ When hotkey is on, the default function of Correction, PIP/PBP, F1, F2 are inactive temporarily.

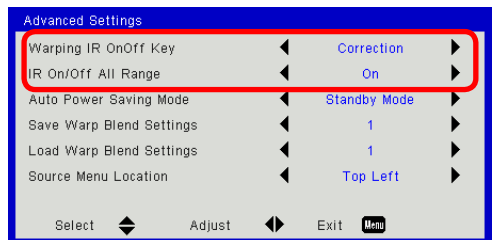
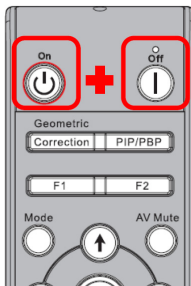

# Appendices

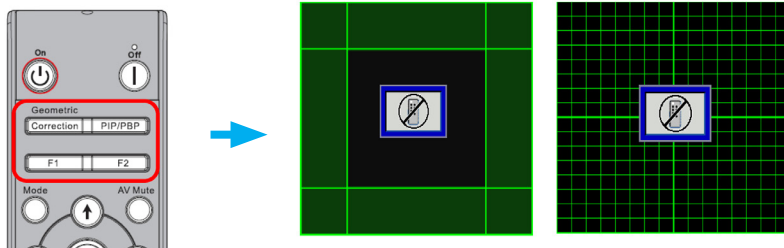

## Step 3: Select Manual for Warp Control

### 1. Function:

❖ The functions, "Warp Sharpness", "Warp Number", "Warp Inner", "Blend Setting", "Grid Color", are for manual warp control mode only.

There are three options for Warp Control:

- (1) Off: Close warp control function
- (2) Manual: Warp control by manual
- (3) Auto: Warp control by software automatically

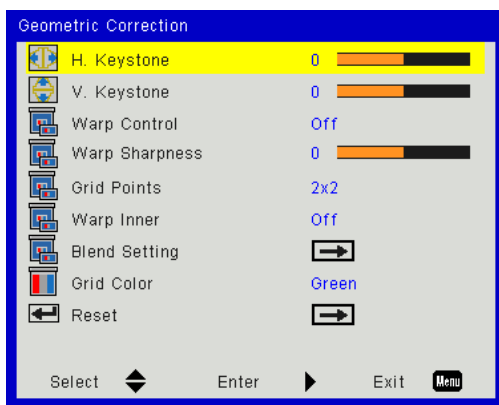
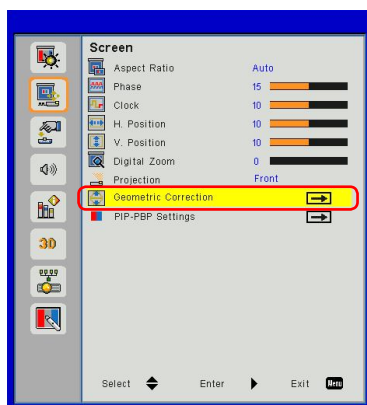

## Step 4: Grid Color

Change the grid color can help user to distinguish between grid lines with different projectors when doing warping adjustment.

### 1. Function:

There are four options for grid color : Green / Purple / Red / Cyan

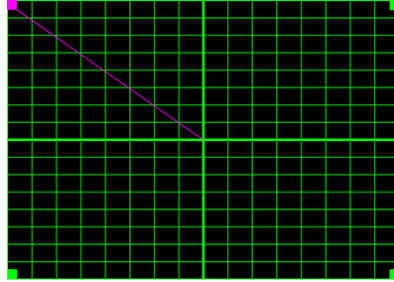

❖ **Blend Pattern** The blend pattern is opened automatically when blend setting finished.

## Step 5: Blend Setting-Set Overlap Size

### 1. Function:

There are four options for Blend Setting. The options and effective range of overlap size as below,

- (1) Left : 0(0%) / 192(10%) ~ 960(50%)
- (2) Right : 0(0%) / 192(10%) ~ 960(50%)
- (3) Top : 0(0%) / 108(10%) ~ 540(50%)
- (4) Bottom : 0(0%) / 108(10%) ~ 540(50%)

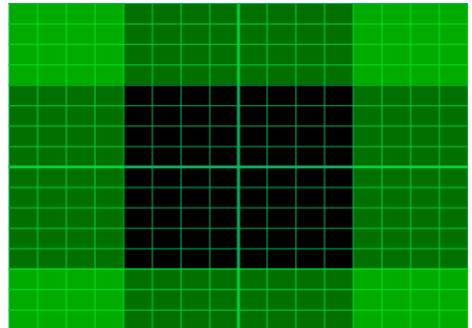
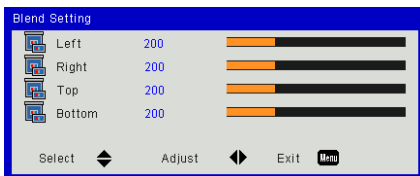

# Appendices

## 2. Setting:

- (1) Set up projectors and then setting the overlap size according to the actual projections
  - A. Be sure the overlap size for setting is smaller than the overlap size of actual projection.
  - B. Take advantage of warping IR on/off hot key to avoid IR interference.
  - C. Turn on the Blend Setting menu for all the projectors helps determine the effective overlap range.

Take projector setting layout 1x2 for an example and follow the steps below,

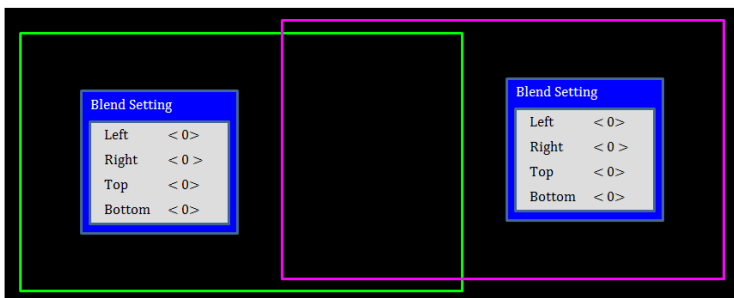

- (2) Adjust the overlap size of right boundary of left projector first.
  - A. The left side of overlap area will shift along with the values of blending setting.  
Overlap area is showed by a square with light color.
  - B. Adjust overlap size until the left side of overlap area of left projector is not exceed the left boundary of right projector.

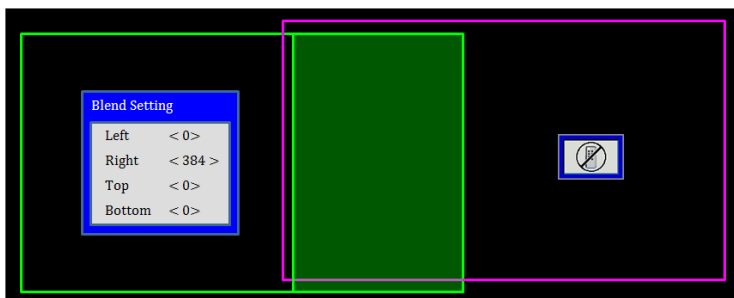

# Appendices

- (3) Adjust the overlap size of left boundary of right projector.
  - A. The right side of overlap area will shift along with the values of blending setting.  
Overlap area is showed by a square with light color.
  - B. Adjust the value of blending setting the same as the overlap size of the right boundary of left projector.
  - C. Mare sure the right side of overlap area is not exceed the right boundary of left projector.
  - D. If not, reduce the value of blend setting until the result match the condition of step C.
  - E. If the value of blending setting of right projector is less than left projector, adjust the value of left projector the same as right projector.

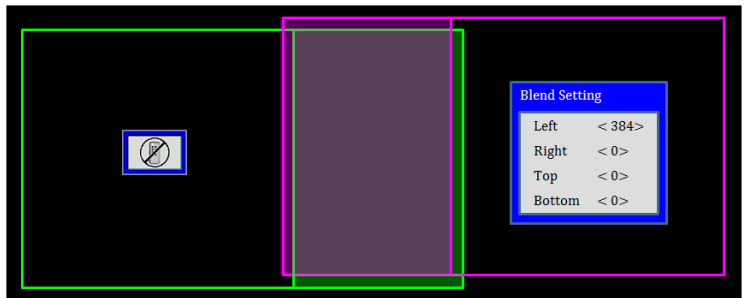

# Appendices

## Step 6: Warping

Use warp number and warp inner to finish the warping.

### 1. Function – Warp number

- (1) There are four options for Warp Number: 2x2, 3x3, 5x5, 9x9, 17x17. The warp pattern is opened automatically after selecting warp number.

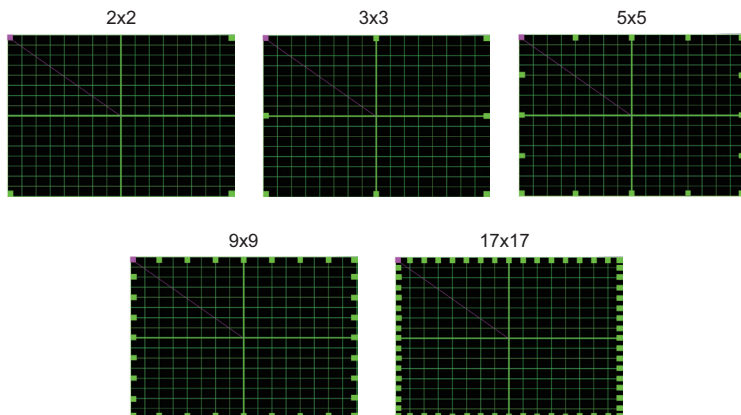

### (2) Flow chart:

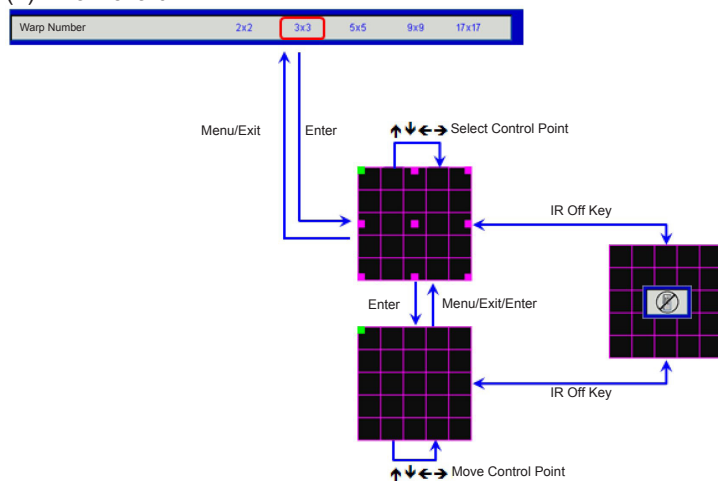

## 2. Function - Warp inner

There are two options for Warp Inner:

- (1) Off: Turn off inner control
- (2) On: Turn on inner control



- ❖ The warp pattern is opened automatically after selecting "on" for inner control.
- ❖ The warp inner doesn't work in warp number 2x2.

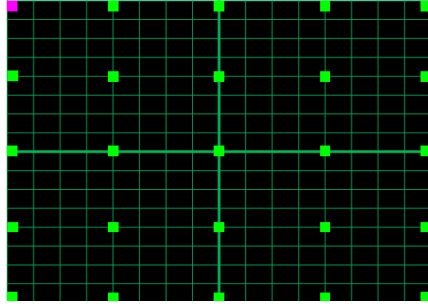

## 3. Setting:

Overlap area is divided into four parts equally in warping pattern. Warp adjustment to align the grid lines of overlap with two projectors to finish manual blending.

Follow the steps below,

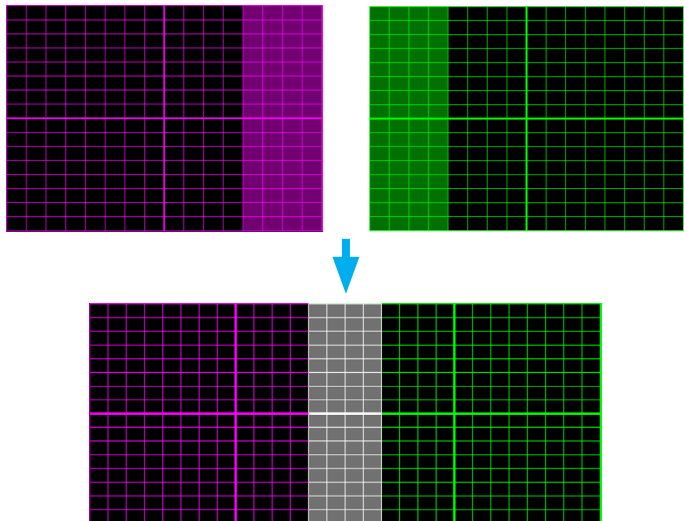

# Appendices

- (1) Select warp number 2x2 and align boundary of projectors with the side of overlap areas.
- (2) According to the actual situation to select warp number 3x3, 5x5 or 9x9 to adjust the grid line.
- (3) Turn on warp inner to adjust the inner grid.
- (4) All the grid lines are aligned. Press menu to exit grid pattern and then manual blending setting is finished.

## Step 7: Warp Sharpness

When the grid lines are warped from straight into curve, the grid lines will be distorted and become jagged.

To avoid the line jagged are too obvious, users can adjust the warp sharpness to blur or sharpen the edge of the images.

## Step 8: Reset

Restore the adjustment for warping /blending as default.





## Optoma global offices

For service or support, please contact your local office.



### USA

3178 Laurelview Ct.  
Fremont, CA 94538, USA  
[www.optomausa.com](http://www.optomausa.com)

 888-289-6786  
 510-897-8601  
 [services@optoma.com](mailto:services@optoma.com)



### Canada

3178 Laurelview Ct.  
Fremont, CA 94538, USA  
[www.optomausa.com](http://www.optomausa.com)

 888-289-6786  
 510-897-8601  
 [services@optoma.com](mailto:services@optoma.com)

### Latin America

3178 Laurelview Ct.  
Fremont, CA 94538, USA  
[www.optomausa.com](http://www.optomausa.com)  
[com](http://com)

 888-289-6786  
 510-897-8601  
 [services@optoma.com](mailto:services@optoma.com)



### Europe

42 Caxton Way, The Watford Business Park  
Watford, Hertfordshire,  
WD18 8QZ, UK  
[www.optoma.eu](http://www.optoma.eu)  
Service Tel : +44 (0)1923 691865

 +44 (0) 1923 691 800  
 +44 (0) 1923 691 888  
 [service@tsc-europe.com](mailto:service@tsc-europe.com)



### Benelux BV

Randstad 22-123  
1316 BW Almere  
The Netherlands  
[www.optoma.nl](http://www.optoma.nl)

 +31 (0) 36 820 0252  
 +31 (0) 36 548 9052



### France

Bâtiment E  
81-83 avenue Edouard Vaillant  
92100 Boulogne Billancourt,  
France

 +33 1 41 46 12 20  
 +33 1 41 46 94 35  
 [savoptoma@optoma.fr](mailto:savoptoma@optoma.fr)



### Spain

C/ José Hierro,36 Of. 1C  
28522 Rivas VaciaMadrid,  
Spain

 +34 91 499 06 06  
 +34 91 670 08 32



### Deutschland

Wiesenstrasse 21 W  
D40549 Düsseldorf,  
Germany

 +49 (0) 211 506 6670  
 +49 (0) 211 506 66799  
 [info@optoma.de](mailto:info@optoma.de)

### Scandinavia



Lerpeveien 25  
3040 Drammen  
Norway

 +47 32 98 89 90  
 +47 32 98 89 99  
 [info@optoma.no](mailto:info@optoma.no)

PO.BOX 9515  
3038 Drammen  
Norway

### Korea

WOOMI TECH.CO.,LTD.  
4F,Minu Bldg.33-14, Kangnam-Ku,  
seoul,135-815, KOREA

 +82+2+34430004  
 +82+2+34430005

### Japan



東京都足立区綾瀬3-25-18  
株式会社オーエス

 [info@os-worldwide.com](mailto:info@os-worldwide.com)  
[www.os-worldwide.com](http://www.os-worldwide.com)

コンタクトセンター:0120-380-495



### Taiwan

12F., No. 213,Sec. 3, Beixin Rd.,  
Xindian Dist., New Taipei City 231,  
Taiwan, R.O.C.  
[www.optoma.com.tw](http://www.optoma.com.tw)

 +886-2-8911-8600  
 +886-2-8911-6550  
 [services@optoma.com.tw](mailto:services@optoma.com.tw)  
[asia.optoma.com](http://asia.optoma.com)



### Hong Kong

Unit A, 27/F Dragon Centre,  
79 Wing Hong Street,  
Cheung Sha Wan,  
Kowloon, Hong Kong

 +852-2396-8968  
 +852-2370-1222  
[www.optoma.com.hk](http://www.optoma.com.hk)

### China

5F, No. 1205, Kaixuan Rd.,  
Changning District  
Shanghai, 200052, China

 +86-21-62947376  
 +86-21-62947375  
[www.optoma.com.cn](http://www.optoma.com.cn)

