

B419

5MP Zoom Bullet with D/N, Adaptive IR, Extreme WDR, SLLS, 10x Zoom Lens



- 5 Megapixel
- Day & Night with Superior Low Light Sensitivity and Adaptive IR LED
- 10x Zoom Lens with f4.7-47mm/F1.6-F3.0, DC iris, Auto focus
- Extreme WDR
- H.265 Compression
- Event trigger, response and notification

► Specifications

Device

Product Type	Zoom Bullet
Maximum Resolution	5MP
Application Environment	Outdoor
Image Sensor	Progressive Scan CMOS
Sensor Size	1/2.9 "
Effective Pixels	3092(H) X 2202(V) (6.82 MP)
Day / Night	Yes
Low Light Sensitivity	Superior
Minimum Illumination	Color: 0.1 lux at F1.6 (30 IRE, 2400 K); B/W: 0 lux at F1.6 (IR LED on)
Color to B/W Switch	ISP based switch, configurable
Mechanical IR Cut Filter	Yes
IR Sensitivity Range	700-1100nm
IR LED	Adaptive IR LED x 8 (850 nm)
IR Working Distance	60m
Electronic Shutter	1/5-1/64000 second (manual mode); 1/5-1/64000 second (auto mode)
Horizontal Resolution (TV Lines)	1750 TVL

S/N Ratio	56 dB
-----------	-------

Lens

Focal Length	Zoom, f4.7-47mm
Aperture	F1.6-F3.0
Zoom Ratio	10x optical
Zoom Application	Camera Installation, Auto Zoom by Event, Manual Operation
Iris	DC iris
Focus	Auto focus
Lens Mount	Board mount
Horizontal Viewing Angle	50.67° - 5.14°
Vertical Viewing Angle	39.23° - 3.86°

PTZ

Absolute Position	Yes
Pan, Tilt or Zoom protocol	Visca, Pelco-D, Pelco-P, ACTi URL command

Video

Compression	H.265, H.264 (Baseline/ Main/ High profile), MJPEG
Maximum Frame Rate vs. Resolution	30 fps at 2592 x 1944 30 fps at 2048 x 1536 30 fps at 1920 x 1080 30 fps at 1280 x 960 30 fps at 1280 x 720 30 fps at 800 x 600 30 fps at 640 x 480 30 fps at 320 x 240
Multi-Streaming	Simultaneous triple streams based on three configurations
Bit Rate	128Kbps - 12Mbps (per stream)
Bit Rate Mode	Constant, Variable
Wide Dynamic Range	Extreme WDR (120 dB)
Image Enhancement	White Balance, Brightness, Contrast, Saturation, Sharpness, Automatic gain control, Flickerless, Digital Image Stabilizer (DIS, EIS), Defogging
Digital Noise Reduction	2D + 3D DNR
Privacy Mask	32 configurable 3D privacy masks
Text Overlay	Yes
Built-in Analytics	Object Based Motion Detection, Tampering Detection, Shock Detection
Server-based Analytics	Object Line Counting, People Counting, Face Detection, Object Based Motion Detection, Tamper, Object Line Crossing Detection, Object Enter Area Detection, Missing Object Detection, Unattended Object Detection, Smoke Detection, Heat Map, Dwell Time, Direction Detection, Automatic License Plate Recognition, People Queue Detection, (Require PC-based or standalone IVS or ALPR Server. Contact ACTi support for recommendations on how to maximize analytical accuracy)
Image Orientation	Flip, Mirror, Rotation*

Audio

Audio Type	2-way, Built-in Microphone, Mic-in, Line-in, Line-out
Audio Compression	8 kHz, 16 bit encoding, Mono, PCM, G.711

Network

Network Protocol & Service	IPv4/v6, TCP, UDP, DHCP, PPPoE, HTTP, HTTPS, DNS, DDNS, NTP, RTP, RTSP, RTCP, SMTP, FTP, IGMP, ICMP, ARP, Bonjour, UPnP, QoS, SNMP, IEEE 802.1X
----------------------------	---

Ethernet Port	1 x RJ-45 pigtail connector
Security	IP address filtering, HTTPS encryption, Password protected user level, Anonymous login, IEEE 802.1X network access control

Event

Event Trigger	Video motion detection (10 included and excluded polygons regions), External device through digital input, Sound detection
Event Response	Notify control center, Go to Zoom preset point or preset tour, Change camera settings, Command other devices, E-mail notification with snapshots, Push notification to mobile device, Save video to local storage, Upload video to NVR server, Upload video or snapshot to FTP server, Activate external device through digital output

Integration

Unified Solution	Fully compatible with ACTi software
GPS Position	Manual setting
ONVIF Compliant	Yes, Profile S, Profile G, Profile T, Profile Q
GB28181 Compliant	Yes
Web Browser	IE 11
Auto Firmware Upgrade	Yes

Interface

Local Storage	MicroSDHC, MicroSDXC memory card slot (card not included)
Digital Input/Output	1/1

General

Power Source	DC 12V, High PoE
Power Consumption	25.5 W (PoE)
Weight	2134g (4.705lb)
Environmental Casing	Weatherproof (IP67), Vandal proof metal casing (IK10)
Bundled Accessories	Integrated bracket
Mount Type	Surface, Wall Mount, Ceiling Bracket, Pole Mount, Gang Box
Fan	Yes
Heater	Yes
Starting Temperature	-40°C ~ 60°C (-40°F ~ 140°F) within 30 minutes
Operating Temperature	-40°C ~ 60°C (-40°F ~ 140°F)
Operating Humidity	10% - 85% RH
Approvals	CE, FCC, IP67, IK10 (metal casing), NEMA 4X, UL (for optional PoE injector and power adapter)
Warranty	3 Year(s). For extended warranty offering, see http://www.acti.com/support/warranty

* To be available through future firmware upgrade

► Photo Indication



- 1 Ethernet Port
- 2 Audio Input / Output
- 3 DC 12V Power Input
- 4 Reset Button
- 5 Digital Input/Output
- 6 Memory Card Slot (inside the front cover)
- 7 Dehumidifier
- 8 Built-in Microphone



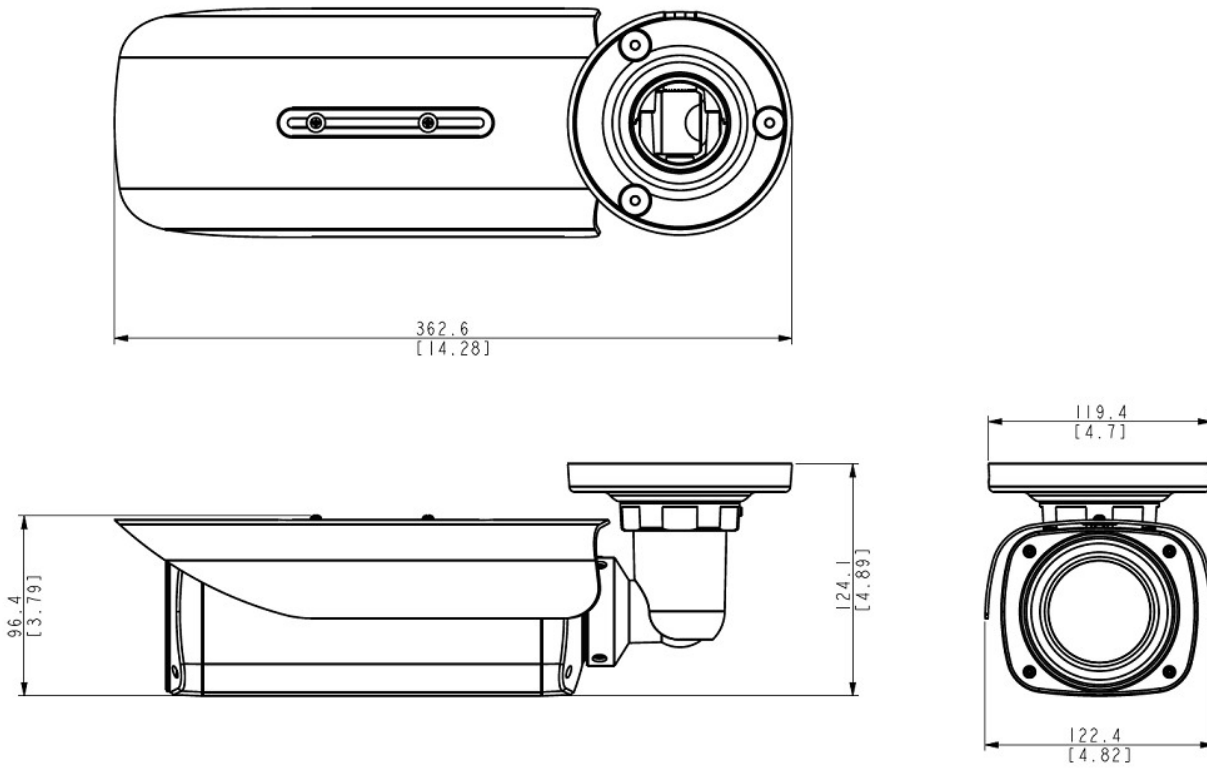

► Dimension Diagram



Unit: mm [inch]

▶ Related Products

Mounting Accessories - Camera Mount



PMAX-0508		Pole Mount (for PMAX-0203, PMAX-0204, PMAX-0205, PMAX-0206, PMAX-0704), supports 3" to 9" Poles
PMAX-0704		Junction Box (for A4x, B4x, B41x, E44, E45, E46, E48, E44A, E45A, E46A, E41x, I4x, PMAX-0203~PMAX-0205)
PMAX-0706		Junction Box (for A3x, A4x, E39, E41x, PMAX-0805)
R706-00006		Back Bracket with Pre-installed (For B41x, B43, I42, I48, E413, E415, E417)

Note: Some mounting accessories may need additional accessories for installation. Please check www.acti.com/mountingselector for more information.







Power Supply Accessories - Power Adapter

PPBX-0011		Power Adapter AC 100~240V, with universal connectors for all DC12V powered devices
-----------	---	--

Power Supply Accessories - PoE Injector

PPOE-0000		POE Injector , IEEE 802.3af compliant, AC 100~240V, for US & Japan
PPOE-0001		PoE Injector IEEE 802.3af compliant, AC 100~240V, with universal connectors

Network & Storage Peripherals - Data Switch

PPSW-0100		PLANET FGSD-910HP 8-Port 802.3at PoE Switch (PoE Budget 120W)
PPSW-0101		PLANET GS-4210-8P2T2S 8-Port Gigabit 802.3at Managed PoE Switch (PoE Budget 240W)
PPSW-0102		PLANET FGSD-1011HP 8-Port 802.3at PoE Switch (PoE Budget 120W)
PPSW-1101		PLANET GS-4210-24PL4C 24-Port Gigabit 802.3at Managed PoE Switch (PoE Budget 440W)
PPSW-2101		4-Port 802.3at PoE Switch (PoE Budget 62W)
PPSW-3100		PLANET FGSW-1816HPS 16-Port 802.3at PoE Switch (PoE Budget 220W)

Extenders - PoE Extender

PPEX-0100		Veracity OUTREACH Max Power over Ethernet (PoE) Extender
-----------	---	--

Extenders - PoE over Coaxial Extender Kit

PPOC-0100		Planet LRP-101C-KIT Power over Coax Adapter Kit
-----------	---	---

Illuminators - IR LED Illuminator

PLED-0200		SPINLUX (SL-A2IRXX10-24CL) IR Illuminator 10° Angle with 120 m approx. range
PLED-0201		SPINLUX (SL-A2IRXX25-24CL) IR Illuminator 25° Angle with 50 m approx. range
PLED-0202		SPINLUX (SL-A2IRXX35-24CL) IR Illuminator 35° Angle with 25 m approx. range
PLED-0204		SPINLUX (SL-A2IRXX25-48CL) IR Illuminator 25° Angle with 80 m approx. range
PLED-0205		SPINLUX (SL-A2IRXX35-48CL) IR Illuminator 35° Angle with 40 m approx. range



Other Accessories - Camera Part

R716-00001		Sunshield (for B4x, I4x)
------------	---	--------------------------

Product Demo - Camera Demo Kit

PCDK-0001		Camera Demo Kit Rack Box (350 x 550 x 140 mm) for all cameras except Mini Domes
-----------	---	---

Installation Support - Camera Installation Kit

PMON-1001-010		Camera Installation Kit for use with iOS Device with belt bag, battery and charger (US, AC 110~240V)
PMON-1001-011		Camera Installation Kit for use with iOS Device with belt bag, battery and charger (Europe, AC 110~240V)
PMON-2000		Camera Installation Kit