



Zoom Box Camera Series Hardware Manual

B21, B22, B23, B24, B25, B27, B210, B214,
B215, E210

I24, I25, I27, I28, I29

2017/07/04



ACTi
Connecting Vision

Table of Contents

Precautions 4

Safety Instructions	6
---------------------------	---

Introduction 7

The List of Models	7
Package Contents.....	9
Physical Description	10
Mounting Options	14

Before Installation..... 15

Connecting a Power Adapter (Optional)	15
Connecting the DI/DO and Audio Devices (Optional)	17
How to Connect DI/DO Devices	17
How to Connect Audio Devices	20
Connecting a Serial Device (Optional)	21

Indoor Installation Procedures 23

Step 1: Mount the Indoor Bracket	23
Step 2: Attach the Camera to the Bracket	24
Step 3: Connect the Cable(s)	26
Step 4: Access the Camera Live View	27

Other Adjustments and Accessories 28

How to Install / Remove the Memory Card	28
How to Insert the Memory Card	28
How to Remove the Memory Card.....	28
How to Reset the Camera	29

Accessing the Camera 30

Configure the IP Addresses	30
Access the Camera.....	34

Precautions

Read these instructions

You should read all the safety and operating instructions before using this product.

Heed all warnings

You must adhere to all the warnings on the product and in the instruction manual. Failure to follow the safety instructions given may directly endanger people, cause damage to the system or to other equipment.

Servicing

Do not attempt to service this product yourself as opening or removing covers may expose you to dangerous voltage or other hazards. Refer all servicing to qualified service personnel.

Trademarks

ACTi and ACTi logo are registered trademarks of ACTi Corporation. All other names and products used in this manual are registered trademarks of their respective companies.

Liability

Every reasonable care has been taken during the writing of this manual. Please inform your local office if you find any inaccuracies or omissions. ACTi will not be held responsible for any typographical or technical errors and reserves the right to make changes to the product and manuals without prior notice.

Federal Communications Commission Statement



This equipment has been tested and found to comply with the limits for a class B digital device, pursuant to Part 15 of the FCC Rules. These limits are designed to provide reasonable protection against harmful interference in a residential installation. This equipment generates, uses, and can radiate radio frequency energy and, if not installed and used in accordance with the instructions, may cause harmful interference to radio communications. However, there is no guarantee that interference will not occur in a particular installation. If this equipment does cause harmful interference to radio or television reception, which can be determined by turning the equipment off and on, the user is encouraged to try to correct the interference by one or more of the following measures:

- Reorient or relocate the receiving antenna.
- Increase the separation between the equipment and receiver.
- Connect the equipment into an outlet on a circuit different from that to which the receiver is connected.
- Consult the dealer or an experienced radio/TV technician for help.

Warning: Changes or modifications to the equipment that are not expressly approved by the responsible party for compliance could void the user's authority to operate the equipment.

European Community Compliance Statement



This product has been tested and found to comply with the limits for Class B Information Technology Equipment according to European Standard EN 55022 and EN 55024. In a domestic environment, this product may cause radio interference in which cause the user may be required to take adequate measures.

Safety Instructions

Cleaning

Disconnect this product from the power supply before cleaning.

Accessories and Repair Parts

Use only the accessories and repair parts recommended by the manufacturer.

Installation

Install this device in a dry place protected from weather.

Servicing

Do not attempt to service this product yourself. Refer all servicing to qualified service personnel.

Damage Requiring service

Disconnect this product from the power supply immediately and refer servicing to qualified service personnel under the following conditions.

- 1) When the power-supply cord or plug is damaged
- 2) If liquid has been spilled, or objects have fallen into the product.
- 3) If the inner parts of product have been directly exposed to rain or water.
- 4) If the product does not operate normally even by following the operating instructions in this manual. Adjust only those controls that are covered by the instruction manual, as improper adjustment of other controls may result in damage, and will often require extensive work by a qualified technician to restore the product to its normal operation.











Safety Check





Upon completion of any service or repairs to this product, ask the service technician to perform safety checks to determine if the product is in proper operating condition.

Introduction







The List of Models

This hardware manual contains the following models:

B21		5MP Zoom Box with D/N, Basic WDR, 12x Zoom lens
B22		5MP Zoom Box with D/N, Basic WDR, 10x Zoom lens
B23		3MP Zoom Box with D/N, Superior WDR, 10x Zoom lens
B24		1.3MP Zoom Box with D/N, Basic WDR, SLLS, 10x Zoom lens
B25		2MP Zoom Box with D/N, Basic WDR, SLLS, 10x Zoom lens
B27		3MP Zoom Box with D/N, Superior WDR, 12x Zoom lens
B210		10MP Zoom Box with D/N, Basic WDR, 10x Zoom lens
B214		2MP Video Analytics Zoom Box with D/N, Extreme WDR, SLLS, 20x Zoom lens
B215		2MP Video Analytics Zoom Box with D/N, Extreme WDR, SLLS, 30x Zoom lens
E210		10MP Zoom Box with D/N, Basic WDR, 4.3x Zoom lens
I24		1MP Zoom Box with D/N, Extreme WDR, ELLS, 30x Zoom lens

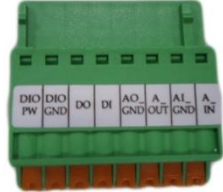
I25		2MP Zoom Box with D/N, Extreme WDR, ELLS, 30x Zoom lens
I27		4MP Zoom Box with D/N, Advanced WDR, SLLS, 30x Zoom lens
I28		2MP Video Analytics Zoom Box with D/N, Extreme WDR, SLLS, 33x Zoom lens
I29		2MP Video Analytics Zoom Box with D/N, Extreme WDR, ELLS, 36x Zoom lens

Package Contents

Camera	Terminal Block (for Power)	Terminal Block (for Audio and DI/DO)
		
Terminal Block (for Serial Port)	Quick Installation Guide	Warranty Card
		

NOTE: The pictures are for reference only. Actual items may slightly vary.

Physical Description

B2x / I2x

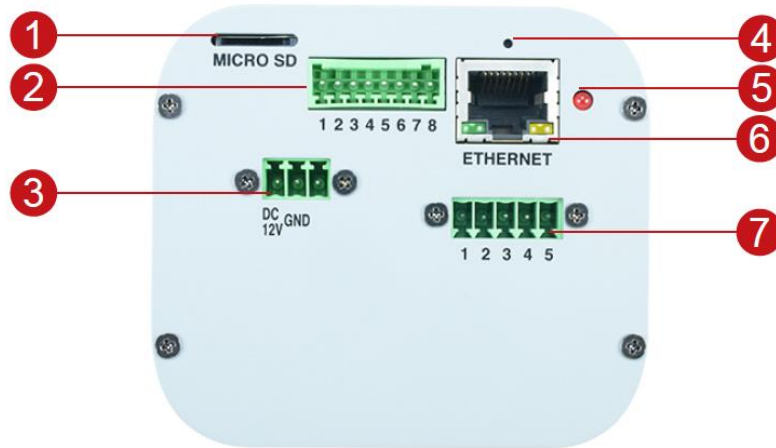

B23, B210, B214, B215, I28, I29

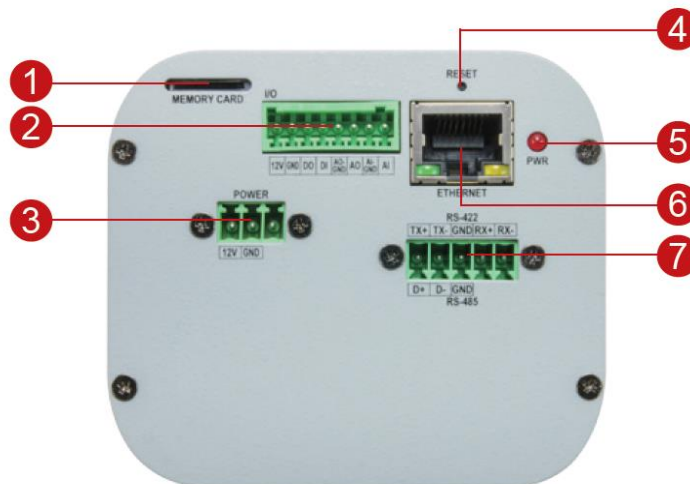

Item	Description
1	<p>Memory Card</p> <p>Insert a memory card into this slot for local recording purposes. See How to Install / Remove the Memory Card on page 28 for more information.</p> <p>NOTE: Support microSDHC and microSDXC cards.</p>

Item	Description
2 Input / Output	
Digital Input / Output (DIDO)	This connector connects to digital input or output devices, such as an alarm trigger, panic button, etc., Digital Input (DI) and Digital Output (DO) devices are used in applications like motion detection, event triggering, alarm notifications, etc. See How to Connect DI/DO Devices on page 17 for more information.
Audio Input / Output	This connector also connects to audio input and output devices, such as microphones and speakers. See How to Connect Audio Devices on page 20 for more information.
3 DC 12V Power Input	In case the camera is connected to a non-PoE (Power over Ethernet) switch, use this connector to connect an external adaptor (not included) to the camera. See Connecting a Power Adapter (Optional) on page 15 for more information.
4 Reset Button	The purpose of reset button is to restore the factory default settings of the camera. See How to Reset the Camera on page 29 for more information.
5 Power LED	The Power LED turns on when the camera is powered on and the system is running.
6 Ethernet Port	Connects to a network using a standard Ethernet cable.
7 Serial Port	This port connects to serial devices via RS-485 or RS-422 protocols. Use the supplied serial port terminal block to connect the wires from the camera to the serial device. See Connecting a Serial Device (Optional) on page 21 for connection details.

E210

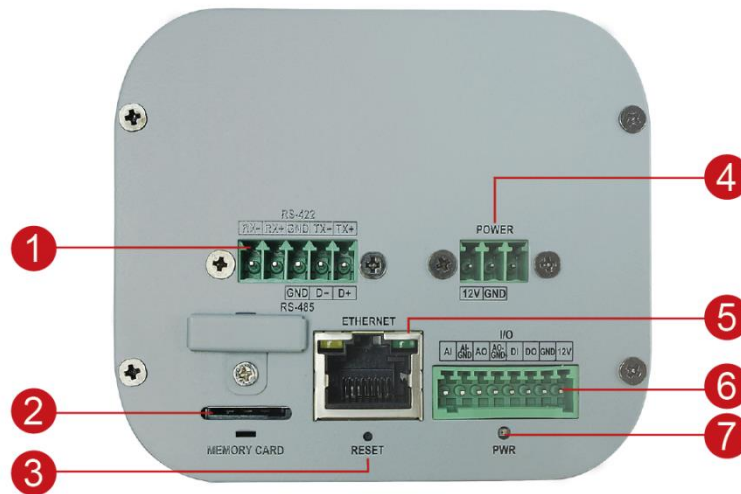

Item	Description
1 Serial Port	This port connects to serial devices via RS-485 or RS-422 protocols. Use the supplied serial port terminal block to connect the wires from the camera to the serial device. See Connecting a Serial Device (Optional) on page 21 for connection details.
2 Memory Card	Insert a memory card into this slot for local recording purposes. See How to Install / Remove the Memory Card on page 28 for more information. NOTE: Support microSDHC and microSDXC cards.
3 Reset Button	The purpose of reset button is to restore the factory default settings of the camera. See How to Reset the Camera on page 29 for more information.
4 DC 12V Power Input	In case the camera is connected to a non-PoE (Power over Ethernet) switch, use this connector to connect an external adaptor (not included) to the camera. See Connecting a Power Adapter (Optional) on page 15 for more information.
5 Ethernet Port	Connects to a network using a standard Ethernet cable.

Item	Description
6 Input / Output	
Digital Input / Output (DIDO)	This connector connects to digital input or output devices, such as an alarm trigger, panic button, etc., Digital Input (DI) and Digital Output (DO) devices are used in applications like motion detection, event triggering, alarm notifications, etc. See How to Connect DI/DO Devices on page 17 for more information.
Audio Input / Output	This connector also connects to audio input and output devices, such as microphones and speakers. See How to Connect Audio Devices on page 20 for more information.
7 Power LED	The Power LED turns on when the camera is powered on and the system is running.

Mounting Options

The camera can be installed both indoors and outdoors. For outdoor installation, additional waterproof housing is required. Below are several mounting options that you can use to install the camera. Select the most suitable solution for your installation environment.

Mount Types	Accessories
Ceiling or Wall (Indoor)	For indoor applications, the camera can be mounted on the ceiling or wall using an indoor bracket (not included in the camera package). You may use the bracket from a local supplier or purchase ACTi's indoor bracket. See Indoor Installation Procedures on page 23 for more information.
	PMAX-1105 
Wall (Outdoor)	A waterproof housing is required when installing the camera outdoors. See the Mounting Accessory Selector for more details.
Pole Mount (Outdoor)	Suitable when mounting the camera on vertical poles. The camera must be enclosed inside the waterproof housing. See the Mounting Accessory Selector for more details.
Corner Mount (Outdoor)	Suitable when mounting the camera on a corner wall. The camera must be enclosed inside the waterproof housing. See the Mounting Accessory Selector for more details.

NOTE:

- For more information about the mounting solutions and accessories, please check the [Mounting Accessory Selector](http://www.acti.com/mountingselector) in our website (<http://www.acti.com/mountingselector>).
- The above mounting accessories are not included in the package. Contact your sales agents to purchase.

Before Installation

This section describes the procedures in preparing the external devices that you can connect to the camera. The camera supports DC12V power input, Digital Input and Output (DI/DO), Audio Input and Output devices, as well as Serial Devices like a Pan-Tilt (PT) Scanner using the bundled terminal blocks. The use of these devices, however, is optional.

Connecting a Power Adapter (Optional)

In case of using a non-PoE switch or your PoE switch has limited power supply, you can purchase a power adapter and directly connect the camera to a power outlet. The power adapter must be connected to the supplied terminal block before use.

To do this, follow the procedures below:

1. Loosen the screws of the **12V** and **GND** pins of the power terminal block.



2. Take note that a standard power adapter cable has two (2) different wires:

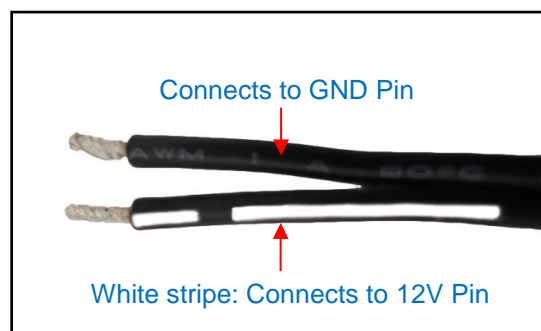

3. Connect the wire with the white stripe to the **12V** pin and the other to the **GND** pin.

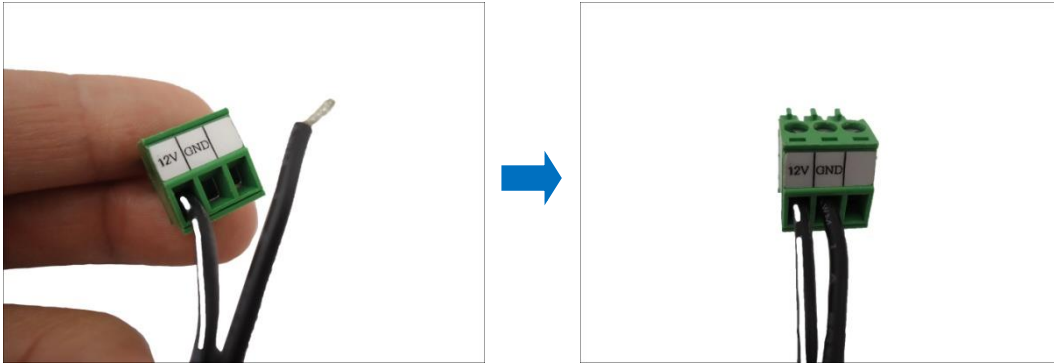

4. Tighten the screws of the **12V** pin and the **GND** pins to secure the wire connection.



5. Set the prepared power adapter for connection later. Below is an example of a power adapter with an attached terminal block.



NOTE: The power adapter is not bundled in the package.

Connecting the DI/DO and Audio Devices (Optional)

Depending on your surveillance needs, you may connect digital input / output or audio input / output devices to your camera. The camera comes with one (1) terminal block for both digital and audio input/output devices.

How to Connect DI/DO Devices

Digital Input (DI) devices can be used to notify the camera about an activity in the camera site. DI can be triggers of events. For example, you can connect a “panic button” to the camera; as such when the panic button is pressed, the alarm signal will be sent through the camera. Other common DI device applications are emergency button, smoke detector, passive infrared sensor, etc.

Digital Output (DO) devices are external devices that are activated by the camera upon an event inside the camera. For example, you can connect an “alarm horn” to the camera; as such when an event occurs inside the camera (e.g. detected intruder), the alarm horn will sound. Other common DO device applications are motion-triggered lights, electric fence, magnetic door locks, etc.

Press and hold the orange tab as you insert the wire through the pin slot, then release the orange tab to secure the wire. The terminal block that comes with the camera may either be labelled as one of the following:

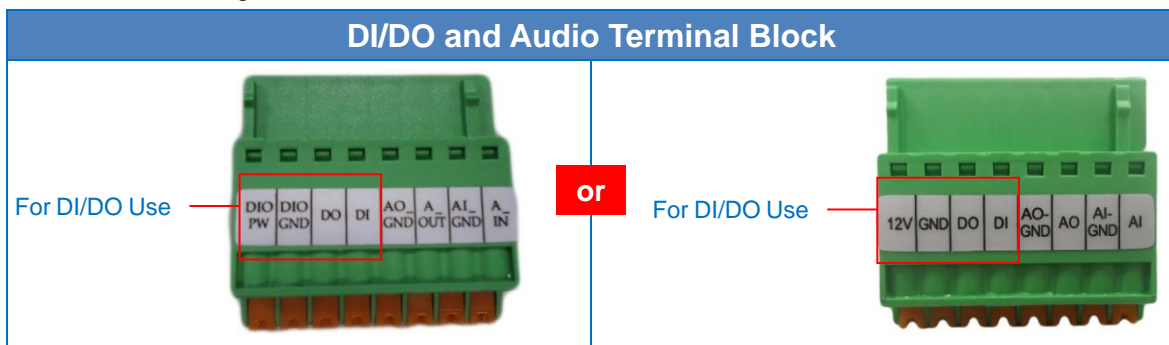

To connect digital input / output devices (DI/DO), map the pins to one of the pin combinations below:

Device	Pin	Mapping Instructions
Digital Output (DO)	DIO PW or 12V	Connect the wires of the output device to DIO PW or 12V and DO .
	DO	
Digital Input (DI)	DIO GND	Connect the wires of the input device to DIO GND and DI .
	DI	

The table below shows the DI/DO connection specifications:

Device			
DI	Connection design		TTL - compatible logic levels
	Voltage	To trigger (low)	Logic level 0: 0V ~ 0.4V
		Normal (high)	Logic level 1: 3.1V ~ 30V
	Current		10mA ~ 100mA
DO	Connection design		Transistor (Open Collector)
	Voltage & Current		< 24V DC, < 50mA

Typical Connection

Based on these specifications, if the DI device has a voltage of 0V ~ 30V or the DO device has a voltage of < 24V (< 50mA), then the camera can supply internal power to these devices and there is no need to connect the DI/DO device to an external power source.

Use the **DIO GND** and **DI** pins to connect a DI device and use the **DIO PW** or **12V** and **DO** pins to connect a DO device. See wiring scheme below:

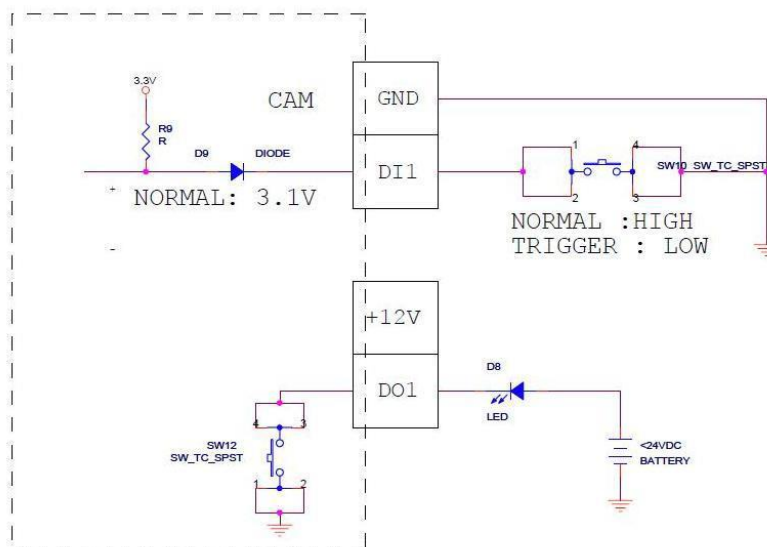

High Voltage DO Device Connection

Even though the camera provides 12V power, this may not be enough for some high voltage DO devices, such as a ceiling light or a motor that opens or closes a gate. In this case, there is a need to connect an external relay. See wiring scheme below:

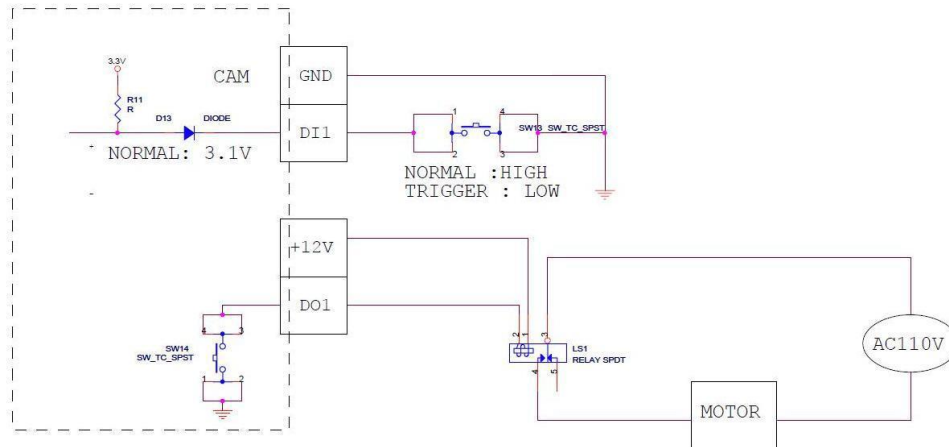

Note that when choosing an appropriate relay, please refer to its specifications and make sure they match the above design. The triggering circuit voltage has to be around 12V DC and the switch-controlled circuit voltage has to match the external power supply (e.g. 110V AC or 220V AC).

The illustration below is a graphic example of connecting a relay to a high voltage DO device.

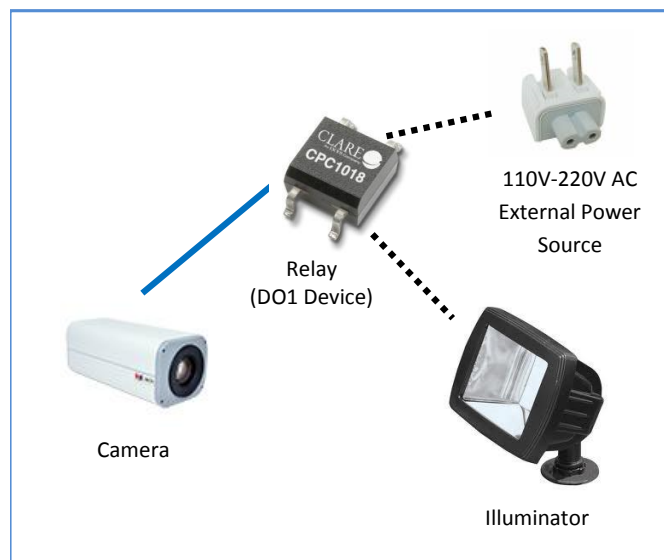

NOTE: For more information on DI/DO connections, please refer to the Knowledge Base article [All about Digital Input and Digital Output](http://www.acti.com/kb/detail.asp?KB_ID=KB20091230001) downloadable from the link below (http://www.acti.com/kb/detail.asp?KB_ID=KB20091230001).

How to Connect Audio Devices

Audio input / output devices, such as an active microphone or speaker can be connected to the camera using the supplied terminal block.

Press and hold the orange tab as you insert the wire through the pin slot, then release the orange tab to secure the wire. The terminal block that comes with the camera may either be labelled as one of the following:



To connect audio devices, map the pins to one of the pin combinations below:

Device	Pin	Mapping Instructions
Audio Output (AO)	AO_GND	Connect the wires of the audio output device to AO_GND and A_OUT or AO .
	A_OUT or AO	
Audio Input (AI)	AI_GND	Connect the wires of the audio input device to AI_GND and A_IN or AI .
	A_IN or AI	

NOTE: For more information about AUDIO in connections, please refer to the Knowledge Base article [How to Use Audio-in of ACTi Cameras](http://www.acti.com/support/KnowledgeBase/outside/detail.asp?KB_ID=KB20100114003), downloadable from the link below (http://www.acti.com/support/KnowledgeBase/outside/detail.asp?KB_ID=KB20100114003).

Connecting a Serial Device (Optional)

The camera can be connected to a **Pan-Tilt (PT) Scanner** (Pan-Tilt Head) using the serial port connector. This allows the zoom camera to do pan and tilt using the Pelco-D protocol. Most PT scanners accept Pelco-D and Pelco-P protocol commands via RS-485 or RS-422 connection, which are both supported by your camera.

Check the connection available on the PT scanner and connect it to your camera following the procedures below.

1. Map the wires from the PT scanner to your camera using the supplied terminal block according to one of the tables below. The terminal block the comes with the camera may either be labelled as one of the following:

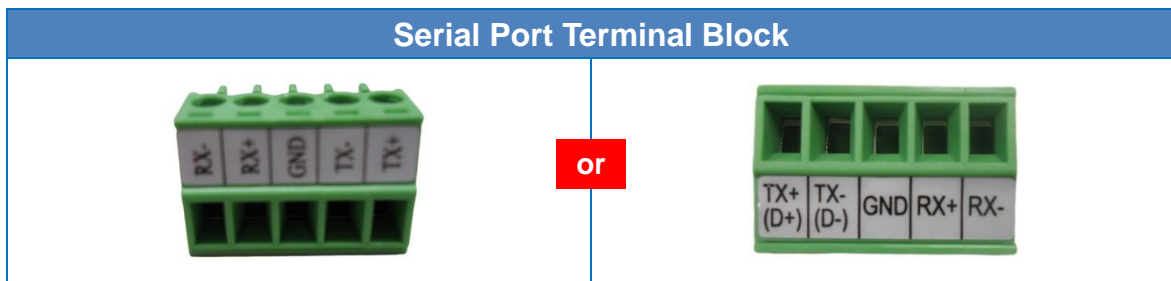

Via RS-485 Connection

Terminal Block		Wire Mapping	
Pin Number / Label		Camera Pin	PT Scanner Pin
1	TX + (D+)	TX + (D+)	DATA +
2	TX – (D-)	TX – (D-)	DATA -
3	GND	GROUND PIN	
4	RX+	-	
5	Rx-	-	

Via RS-422 Connection

Terminal Block		Wire Mapping	
Pin Number / Label		Camera Pin	PT Scanner Pin
1	TX +	TX +	RX +
2	TX -	TX -	RX -
3	GND	GROUND PIN	
4	RX+	RX +	TX +
5	Rx-	RX -	TX -

NOTE: The pins of the PT Scanner may be labeled differently depending on the location or country where the scanner is purchased. For example, some devices may have RS-485

DATA+ pins labeled as “TX+”, “RX+”, “A” or “485+”, etc. Refer to the scanner documentation or contact the manufacturer to verify the corresponding pin labels and ensure proper wiring connection.



CAUTION: Incorrect wiring may cause damage to the connected devices.

DISCLAIMER: ACTi will not be responsible for any damage caused by improper wiring.

2. Connect a ground wire to one of the **GND** terminal pin to complete the connection.

For more information on connecting PT scanners, please refer to the Knowledge Base article:

[Pan and Tilt Scanner for ACTi Zoom Cameras](#)

http://www.acti.com/support/KnowledgeBase/outside/detail.asp?KB_ID=KB20110120001

available on the website.

Indoor Installation Procedures

This section describes the procedures in installing the camera indoors using PMAX-1105 indoor bracket (purchased separately).

When using brackets from other manufacturers, check the installation guide included in the bracket to install the camera.

NOTE: Some pictures in this documentation may slightly differ from the actual camera or accessories.

Step 1: Mount the Indoor Bracket

NOTE: Before installing the bracket, make sure the ceiling or wall can bear more than the weight of the camera and its accessories.

Install the indoor bracket to the ceiling or wall using the three (3) screws included in the bracket package.



Step 2: Attach the Camera to the Bracket

NOTE: The following images show the mounting bracket attached on the bottom side of the camera. Same procedures apply when attaching the mounting bracket on the top side.

1. If necessary, insert a memory card into the memory card slot of the camera with the metal contacts facing down. Push until the card clicks into place. See [How to Install / Remove the Memory Card](#) on page 28 for more information.



2. Slightly loosen the knurled knob.



3. Screw the camera to the bracket.



4. Tighten the hand knob until the camera is secured to the bracket.



5. Adjust the camera angle.



6. Tighten the knurled knob to fix the camera position.



Step 3: Connect the Cable(s)

1. Connect the network cable to the Ethernet port of the camera.



2. If necessary, connect the other external devices, such as DI/DO, PT scanner or power adapter to the camera. See [Before Installation](#) on page 15 for more information.



3. Connect the other end of the network cable to a switch or injector. Then, connect the switch or injector to a network, PC and a power source. See Power-over-Ethernet (PoE) connection example below.

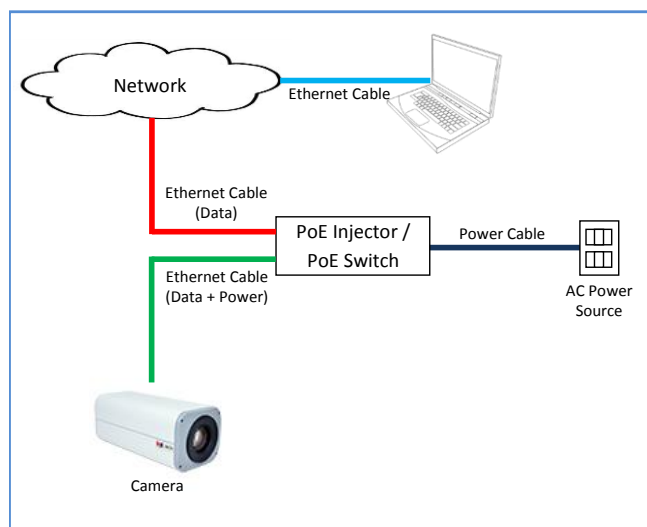

Step 4: Access the Camera Live View

See [Accessing the Camera](#) on page 30 for more information on how to access the Live View of the camera.

Other Adjustments and Accessories

How to Install / Remove the Memory Card

The camera supports local video recording or saving of snapshots to a memory card.

NOTE: Support microSDHC and microSDXC cards.

How to Insert the Memory Card

Insert a memory card into the card slot with the metallic contacts facing down the camera. Push the card until it clicks into place.

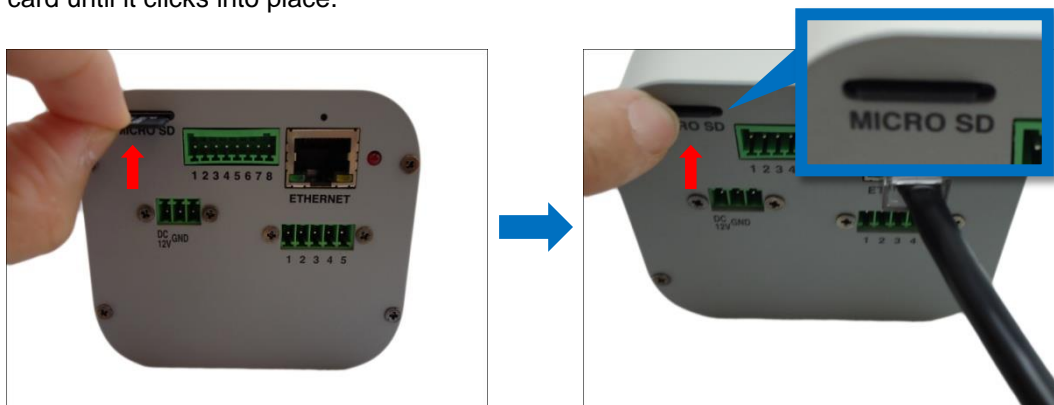

For E210, after inserting the memory card, use the slot cover to close the memory card slot.

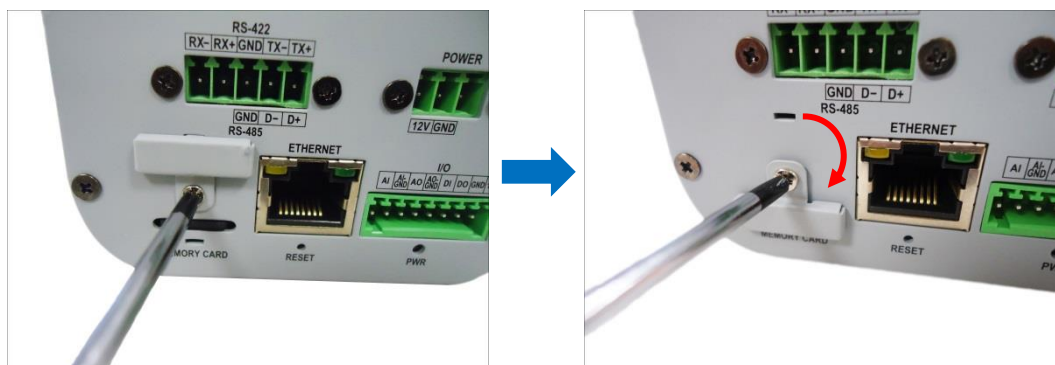

How to Remove the Memory Card

In case there is a need to remove the card, make sure to access the camera Web Configurator to safely “unmount” the card first (see the camera Firmware manual for more information). Once unmounted from the firmware, push the card to eject it from the slot.

How to Reset the Camera

The purpose of reset button is to restore the factory default settings of the camera, including administrator's password.

The reset button can be used for following purposes:

1. The administrator's password has been forgotten and therefore the camera cannot be accessed.
2. In case of IP address, mask, or allow/deny filter related issues, resulting with inability to modify these settings.
3. In case of connectivity issues or abnormal video quality.

How to do the reset?

Using a pointed object, such as a paper clip, press and hold the reset button for at least 5 seconds or until the Power LED goes off.

Accessing the Camera

Configure the IP Addresses

In order to be able to communicate with the camera from your PC, both the camera and the PC have to be within the same network segment. In most cases, it means that they both should have very similar IP addresses, where only the last number of the IP address is different from each other. There are 2 different approaches to IP Address management in Local Area Networks – by DHCP Server or Manually.

Using DHCP server to assign IP addresses:

If you have connected the computer and the camera into the network that has a DHCP server running, then you do not need to configure the IP addresses at all – both the camera and the PC would request a unique IP address from DHCP server automatically. In such case, the camera will immediately be ready for the access from the PC. The user, however, might not know the IP address of the camera yet. It is necessary to know the IP address of the camera in order to be able to access it by using a Web browser.

The quickest way to discover the cameras in the network is to use the simplest network search, built in the Windows system – just by pressing the “Network” icon, all the cameras of the local area network will be discovered by Windows thanks to the UPnP function support of our cameras.

In the example below, we successfully the camera model that we had just connected to the network.

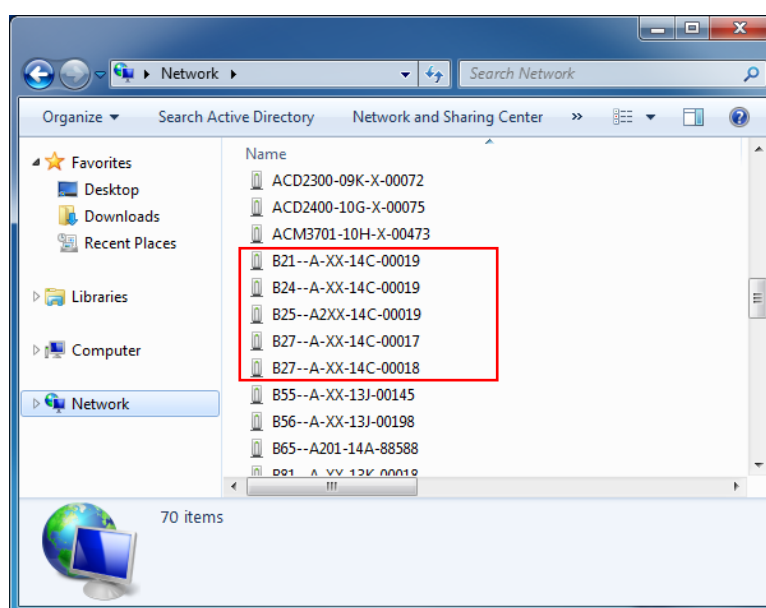

Double-click the mouse button on the camera model, the default browser of the PC is automatically launched and the IP address of the target camera is already filled in the address bar of the browser.

If you work with our cameras regularly, then **there is even a better way to discover the cameras in the network** – by using **IP Utility**. The IP Utility is a light software tool that can not only discover the cameras, but also list lots of valuable information, such as IP and MAC addresses, serial numbers, firmware versions, etc, and allows quick configuration of multiple devices at the same time.

The IP Utility can be downloaded for free from http://www.acti.com/IP_Utility.

With just one click, you can launch the IP Utility and there will be an instant report as follows:

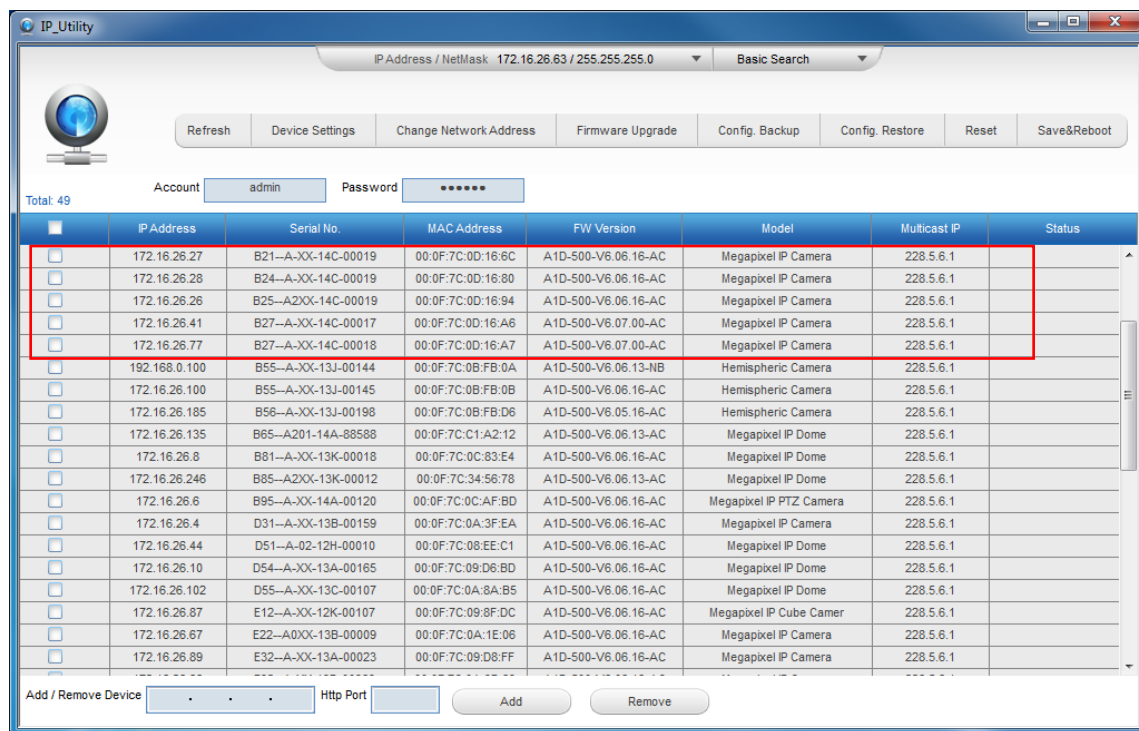

You can quickly notice the camera model in the list. Click on the IP address to automatically launch the default browser of the PC with the IP address of the target camera filled in the address bar of the browser already.

Use the default IP address of a camera:

If there is no DHCP server in the given network, the user may have to assign the IP addresses to both PC and camera manually to make sure they are in the same network segment.

When the camera is plugged into network and it does not detect any DHCP services, it will automatically assign itself a default IP:

192.168.0.100

Whereas the default port number would be **80**. In order to access that camera, the IP address of the PC has to be configured to match the network segment of the camera.

Manually adjust the IP address of the PC:

In the following example, based on Windows 7, we will configure the IP address to **192.168.0.99** and set Subnet Mask to **255.255.255.0** by using the steps below:

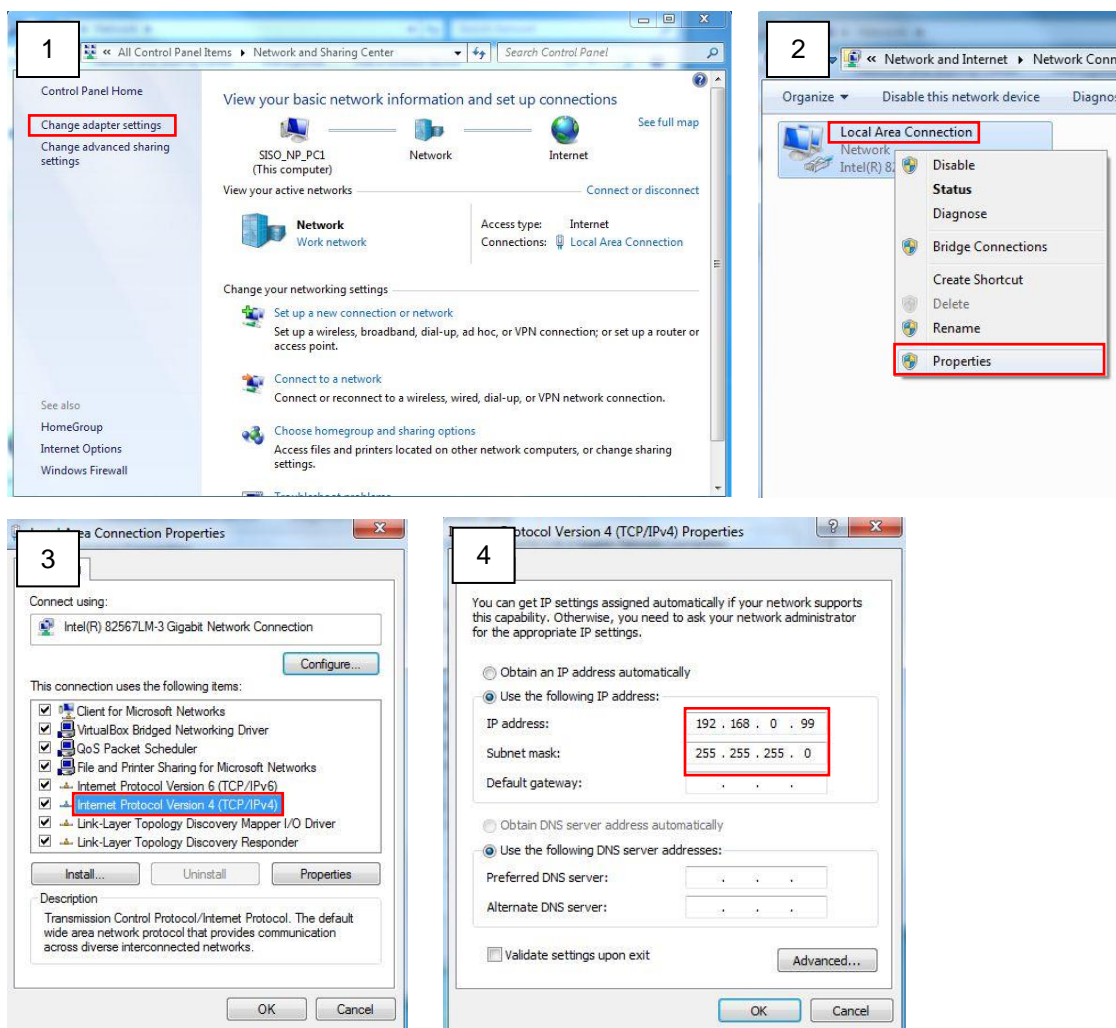

Manually adjust the IP addresses of multiple cameras:

If there are more than 1 camera to be used in the same local area network and there is no DHCP server to assign unique IP addresses to each of them, all of the cameras would then have the initial IP address of **192.168.0.100**, which is not a proper situation for network devices – all the IP addresses have to be different from each other. The easiest way to assign cameras the IP addresses is by using **IP Utility**:

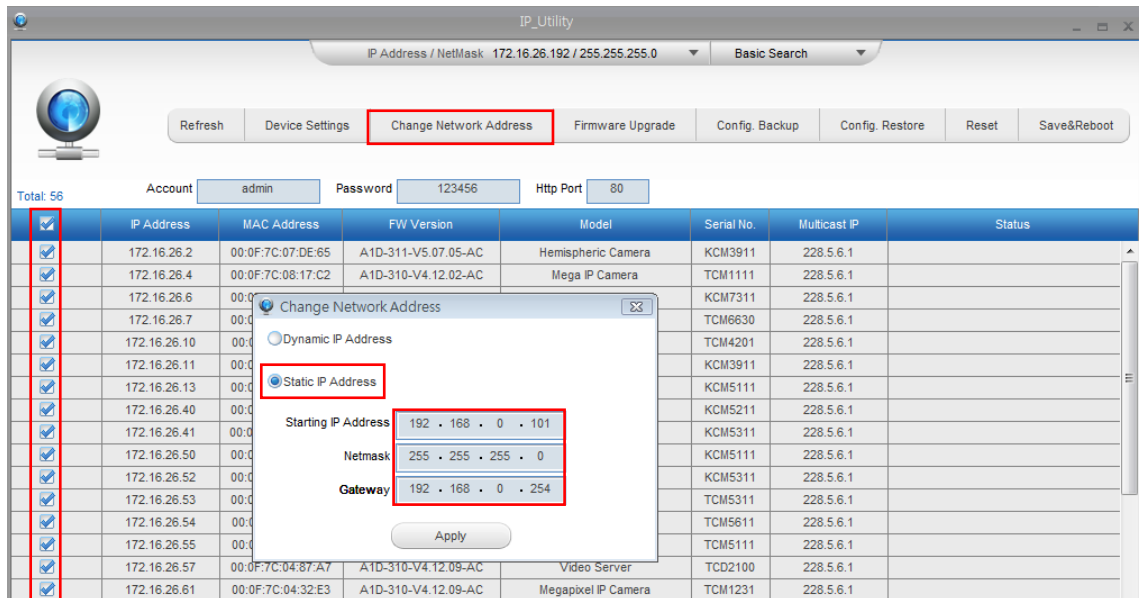

With the procedure shown above, all the cameras will have unique IP addresses, starting from 192.168.0.101. In case there are 20 cameras selected, the last one of the cameras would have the IP 192.168.0.120.

Later, by pressing the “Refresh” button of the IP Utility, you will be able to see the list of cameras with their new IP addresses.

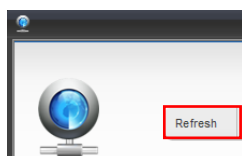

Please note that it is also possible to change the IP addresses manually by using the Web browser. In such case, please plug in only one camera at a time, and change its IP address by using the Web browser before plugging in the next one. This way, the Web browser will not be confused about two devices having the same IP address at the same time.

Access the Camera

Now that the camera and the PC are both having their unique IP addresses and are under the same network segment, it is possible to use the Web browser of the PC to access the camera.

You can use **any of the browsers** to access the camera, however, the full functionality is provided only for **Microsoft Internet Explorer**.

The browser functionality comparison:

Functionality	Internet Explorer	Other browsers
Live Video	Yes	Yes*
Live Video Area Resizable	Yes	No
PTZ Control	Yes	Yes
Capture the snapshot	Yes	Yes
Video overlay based configuration (Motion Detection regions, Privacy Mask regions)	Yes	No
All the other configurations	Yes	Yes

* When using non-Internet Explorer browsers, free third-party software plug-ins must be installed to the PC first to be able to get the live video feed from the camera:

Browser	Required Plug-In
Safari	QuickTime (http://www.apple.com/quicktime/download/)
Other non-Internet Explorer browsers	Basic VLC Media Player (http://www.videolan.org)

***Disclaimer Notice:** The camera manufacturer does not guarantee the compatibility of its cameras with VLC player or QuickTime – since these are third party softwares. The third party has the right to modify their utility any time which might affect the compatibility. In such cases, please use Internet Explorer browser instead.*

When using Internet Explorer browser, the ActiveX control for video stream management will be downloaded from the camera directly – the user just has to accept the use of such control when prompted so. No other third party utilities are required to be installed in such case.

The following examples in this manual are based on Internet Explorer browser in order to cover all functions of the camera.

Assuming that the camera's IP address is **192.168.0.100**, you can access it by opening the Web browser and typing the following address into Web browser's address bar:

http://192.168.0.100

Upon successful connection to the camera, the user interface called **Web Configurator** would appear together with the login page. The HTTP port number was not added behind the IP address since the default HTTP port of the camera is 80, which can be omitted from the address for convenience.

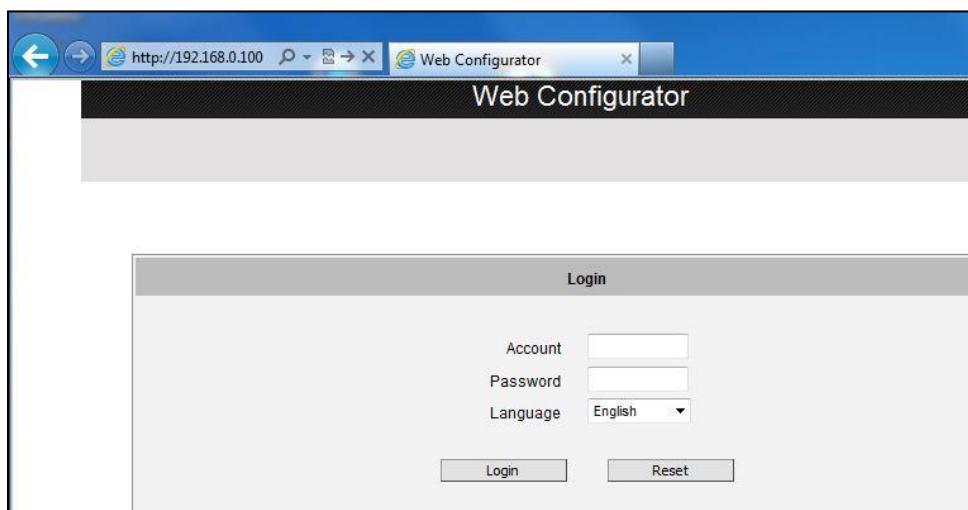

Before logging in, you need to know the factory default Account and Password of the camera.

Account: **Admin**

Password: **123456**



Copyright © 2016, ACTi Corporation All Rights Reserved

7F, No. 1, Alley 20, Lane 407, Sec. 2, Ti-Ding Blvd., Neihu District, Taipei, Taiwan 114, R.O.C.

TEL : +886-2-2656-2588 FAX : +886-2-2656-2599

Email: sales@acti.com