

User's Guide

Copyright

Copyright

No part of this publication may be reproduced, stored in a retrieval system, or transmitted in any form or by any means, electronic, mechanical, photocopying, recording, or otherwise, without the prior written permission of Seiko Epson Corporation. No patent liability is assumed with respect to the use of the information contained herein. Neither is any liability assumed for damages resulting from the use of the information herein. The information contained herein is designed only for use with this Epson printer. Epson is not responsible for any use of this information as applied to other printers.

Neither Seiko Epson Corporation nor its affiliates shall be liable to the purchaser of this product or third parties for damages, losses, costs, or expenses incurred by the purchaser or third parties as a result of accident, misuse, or abuse of this product or unauthorized modifications, repairs, or alterations to this product, or (excluding the U.S.) failure to strictly comply with Seiko Epson Corporation's operating and maintenance instructions.

Seiko Epson Corporation and its affiliates shall not be liable for any damages or problems arising from the use of any options or any consumable products other than those designated as Original Epson Products or Epson Approved Products by Seiko Epson Corporation.

Seiko Epson Corporation shall not be held liable for any damage resulting from electromagnetic interference that occurs from the use of any interface cables other than those designated as Epson Approved Products by Seiko Epson Corporation.

© 2014 Seiko Epson Corporation. All rights reserved.

The contents of this manual and the specifications of this product are subject to change without notice.

Trademarks

- ❑ EPSON® is a registered trademark, and EPSON EXCEED YOUR VISION or EXCEED YOUR VISION is a trademark of Seiko Epson Corporation.
- ❑ PRINT Image Matching™ and the PRINT Image Matching logo are trademarks of Seiko Epson Corporation. Copyright © 2001 Seiko Epson Corporation. All rights reserved.
- ❑ EPSON Scan software is based in part on the work of the Independent JPEG Group.

- ❑ libtiff

Copyright © 1988-1997 Sam Leffler

Copyright © 1991-1997 Silicon Graphics, Inc.

Permission to use, copy, modify, distribute, and sell this software and its documentation for any purpose is hereby granted without fee, provided that (i) the above copyright notices and this permission notice appear in all copies of the software and related documentation, and (ii) the names of Sam Leffler and Silicon Graphics may not be used in any advertising or publicity relating to the software without the specific, prior written permission of Sam Leffler and Silicon Graphics.

THE SOFTWARE IS PROVIDED "AS-IS" AND WITHOUT WARRANTY OF ANY KIND, EXPRESS, IMPLIED OR OTHERWISE, INCLUDING WITHOUT LIMITATION, ANY WARRANTY OF MERCHANTABILITY OR FITNESS FOR A PARTICULAR PURPOSE.

IN NO EVENT SHALL SAM LEFFLER OR SILICON GRAPHICS BE LIABLE FOR ANY SPECIAL, INCIDENTAL, INDIRECT OR CONSEQUENTIAL DAMAGES OF ANY KIND, OR ANY DAMAGES WHATSOEVER RESULTING FROM LOSS OF USE, DATA OR PROFITS, WHETHER OR NOT ADVISED OF THE POSSIBILITY OF DAMAGE, AND ON ANY THEORY OF LIABILITY, ARISING OUT OF OR IN CONNECTION WITH THE USE OR PERFORMANCE OF THIS SOFTWARE.

- ❑ Microsoft®, Windows®, and Windows Vista® are registered trademarks of Microsoft Corporation.
- ❑ Apple, Macintosh, Mac OS, OS X, Bonjour, Safari, iPad, iPhone, iPod touch, and iTunes are trademarks of Apple Inc., registered in the U.S. and other countries.
- ❑ Chrome™, Chrome OS™, and Android™ are trademarks of Google Inc.
- ❑ Adobe, Adobe Reader, Acrobat, and Photoshop are trademarks of Adobe systems Incorporated, which may be registered in certain jurisdictions.
- ❑ Intel® is a registered trademark of Intel Corporation.
- ❑ General Notice: Other product names used herein are for identification purposes only and may be trademarks of their respective owners. Epson disclaims any and all rights in those marks.

Contents

Copyright

Trademarks

About This Manual

Introduction to the Manuals.	7
Marks and Symbols.	7
Descriptions Used in this Manual.	7
Operating System References.	8

Important Instructions

Safety Instructions.	9
Printer Advisories and Warnings.	9
Advisories and Warnings for Setting Up/ Using the Printer.	9
Advisories and Warnings for Using the Printer with a Wireless Connection.	11

Printer Basics

Part Names and Functions.	12
Control Panel.	14

Loading Paper

Paper Handling Precautions.	16
Available Paper and Capacities.	17
List of Paper Types.	18
Loading Paper in the Rear Paper Feed.	18

Placing Originals on the Scanner Glass

Printing

Printing from a Computer.	24
Printing Basics - Windows.	24
Printing Basics - Mac OS X.	25
Printing on 2-Sides (for Windows only).	28
Printing Several Pages on One Sheet.	29
Printing to Fit the Paper Size.	30
Printing Multiple Files Together (for Windows Only).	31
Enlarged Printing and Making Posters (for Windows Only).	32

Printing Using Advanced Features.	38
Printing Photos Using Epson Easy Photo Print.	40
Printing from Smart Devices.	41
Using Epson iPrint.	41
Canceling Printing.	42
Canceling Printing - Printer Button.	42
Canceling Printing - Windows.	42
Canceling Printing - Mac OS X.	43

Copying

Copying Basics.	44
Making 20 Copies.	44

Scanning

Scanning from the Control Panel.	45
Scanning from a Computer.	45
Scanning Basics.	45
Scanning Using Advanced Features.	48
Scanning from Smart Devices.	51

Replacing Ink Cartridges

Checking the Ink Levels.	53
Checking the Ink Levels - Windows.	53
Checking the Ink Levels - Mac OS X.	53
Ink Cartridge Codes.	53
Ink Cartridge Handling Precautions.	54
Replacing Ink Cartridges.	56
Temporarily Printing with Black Ink.	60
Temporarily Printing with Black Ink - Windows.	61
Temporarily Printing with Black Ink - Mac OS X.	62
Conserving Black Ink when the Black Ink Is Low (for Windows Only).	63

Improving Print and Scan Quality

Checking and Cleaning the Print Head.	64
Checking and Cleaning the Print Head - Printer Buttons.	64
Checking and Cleaning the Print Head - Windows.	65
Checking and Cleaning the Print Head - Mac OS X.	65
Aligning the Print Head.	66

Contents

Aligning the Print Head - Windows.	66	An Image of the Reverse Side of the Original Appears in the Copied Image.	89
Aligning the Print Head - Mac OS X.	66	The Position, Size, or Margins of the Printout Are Incorrect.	89
Cleaning the Paper Path.	66	Paper Is Smeared or Scuffed.	90
Cleaning the Scanner Glass.	67	Printed Characters Are Incorrect or Garbled.	90
		The Printed Image Is Inverted.	90
		The Printout Problem Could Not be Cleared.	91
Applications and Network Service Information		Printing Is Too Slow.	91
Epson Connect Service.	68	Cannot Start Scanning.	91
Web Config.	68	Cannot Start Scanning when Using the Control Panel.	92
Running Web Config on a Web Browser.	68	Scanned Image Problems.	92
Running Web Config on Windows.	69	Scan Quality Is Poor.	92
Running Web Config on Mac OS X.	69	Characters Are Blurred.	93
Necessary Applications.	69	An Image of the Reverse Side of the Original Appears in the Scanned Image.	93
Windows Printer Driver.	69	Moire (Cross-Hatch) Patterns Appear in the Scanned Image.	93
Mac OS X Printer Driver.	73	Scanning Area or Direction Is Not Correct.	93
EPSON Scan (Scanner Driver).	76	The Scanned Image Problem Could Not be Cleared.	94
Epson Event Manager.	76	Other Scanning Problems.	94
Epson Easy Photo Print.	77	Cannot Scan in Full Auto Mode in EPSON Scan.	94
E-Web Print (for Windows Only).	77	Thumbnail Preview Does Not Work Properly.	94
Easy Photo Scan.	77	Scanning Is Too Slow.	94
EPSON Software Updater.	78	Scanning Stops when Scanning to PDF/ Multi-TIFF.	95
Uninstalling Applications.	78	Other Problems.	95
Uninstalling Applications - Windows.	78	Slight Electric Shock when Touching the Printer.	95
Uninstalling Applications - Mac OS X.	79	Operation Sounds Are Loud.	95
Installing Applications.	79	Application Is Blocked by a Firewall (for Windows Only).	95
Updating Applications and Firmware.	80		
		Appendix	
Solving Problems		Technical Specifications.	96
Checking the Printer Status.	81	Printer Specifications.	96
Checking the Error Indicators on the Printer.	81	Scanner Specifications.	97
Checking the Printer Status - Windows.	82	Interface Specifications.	97
Checking Printer Status - Mac OS X.	83	Wi-Fi Specifications.	97
Removing Jammed Paper.	83	Security Protocol.	98
Removing Jammed Paper from the Rear Paper Feed.	83	Dimensions.	98
Removing Jammed Paper from the Output Tray.	84	Electrical Specifications.	98
Removing Jammed Paper from Inside the Printer.	84	Environmental Specifications.	99
Paper Does Not Feed Correctly.	86	System Requirements.	99
Power and Control Panel Problems.	86	Regulatory Information.	99
Power Does Not Turn On.	86	Standards and Approvals.	99
Power Does Not Turn Off.	86	Restrictions on Copying.	101
Printer Does Not Print.	86		
Printout Problems.	87		
Print Quality Is Poor.	87		
Copy Quality Is Poor.	89		

Contents

Saving Power. 101
 Saving Power - Windows.101
 Saving Power - Mac OS X. 102
Transporting the Printer. 102
Where to Get Help. 104
 Technical Support Web Site.104
 Contacting Epson Support. 104

About This Manual

Introduction to the Manuals

The latest versions of the following manuals are available from the Epson support website.

<http://www.epson.eu/Support> (Europe)

<http://support.epson.net/> (outside Europe)

Start Here (paper manual)

Provides you with information on setting up the printer and installing the software.

User's Guide (digital manual)

This manual. Provides instructions on using the printer, replacing ink cartridges, maintenance, and solving problems.

Network Guide (digital manual)

Provides information on network settings and solving problems when using the printer on a network.

As well as the manuals above, see the help included in the various Epson software applications.

Marks and Symbols



Caution:

Instructions that must be followed carefully to avoid bodily injury.



Important:

Instructions that must be observed to avoid damage to your equipment.

Note:

Instructions containing useful tips and restrictions on printer operation.

➔ Related Information

Links to related sections.

Descriptions Used in this Manual

Screenshots of the printer driver and the EPSON Scan (scanner driver) screens are from Windows 8.1 or Mac OS X v10.9.x. The content displayed on the screens varies depending on the model and situation.

Illustrations of the printer used in this manual are examples only. Although there may be slight differences depending on the model, the method of operation is the same.

Operating System References

Windows

In this manual, terms such as "Windows 8.1", "Windows 8", "Windows 7", "Windows Vista", and "Windows XP" refer to the following operating systems. Additionally, "Windows" is used to refer to all versions.

- Microsoft® Windows® 8.1 operating system
- Microsoft® Windows® 8 operating system
- Microsoft® Windows® 7 operating system
- Microsoft® Windows Vista® operating system
- Microsoft® Windows® XP operating system
- Microsoft® Windows® XP Professional x64 Edition operating system

Mac OS X

In this manual, "Mac OS X v10.9.x" refers to "OS X Mavericks" and "Mac OS X v10.8.x" refers to "OS X Mountain Lion". Additionally, "Mac OS X" is used to refer to "Mac OS X v10.9.x", "Mac OS X v10.8.x", "Mac OS X v10.7.x" and "Mac OS X v10.6.x".

Important Instructions

Safety Instructions

Read and follow these instructions to ensure safe use of this printer. Make sure you keep this manual for future reference. Also, be sure to follow all warnings and instructions marked on the printer.

- Use only the power cord supplied with the printer and do not use the cord with any other equipment. Use of other cords with this printer or the use of the supplied power cord with other equipment may result in fire or electric shock.
- Be sure your AC power cord meets the relevant local safety standard.
- Never disassemble, modify, or attempt to repair the power cord, plug, printer unit, scanner unit, or options by yourself, except as specifically explained in the printer's manuals.
- Unplug the printer and refer servicing to qualified service personnel under the following conditions:
The power cord or plug is damaged; liquid has entered the printer; the printer has been dropped or the casing damaged; the printer does not operate normally or exhibits a distinct change in performance. Do not adjust controls that are not covered by the operating instructions.
- Place the printer near a wall outlet where the plug can be easily unplugged.
- Do not place or store the printer outdoors, near excessive dirt or dust, water, heat sources, or in locations subject to shocks, vibrations, high temperature or humidity.
- Take care not to spill liquid on the printer and not to handle the printer with wet hands.
- Keep the printer at least 22 cm away from cardiac pacemakers. Radio waves from this printer may adversely affect the operation of cardiac pacemakers.
- Be careful when you handle used ink cartridges, as there may be some ink around the ink supply port.
 - If ink gets on your skin, wash the area thoroughly with soap and water.
 - If ink gets into your eyes, flush them immediately with water. If discomfort or vision problems continue after a thorough flushing, see a doctor immediately.
 - If ink gets into your mouth, see a doctor right away.
- Do not disassemble the ink cartridge; otherwise ink may get into your eyes or on your skin.
- Do not shake ink cartridges too vigorously and do not drop them. Also, be careful not to squeeze them or tear their labels. Doing so may cause ink leakage.
- Keep ink cartridges out of the reach of children.



Printer Advisories and Warnings

Read and follow these instructions to avoid damaging the printer or your property. Make sure you keep this manual for future reference.

Advisories and Warnings for Setting Up/Using the Printer

- Do not block or cover the vents and openings in the printer.
- Use only the type of power source indicated on the printer's label.

Important Instructions

- ❑ Avoid using outlets on the same circuit as photocopiers or air control systems that regularly switch on and off.
- ❑ Avoid electrical outlets controlled by wall switches or automatic timers.
- ❑ Keep the entire computer system away from potential sources of electromagnetic interference, such as loudspeakers or the base units of cordless telephones.
- ❑ The power-supply cords should be placed to avoid abrasions, cuts, fraying, crimping, and kinking. Do not place objects on top of the power-supply cords and do not allow the power-supply cords to be stepped on or run over. Be particularly careful to keep all the power-supply cords straight at the ends and the points where they enter and leave the transformer.
- ❑ If you use an extension cord with the printer, make sure that the total ampere rating of the devices plugged into the extension cord does not exceed the cord's ampere rating. Also, make sure that the total ampere rating of all devices plugged into the wall outlet does not exceed the wall outlet's ampere rating.
- ❑ If you plan to use the printer in Germany, the building installation must be protected by a 10 or 16 amp circuit breaker to provide adequate short-circuit protection and over-current protection for the printer.
- ❑ When connecting the printer to a computer or other device with a cable, ensure the correct orientation of the connectors. Each connector has only one correct orientation. Inserting a connector in the wrong orientation may damage both devices connected by the cable.
- ❑ Place the printer on a flat, stable surface that extends beyond the base of the printer in all directions. The printer will not operate properly if it is tilted at an angle.
- ❑ When storing or transporting the printer, avoid tilting it, placing it vertically, or turning it upside down; otherwise ink may leak.
- ❑ Allow space above the printer so that you can fully raise the document cover.
- ❑ Leave enough space in front of the printer for the paper to be fully ejected.
- ❑ Avoid places subject to rapid changes in temperature and humidity. Also, keep the printer away from direct sunlight, strong light, or heat sources.
- ❑ Do not insert objects through the slots in the printer.
- ❑ Do not put your hand inside the printer during printing.
- ❑ Do not touch the white flat cable inside the printer.
- ❑ Do not use aerosol products that contain flammable gases inside or around the printer. Doing so may cause fire.
- ❑ Do not move the print head by hand; otherwise, you may damage the printer.
- ❑ Be careful not to trap your fingers when closing the scanner unit.
- ❑ Do not press too hard on the scanner glass when placing the originals.
- ❑ Always turn the printer off using the  button. Do not unplug the printer or turn off the power at the outlet until the  light stops flashing.
- ❑ Before transporting the printer, make sure that the print head is in the home (far right) position and the ink cartridges are in place.
- ❑ If you are not going to use the printer for a long period, be sure to unplug the power cord from the electrical outlet.

Important Instructions

Advisories and Warnings for Using the Printer with a Wireless Connection

- ❑ Radio waves from this printer may negatively affect the operation of medical electronic equipment, causing them to malfunction. When using this printer inside medical facilities or near medical equipment, follow directions from the authorized personnel representing the medical facilities, and follow all posted warnings and directions on the medical equipment.
- ❑ Radio waves from this printer may negatively affect the operation of automatically controlled devices such as automatic doors or fire alarms, and could lead to accidents due to malfunction. When using this printer near automatically controlled devices, follow all posted warnings and directions on these devices.

Printer Basics

Part Names and Functions

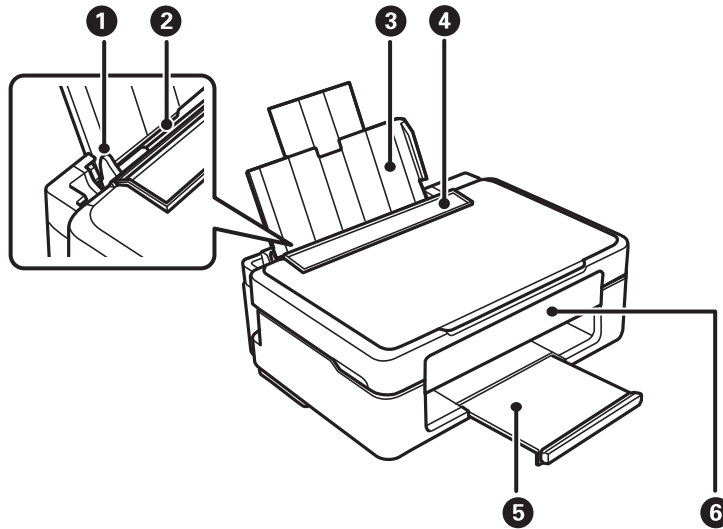

1	Edge guide	Feeds the paper straight into the printer. Slide to the edges of the paper.
2	Rear paper feed	Loads paper.
3	Paper support	Supports loaded paper.
4	Feeder guard	Prevents foreign substance from entering the printer. Usually keep this guard closed.
5	Output tray	Holds the ejected paper.
6	Control panel	Operates the printer.

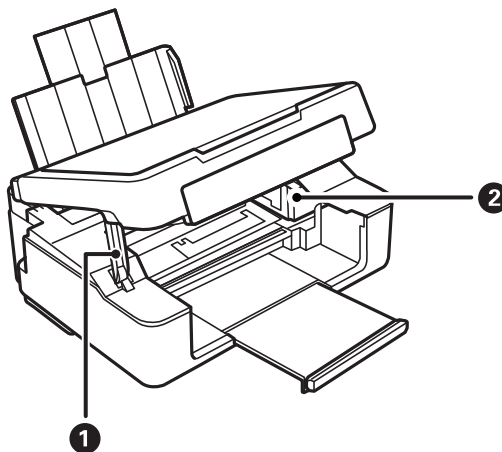

1	Scanner unit support	Supports the scanner unit.
---	----------------------	----------------------------

Printer Basics

<p>2</p>	<p>Ink cartridge holder</p>	<p>Install the ink cartridges. Ink is ejected from the print head nozzles underneath.</p>
----------	-----------------------------	---

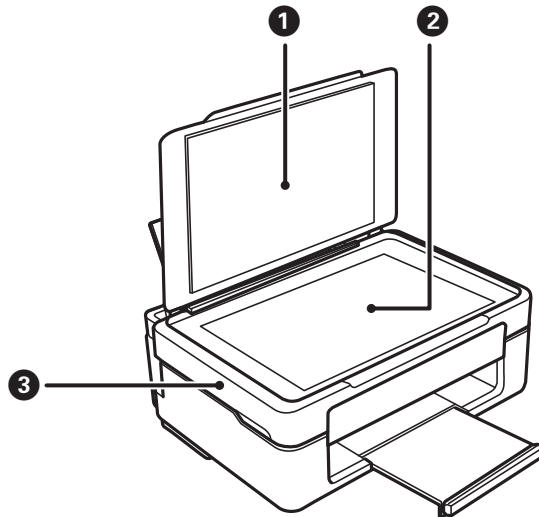

<p>1</p>	<p>Document cover</p>	<p>Blocks external light while scanning.</p>
<p>2</p>	<p>Scanner glass</p>	<p>Place the originals.</p>
<p>3</p>	<p>Scanner unit</p>	<p>Scans placed originals. Open when replacing ink cartridges or removing jammed paper inside the printer.</p>

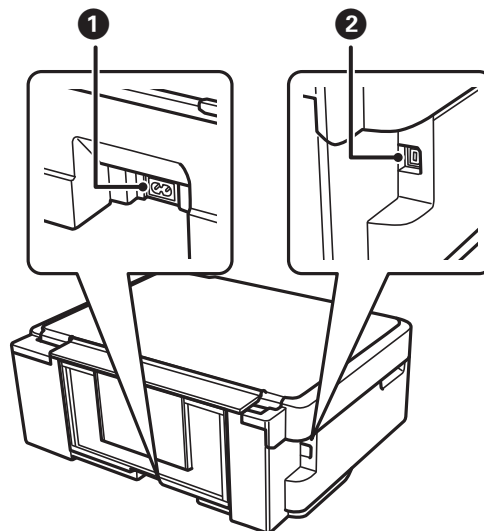







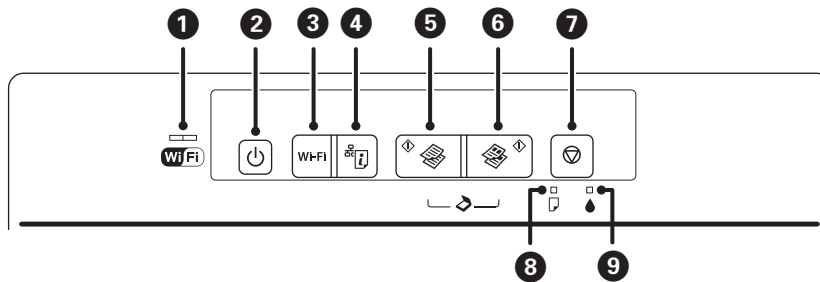



<p>1</p>	<p>AC inlet</p>	<p>Connects the power cord.</p>
<p>2</p>	<p>USB port</p>	<p>Connects a USB cable.</p>

Printer Basics



















Control Panel



<p>1</p> 	<p>The left and right lights indicate the network status.</p> <ul style="list-style-type: none"> <input type="checkbox"/> Green light - left: Turns on while the printer is trying to connect to a wireless (Wi-Fi) network, or flashes while communicating. <input type="checkbox"/> Orange light - right: Flashes when a problem with the printer's wireless (Wi-Fi) network connection occurs. <p>The lights flash alternately or simultaneously while initializing or making network settings.</p>
<p>2</p> 	<p>Turns the printer on or off.</p> <p>Do not turn off while the power light is flashing (while the printer is operating or processing data).</p> <p>Unplug the power cord when the power light is off.</p>
<p>3</p> <p>Wi-Fi</p>	<p>When a network error occurs, pressing this button cancels the error. Hold this button down for more than three seconds to perform Wi-Fi auto setup using the WPS push button.</p> <p>See the <i>Network Guide</i> for more details.</p>
<p>4</p> 	<p>Prints the network status sheet allowing you to check the network settings and connection status. The PIN code for PIN Code Setup (WPS) is also printed.</p>
<p>5</p> 	<p>Starts monochrome copying on A4 size plain paper.</p> <p>Hold this button down for three seconds to start monochrome copying in draft mode.</p> <p>For users in Belgium, the draft mode is not available.</p>
<p>6</p> 	<p>Starts color copying on A4 size plain paper.</p> <p>Hold this button down for three seconds to start color copying in draft mode.</p> <p>For users in Belgium, the draft mode is not available.</p>
<p>7</p> 	<p>Stops the current operation.</p> <p>Hold this button down for three seconds until the  button flashes to run print head cleaning.</p> <p>When the  light turns on, press this button to replace the ink cartridges. When the  light flashes or turns off, hold this button down for six seconds to replace the cartridge.</p>
<p>8</p> 	<p>Turns on or flashes when paper is out or a paper jam occurs.</p>
<p>9</p> 	<p>Turns on when an ink cartridge error occurs, such as the ink cartridge needs to be replaced. Flashes when the ink is low.</p>

Additional functions are available with different combinations of buttons.

Printer Basics

 + 	<p>Press  and  buttons simultaneously to run software on a USB-connected computer and scan as a PDF file.</p>
 +  or 	<p>Press  and the  or  buttons simultaneously to make 20 copies.</p>
<p>Wi-Fi + </p>	<p>Press the Wi-Fi and  buttons simultaneously to start PIN Code Setup (WPS). See the <i>Network Guide</i> for more details.</p>
 + 	<p>Turn the printer on while holding down the  button to restore the default network settings.</p>
 + 	<p>Turn the printer on while holding down the  button to print the nozzle check pattern.</p>

Related Information

➔ [“Checking the Error Indicators on the Printer” on page 81](#)

Loading Paper

Paper Handling Precautions

- ❑ Read the instruction sheets supplied with the paper.
- ❑ Fan and align the edges of the paper before loading. Do not fan or curl photo paper. Doing so may damage the printable side.

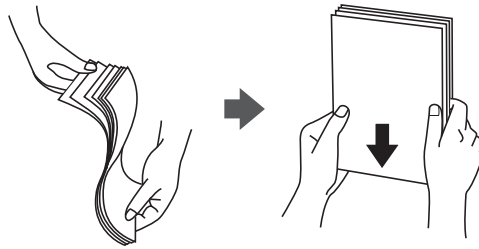

- ❑ If the paper is curled, flatten it or curl it slightly in the opposite direction before loading. Printing on curled paper may cause paper jams and smears on the printout.

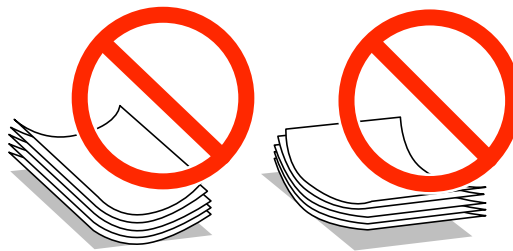

- ❑ Do not use paper that is wavy, torn, cut, folded, damp, too thick, too thin, or paper that has stickers stuck to it. Using these types of paper causes paper jams and smears on the printout.
- ❑ Fan and align the edges of the envelopes before loading. When the stacked envelopes are puffed up with air, press them down to flatten them before loading.

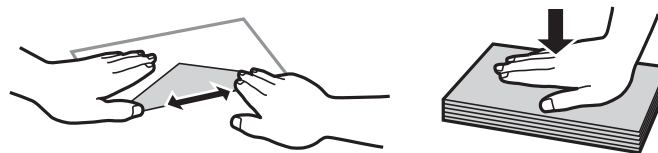

- ❑ Do not use envelopes that are curled or folded. Using these envelopes causes paper jams and smears on the printout.
- ❑ Do not use envelopes with adhesive surfaces on the flaps or window envelopes.
- ❑ Avoid using envelopes that are too thin, as they may curl during printing.

Related Information

- ➔ [“Printer Specifications” on page 96](#)

Loading Paper

Available Paper and Capacities

Epson recommends using genuine Epson paper to ensure high-quality printouts. The only paper size and paper type available for printing from the control panel are A4 size and plain paper.

Genuine Epson Paper

Media Name	Size	Loading Capacity (Sheets)	Manual 2-Sided Printing	Borderless Printing
Epson Bright White Ink Jet Paper	A4	40*	✓	–
Epson Ultra Glossy Photo Paper	A4, 13 × 18 cm (5 × 7 in.), 10 × 15 cm (4 × 6 in.)	10	–	✓
Epson Premium Glossy Photo Paper	A4, 13 × 18 cm (5 × 7 in.), 16:9 wide size (102 × 181 mm), 10 × 15 cm (4 × 6 in.)	10	–	✓
Epson Premium Semigloss Photo Paper	A4, 10 × 15 cm (4 × 6 in.)	10	–	✓
Epson Photo Paper Glossy	A4, 13 × 18 cm (5 × 7 in.), 10 × 15 cm (4 × 6 in.)	10	–	✓
Epson Matte Paper-Heavyweight	A4	20	–	✓
Epson Photo Quality Ink Jet Paper	A4	40	–	–

* For manual 2-sided printing, you can load up to 15 sheets for paper with one side already printed.

Note:

The availability of paper varies by location. For the latest information on paper available in your area, contact Epson support.

Commercially Available Paper

Media Name	Size	Loading Capacity (Number of sheets)	Manual 2-Sided Printing	Borderless Printing
Plain paper* ¹	Letter, A4, B5, A5	Up to the line indicated by the triangle symbol on the edge guide.* ²	✓	–
	A6			
	Legal	1		
	User Defined	1	✓	
Envelope	Envelope #10, Envelope DL, Envelope C6	5	–	–

Loading Paper

*1 The loading capacity for pre-punched paper is one sheet.

*2 For manual 2-sided printing, you can load up to 15 sheets for paper with one side already printed.

Related Information

➔ [“Technical Support Web Site” on page 104](#)

List of Paper Types

To obtain optimum printing results, select the paper type that suits the paper.

Media Name	Media Type*2
Epson Bright White Ink Jet Paper*	plain papers
Epson Ultra Glossy Photo Paper*1	Epson Ultra Glossy
Epson Premium Glossy Photo Paper*1	Epson Premium Glossy
Epson Premium Semigloss Photo Paper*1	Epson Premium Semigloss
Epson Photo Paper Glossy*1	Photo Paper Glossy
Epson Matte Paper-Heavyweight*1	Epson Matte
Epson Photo Quality Ink Jet Paper*1	Epson Matte
Plain paper*1	plain papers
Envelope	Envelope

*1 These paper types are compatible with Exif Print and PRINT Image Matching when printed by the printer driver. For more information, see the documentation that came with the Exif Print or PRINT Image Matching compatible digital camera.

*2 For smart devices, these media types can be selected when printing using Epson iPrint.

Loading Paper in the Rear Paper Feed

1. Open the feeder guard, extend the paper support, and then tilt it backwards.

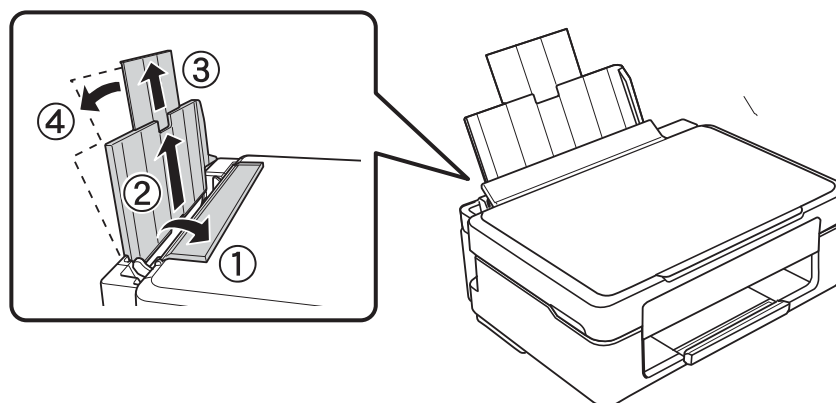

Loading Paper

- Slide the edge guide to the left.

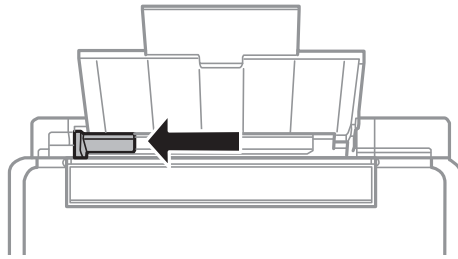

- Load paper vertically along the right side of the rear paper feed with the printable side facing up.

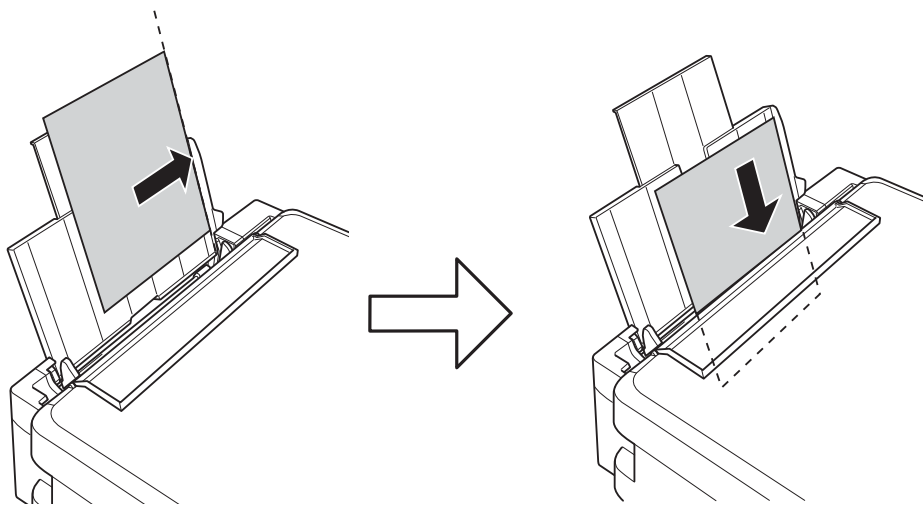

! **Important:**

- Do not load more than the maximum number of sheets specified for the paper. For plain paper, do not load above the line indicated by the triangle symbol on the edge guide.
- When loading paper with a defined size, align it with the paper size indicator on the paper support.

- Envelopes

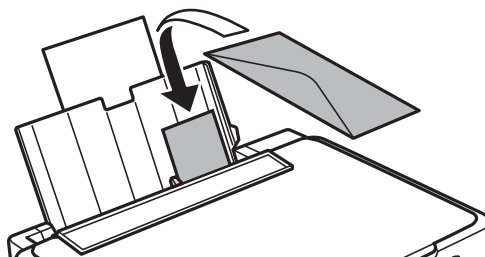

Loading Paper

- ❑ Pre-punched paper

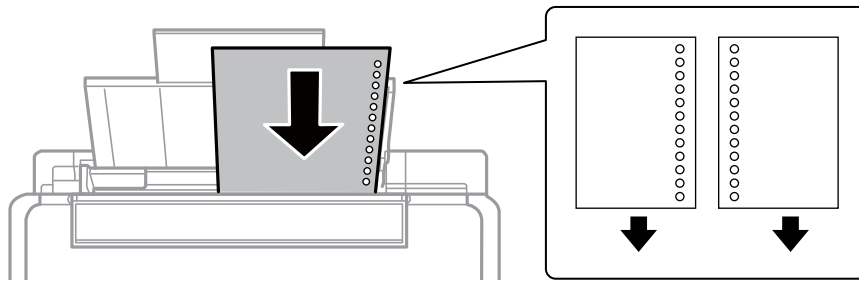

Note:

- ❑ Load a single sheet of paper without binding holes at the top or the bottom.
 - ❑ Adjust the print position of your file to avoid printing over the holes.
4. Slide the edge guide to the edge of the paper, and then close the feeder guard.

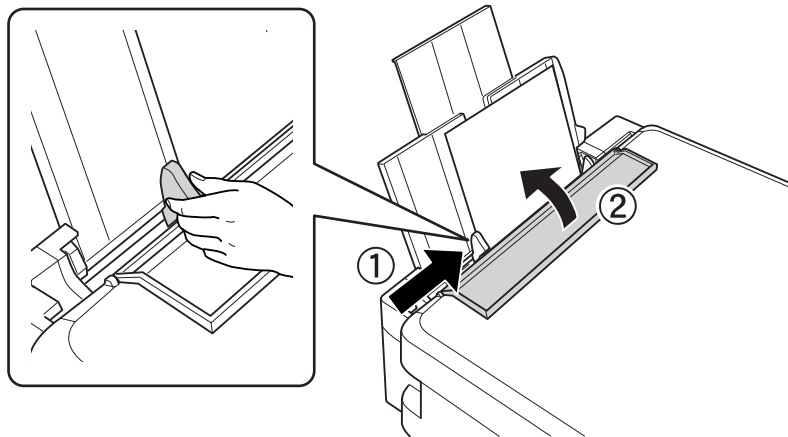

5. Slide out the output tray.

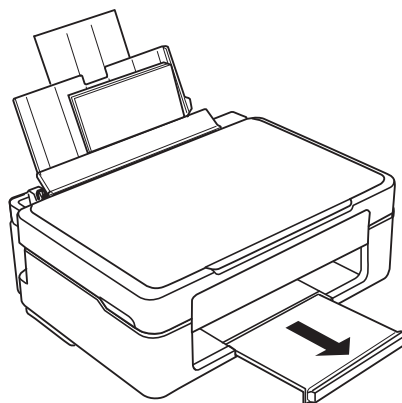

Note:

Return the remaining paper to its package. If you leave it in the printer, the paper may curl or the print quality may decline.

Related Information

➔ [“Paper Handling Precautions” on page 16](#)

Loading Paper

➔ [“Available Paper and Capacities” on page 17](#)

Placing Originals on the Scanner Glass



Important:

When placing bulky originals such as books, prevent exterior light from shining directly onto the scanner glass.

1. Open the document cover.

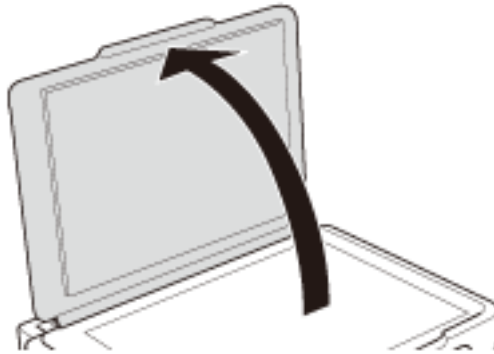

2. Remove any dust or stains on the scanner glass.
3. Place the original face-down and slide it to the corner mark.

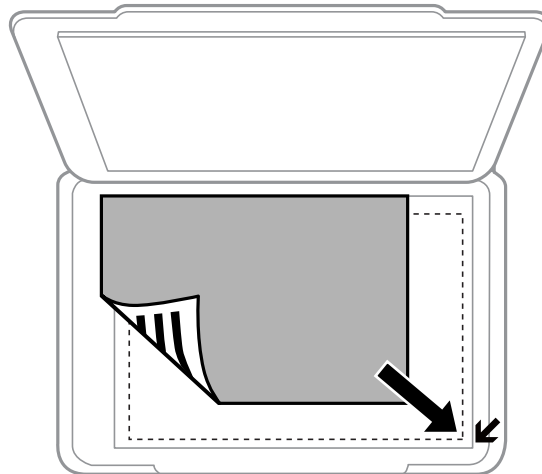

Note:

The area 1.5 mm from the edges of the scanner glass is not scanned.

Placing Originals on the Scanner Glass

If you are scanning using **Full Auto Mode** or a thumbnail preview of EPSON Scan, place the original 4.5 mm away from the horizontal and vertical edges of the scanner glass.

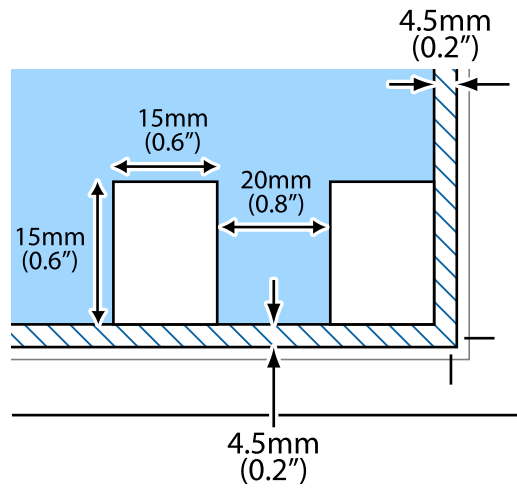

Note:

- ❑ Place multiple photos at least 20 mm apart from each other.
- ❑ The photos should be larger than 15 x 15 mm.

4. Close the cover gently.

Note:

Remove the originals after scanning or copying. If you leave the originals on the scanner glass for a long time, they may stick to the surface of the glass.

Printing

Printing from a Computer

Printing Basics - Windows

Note:

- ❑ See the online help for explanations of the setting items. Right-click an item, and then click **Help**.
- ❑ Operations differ depending on the application. See the application's help for details.

1. Load paper in the printer.
2. Open the file you want to print.
3. Select **Print** or **Print Setup** from the **File** menu.
4. Select your printer.
5. Select **Preferences** or **Properties** to access the printer driver window.

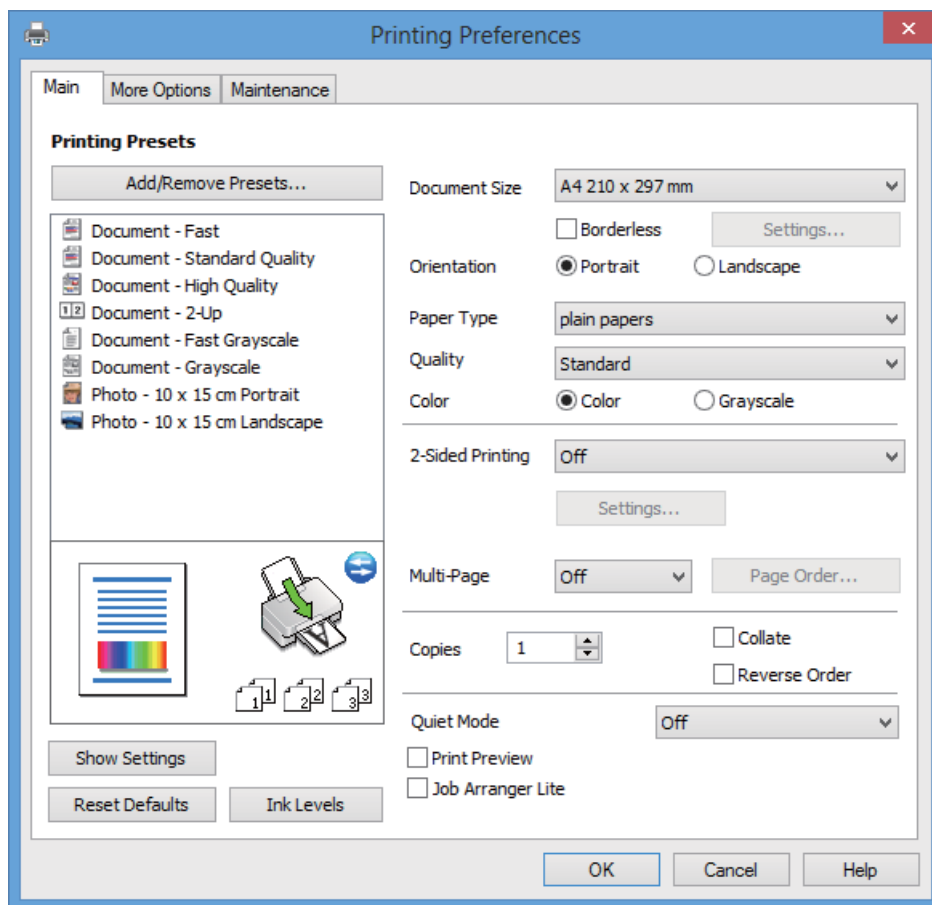

6. Make the following settings.
 - ❑ Document Size: Select the paper size you loaded in the printer.

Printing

- Borderless:** Select to print with no margins around the image.

In borderless printing, the print data is enlarged slightly more than the paper size so that no margins are printed around the edges of the paper. Click **Settings** to select the amount of enlargement.

- Orientation:** Select the orientation you set in the application.
- Paper Type:** Select the type of paper you loaded.
- Color:** Select **Grayscale** when you want to print in black or shades of gray.

Note:

*When printing on envelopes, select **Landscape** as the **Orientation** setting.*

7. Click **OK** to close the printer driver window.

8. Click **Print**.

Related Information

- ➔ [“Available Paper and Capacities” on page 17](#)
- ➔ [“Loading Paper in the Rear Paper Feed” on page 18](#)
- ➔ [“Guide to Windows Printer Driver” on page 70](#)
- ➔ [“List of Paper Types” on page 18](#)

Printing Basics - Mac OS X

Note:

Operations differ depending on the application. See the application's help for details.

1. Load paper in the printer.
2. Open the file you want to print.

Printing

3. Select **Print** from the **File** menu or another command to access the printer driver window.

If necessary, click **Show Details** or ▼ to expand the print window.

The screenshot shows a printer driver window with the following settings:

- Printer: EPSON XXXX
- Presets: Default Settings
- Copies: 1
- Pages: All (selected), From: 1 to: 1
- Paper Size: A4 (210 by 297 mm)
- Orientation: Portrait (selected)
- Preview: (dropdown menu)
- Auto Rotate: (checked)
- Show Notes: (unchecked)
- Scale: 97 %
- Scale to Fit: (checked)
- Print Entire Image: (checked)
- Fill Entire Paper: (unchecked)
- Copies per page: 1

Buttons: Cancel, Print

4. Make the following settings.

- Printer: Select your printer.
- Preset: Select when you want to use the registered settings.
- Paper Size: Select the paper size you loaded in the printer.
When printing with no margins, select a "borderless" paper size.
- Orientation: Select the orientation you set in the application.

Note:

When printing on envelopes, select landscape orientation.

Printing

5. Select **Print Settings** from the pop-up menu.

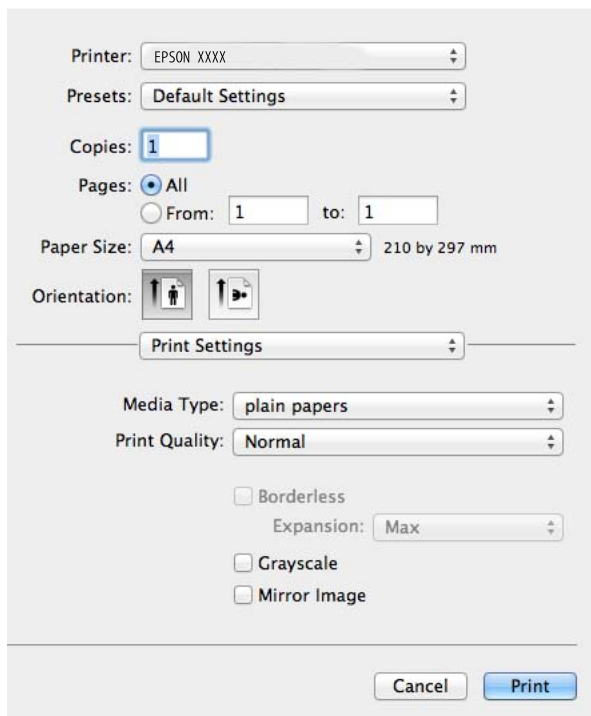

Note:

On Mac OS X v10.8.x or later, if the **Print Settings** menu is not displayed, the Epson printer driver has not been installed correctly.

Select **System Preferences** from the  menu > **Printers & Scanners** (or **Print & Scan**, **Print & Fax**), remove the printer, and then add the printer again. See the following to add a printer.

<http://support.epson.net/setupnavi/>

6. Make the following settings.

- Media Type: Select the type of paper you loaded.
- Expansion: Available when selecting a borderless paper size.

In borderless printing, the print data is enlarged slightly more than the paper size so that no margins are printed around the edges of the paper. Select the amount of enlargement.

- Grayscale: Select to print in black or shades of gray.

7. Click **Print**.

Related Information

- ➔ “Available Paper and Capacities” on page 17
- ➔ “Loading Paper in the Rear Paper Feed” on page 18
- ➔ “Guide to Mac OS X Printer Driver” on page 74
- ➔ “List of Paper Types” on page 18

Printing

Printing on 2-Sides (for Windows only)

The printer driver prints automatically separating even pages and odd pages. When the printer has finished printing the odd pages, flip the paper over following the instructions to print the even pages. You can also print a booklet that can be created by folding the printout.

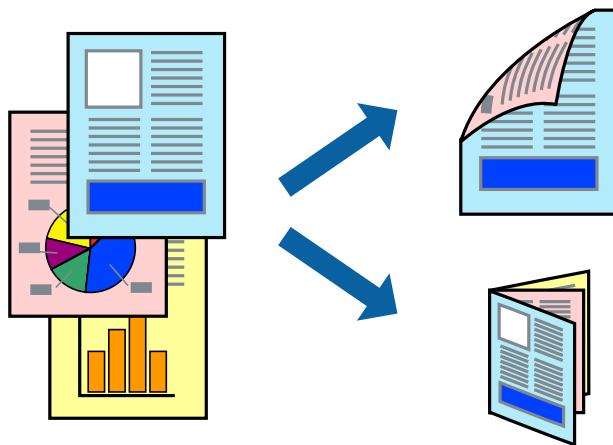

Note:

- This feature is not available for borderless printing.
- If you do not use paper that is suitable for 2-sided printing, the print quality may decline and paper jams may occur.
- Depending on the paper and the data, ink may bleed through to the other side of the paper.
- If **EPSON Status Monitor 3** is disabled, access the printer driver, click **Extended Settings** on the **Maintenance** tab, and then select **Enable EPSON Status Monitor 3**.
- 2-sided printing may not be available when the printer is accessed over a network or is used as a shared printer.

1. Load paper in the printer.
2. Open the file you want to print.
3. Access the printer driver window.
4. Select a binding method from **2-Sided Printing** on the **Main** tab.
5. Click **Settings**, make the appropriate settings, and then click **OK** to close the window.

Note:

To print as a booklet, select **Booklet**.

6. Set the other items on the **Main** and **More Options** tabs as necessary, and then click **OK**.
7. Click **Print**.

When the first side has finished printing, a pop-up window is displayed on the computer. Follow the on-screen instructions.

Related Information

- ➔ [“Available Paper and Capacities” on page 17](#)
- ➔ [“Loading Paper in the Rear Paper Feed” on page 18](#)
- ➔ [“Printing Basics - Windows” on page 24](#)

Printing

Printing Several Pages on One Sheet

You can print two or four pages of data on a single sheet of paper.

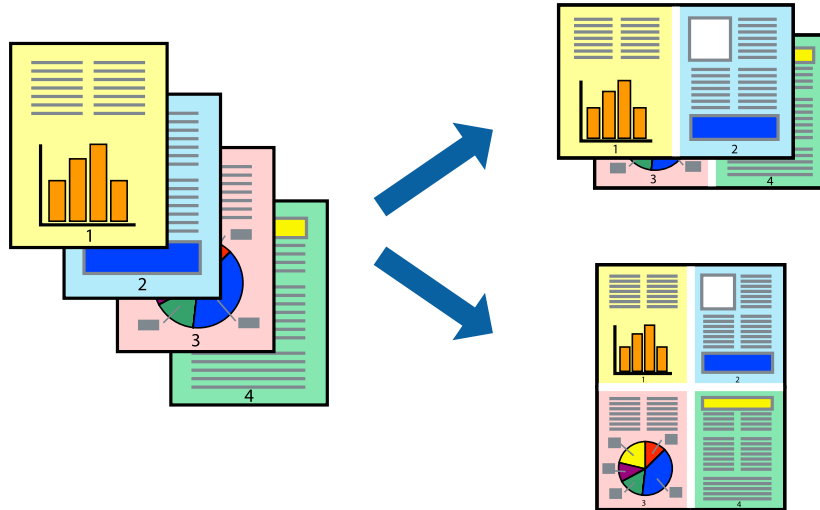

Printing Several Pages on One Sheet - Windows

Note:

This feature is not available for borderless printing.

1. Load paper in the printer.
2. Open the file you want to print.
3. Access the printer driver window.
4. Select **2-Up** or **4-Up** as the **Multi-Page** setting on the **Main** tab.
5. Click **Page Order**, make the appropriate settings, and then click **OK** to close the window.
6. Set the other items on the **Main** and **More Options** tabs as necessary, and then click **OK**.
7. Click **Print**.

Related Information

- ➔ [“Loading Paper in the Rear Paper Feed” on page 18](#)
- ➔ [“Printing Basics - Windows” on page 24](#)

Printing Several Pages on One Sheet - Mac OS X

1. Load paper in the printer.
2. Open the file you want to print.
3. Access the printer driver window.
4. Select **Layout** from the pop-up menu.

Printing

5. Set the number of pages in **Pages per Sheet**, the **Layout Direction** (page order), and **Border**.
6. Set the other items as necessary.
7. Click **Print**.

Related Information

- ➔ [“Loading Paper in the Rear Paper Feed” on page 18](#)
- ➔ [“Printing Basics - Mac OS X” on page 25](#)

Printing to Fit the Paper Size

You can print to fit the paper size you loaded in the printer.



Printing to Fit the Paper Size - Windows

Note:

This feature is not available for borderless printing.

1. Load paper in the printer.
2. Open the file you want to print.
3. Access the printer driver window.
4. Make the following settings on the **More Options** tab.
 - Document Size: Select the paper size you set in the application.
 - Output Paper: Select the paper size you loaded in the printer.
Fit to Page is selected automatically.

Note:

*If you want to print a reduced image at the center of the page, select **Center**.*

5. Set the other items on the **Main** and **More Options** tabs as necessary, and then click **OK**.
6. Click **Print**.

Printing

Related Information

- ➔ [“Loading Paper in the Rear Paper Feed” on page 18](#)
- ➔ [“Printing Basics - Windows” on page 24](#)

Printing to Fit the Paper Size - Mac OS X

1. Load paper in the printer.
2. Open the file you want to print.
3. Access the printer driver window.
4. Select the size of the paper you set in the application as the **Paper Size** setting.
5. Select **Paper Handling** from the pop-up menu.
6. Select **Scale to fit paper size**.
7. Select the paper size you loaded in the printer as the **Destination Paper Size** setting.
8. Set the other items as necessary.
9. Click **Print**.

Related Information

- ➔ [“Loading Paper in the Rear Paper Feed” on page 18](#)
- ➔ [“Printing Basics - Mac OS X” on page 25](#)

Printing Multiple Files Together (for Windows Only)

Job Arranger Lite allows you to combine several files created by different applications and print them as a single print job. You can specify the print settings for combined files, such as layout, print order, and orientation.

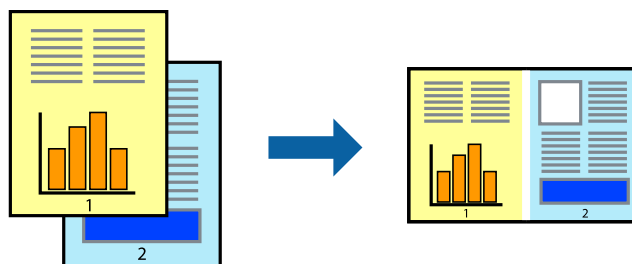

Note:

To open a **Print Project** saved in **Job Arranger Lite**, click **Job Arranger Lite** on the printer driver's **Maintenance** tab. Next, select **Open** from the **File** menu to select the file. The extension of the saved files is ".ecl".

1. Load paper in the printer.
2. Open the file you want to print.
3. Access the printer driver window.

Printing

4. Select **Job Arranger Lite** on the **Main** tab.
5. Click **OK** to close the printer driver window.
6. Click **Print**.

The **Job Arranger Lite** window is displayed and the print job is added to the **Print Project**.

7. With the **Job Arranger Lite** window opened, open the file that you want to combine with the current file, and then repeat steps 3 to 6.

Note:

*If you close the **Job Arranger Lite** window, the unsaved **Print Project** is deleted. To print later, select **Save** from the **File** menu.*

8. Select the **Layout** and **Edit** menus in **Job Arranger Lite** to edit the **Print Project** as necessary.
9. Select **Print** from the **File** menu.

Related Information

- ➔ [“Loading Paper in the Rear Paper Feed” on page 18](#)
- ➔ [“Printing Basics - Windows” on page 24](#)

Enlarged Printing and Making Posters (for Windows Only)

You can print one image on multiple sheets of paper to create a larger poster. You can print alignment marks that help you stick the sheets together.

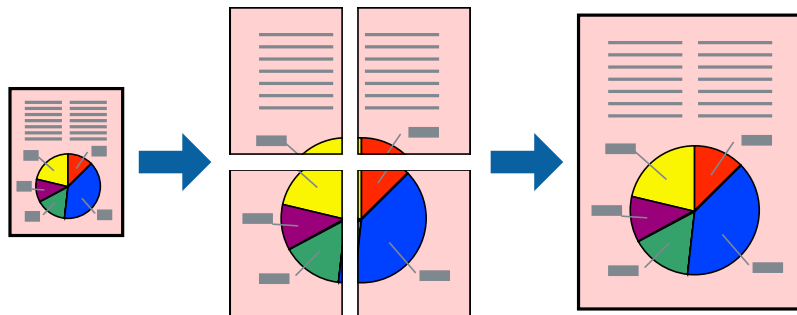

Note:

This feature is not available for borderless printing.

1. Load paper in the printer.
2. Open the file you want to print.
3. Access the printer driver window.
4. Select **2x1 Poster**, **2x2 Poster**, **3x3 Poster**, or **4x4 Poster** from **Multi-Page** on the **Main** tab.
5. Click **Settings**, make the appropriate settings, and then click **OK**.
6. Set the other items on the **Main** and **More Options** tabs as necessary, and then click **OK**.

Printing

7. Click **Print**.

Related Information

- ➔ [“Loading Paper in the Rear Paper Feed”](#) on page 18
- ➔ [“Printing Basics - Windows”](#) on page 24

Making Posters Using Overlapping Alignment Marks

Here is an example of how to make a poster when **2x2 Poster** is selected, and **Overlapping Alignment Marks** is selected in **Print Cutting Guides**.

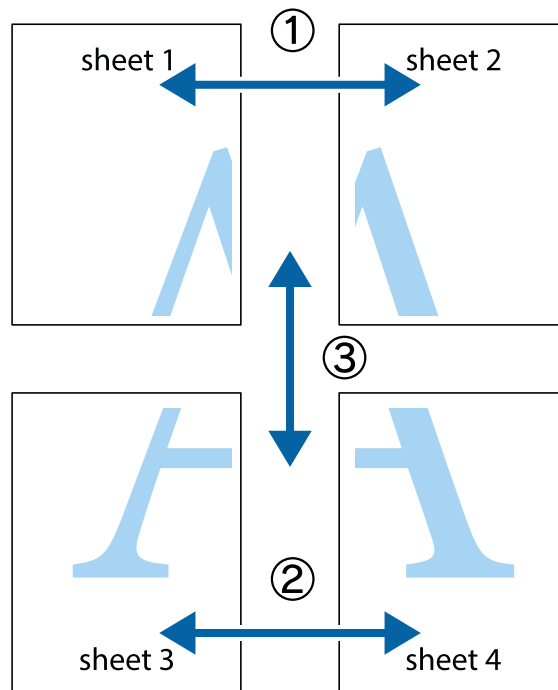

Printing

1. Prepare Sheet 1 and Sheet 2. Cut off the margins of Sheet 1 along the vertical blue line through the center of the top and bottom cross marks.

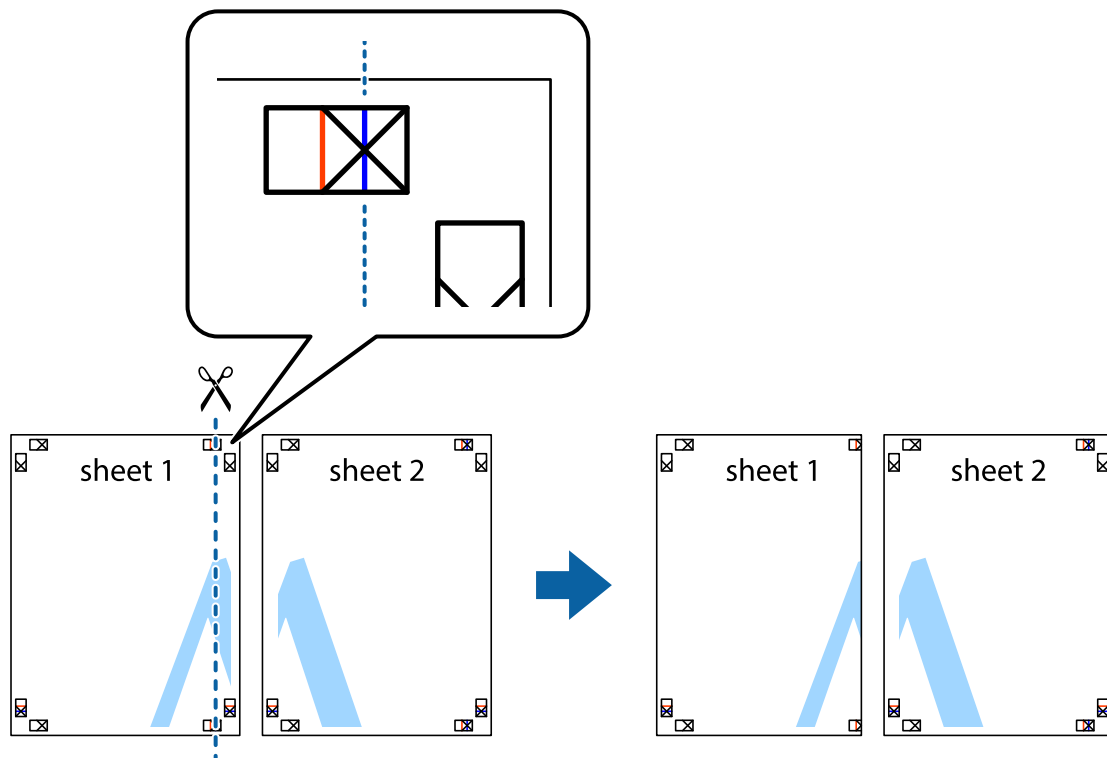

2. Place the edge of Sheet 1 on top of Sheet 2 and align the cross marks, then temporarily tape the two sheets together from the back.

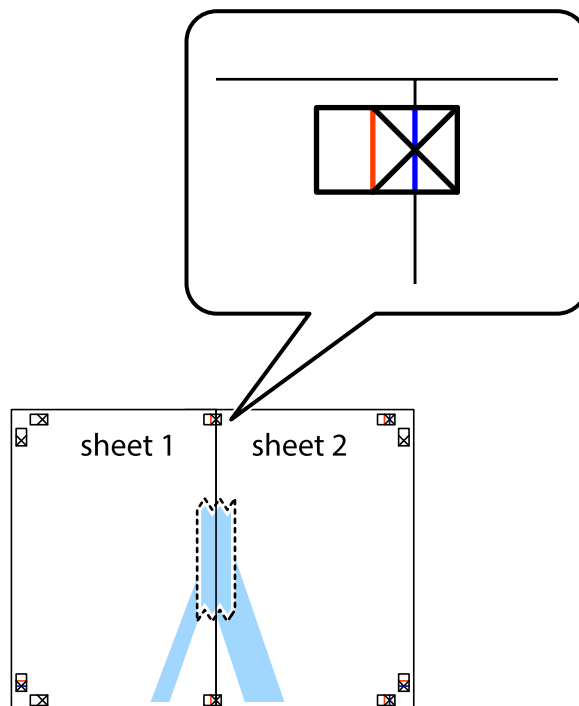

Printing

3. Cut the taped sheets in two along the vertical red line through the alignment markers (this time, the line to the left of the cross marks).

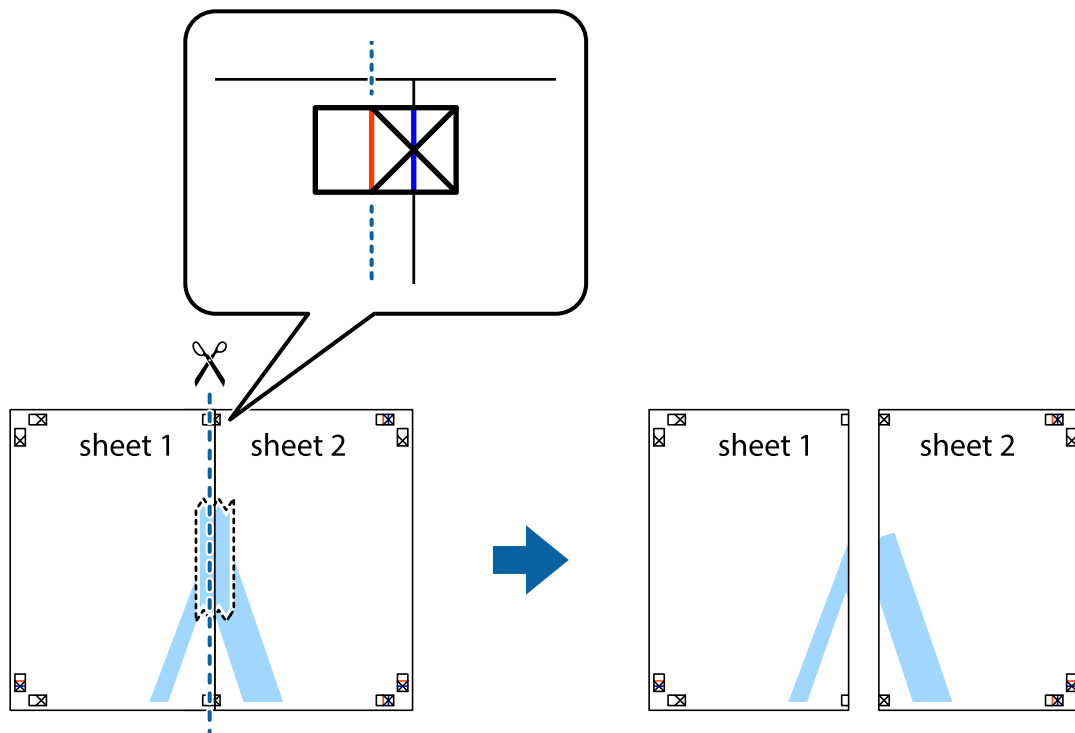

4. Tape the sheets together from the back.

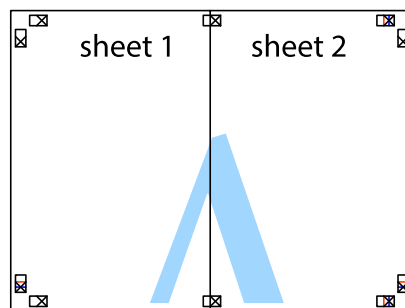

5. Repeat steps 1 to 4 to tape Sheet 3 and Sheet 4 together.

Printing

6. Cut off the margins of Sheet 1 and Sheet 2 along the horizontal blue line through the center of the left and right side cross marks.

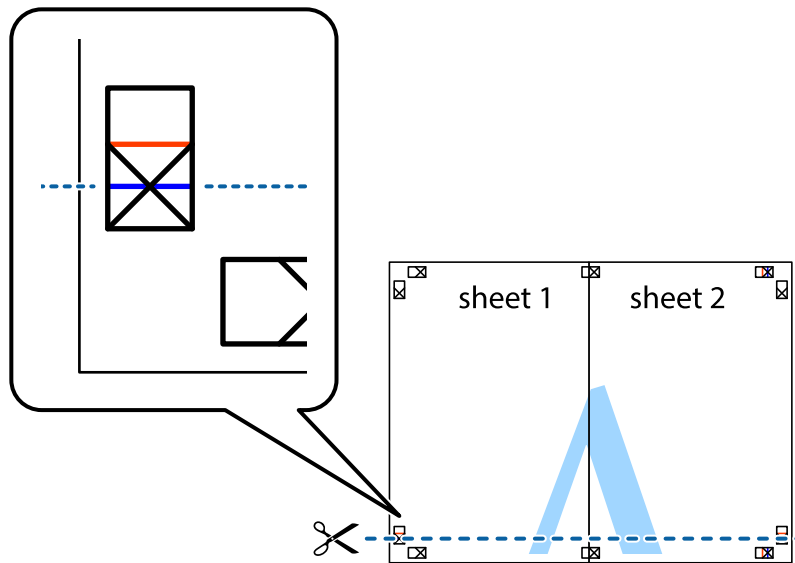

7. Place the edge of Sheet 1 and Sheet 2 on top of Sheet 3 and Sheet 4 and align the cross marks, and then temporarily tape them together from the back.

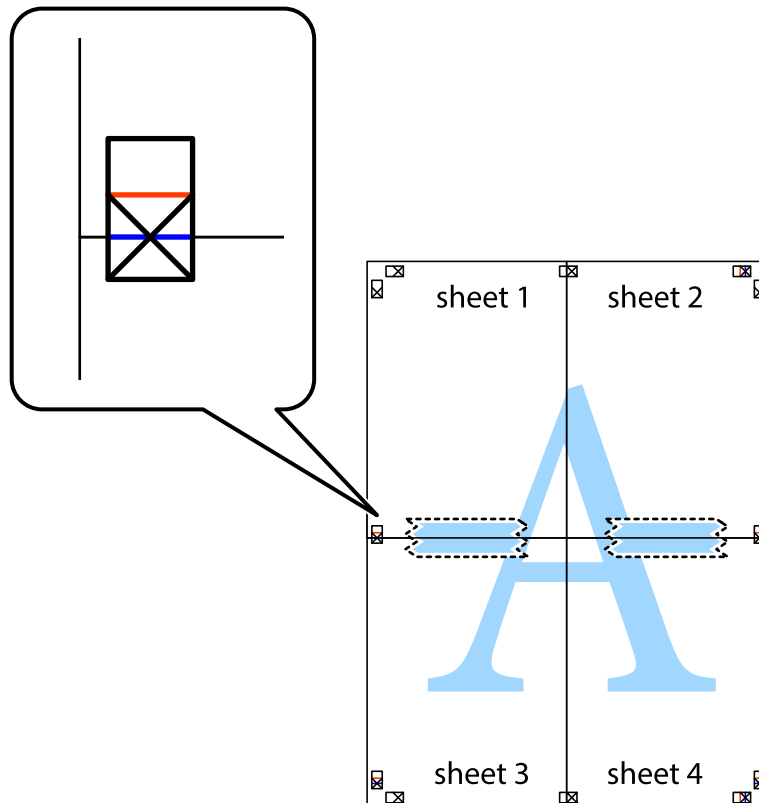

Printing

- Cut the taped sheets in two along the horizontal red line through the alignment markers (this time, the line above the cross marks).

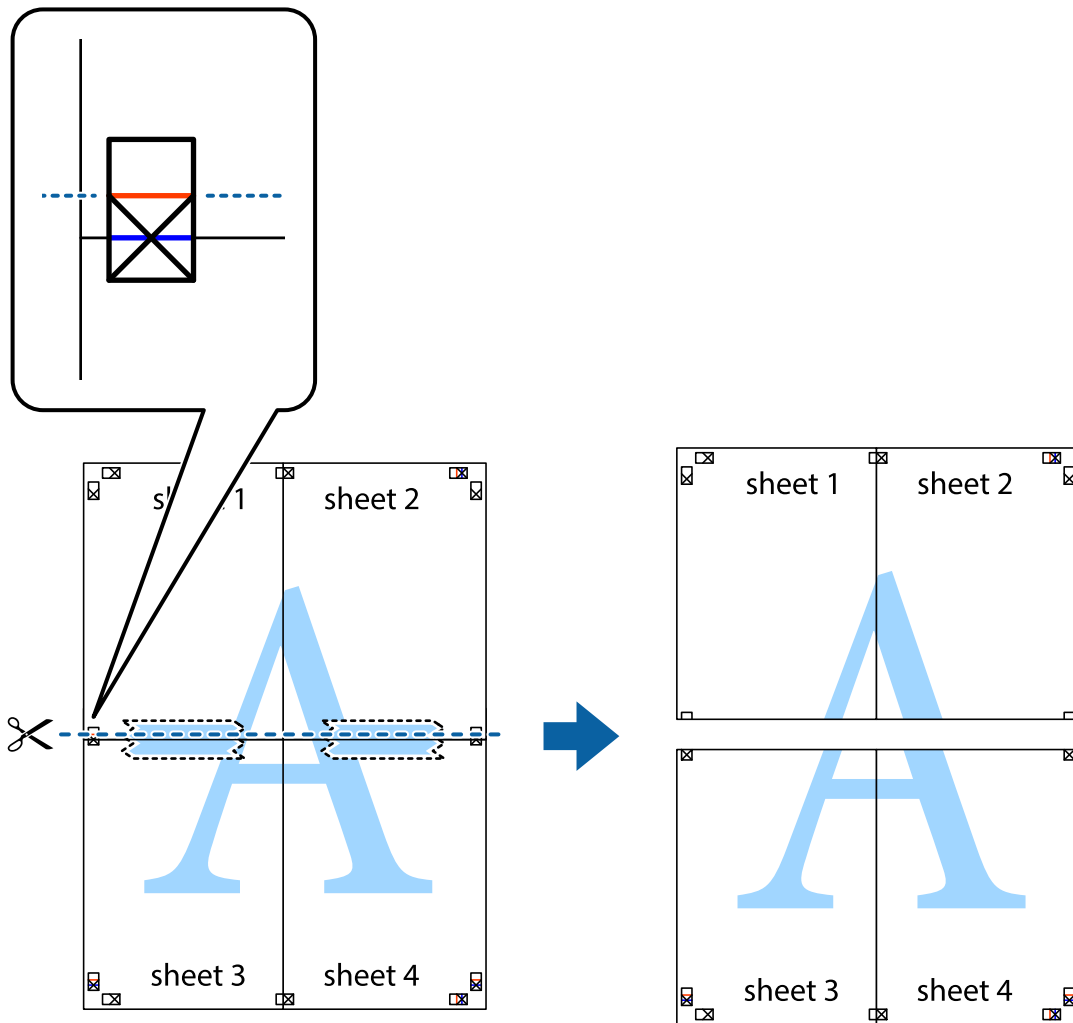

- Tape the sheets together from the back.

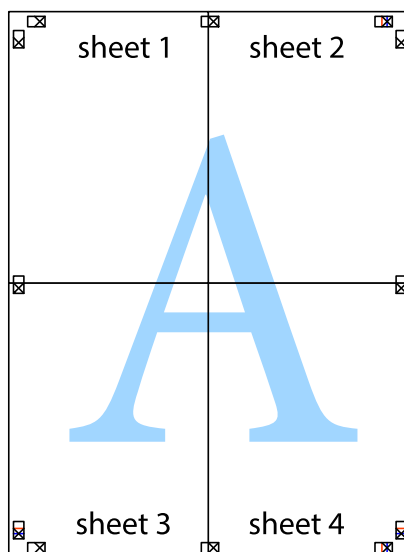

Printing

10. Cut off the remaining margins along the outer guide.

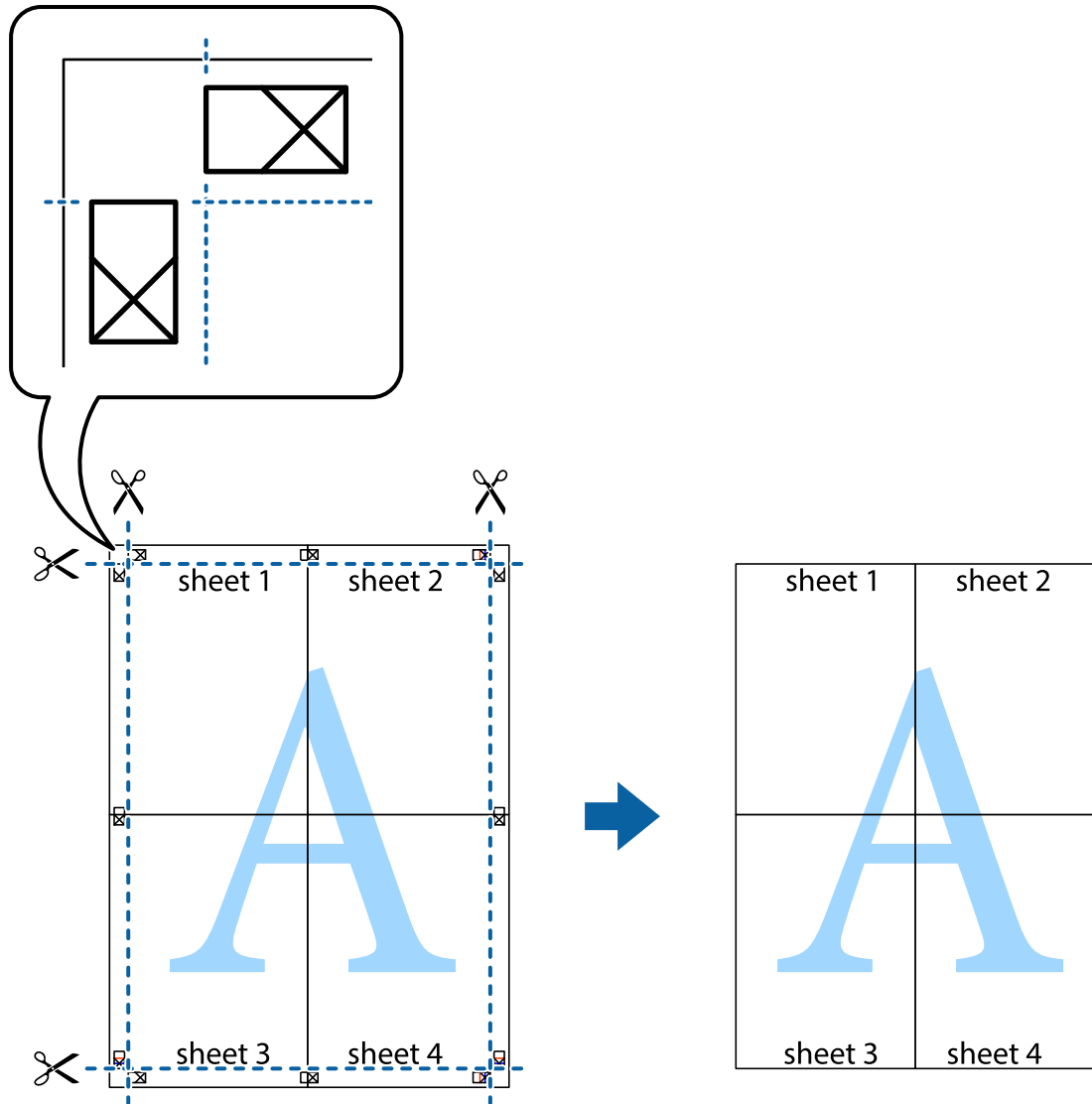

Printing Using Advanced Features

This section introduces a variety of additional layout and printing features available on the printer driver.

Related Information

- ➔ [“Windows Printer Driver” on page 69](#)
- ➔ [“Mac OS X Printer Driver” on page 73](#)

Adding a Printing Preset to Print Easily

If you create your own preset of frequently used print settings on the printer driver, you can print easily by selecting the preset from the list.

Printing

Windows

To add your own preset, set items such as the **Document Size** and **Paper Type** on the **Main** or **More Options** tab, and then click **Add/Remove Presets** in **Printing Presets**.

Note:

To delete an added preset, click **Add/Remove Presets**, select the preset name you want to delete from the list, and then delete it.

Mac OS X

Access the printer driver window. To add your own preset, set items such as the **Paper Size** and **Media Type**, and then save the current settings as the preset in the **Presets** setting.

Note:

To delete an added preset, click **presets > Show Presets**, select the preset name you want to delete from the list, and then delete it.

Printing a Reduced or Enlarged Document

You can reduce or enlarge the size of a document by a specific percentage.

Windows

Note:

This feature is not available for borderless printing.

Set the **Document Size** on the **More Options** tab. Select **Reduce/Enlarge Document**, **Zoom to**, and then enter a percentage.

Mac OS X

Access the printer driver window. Select **Scale**, and then enter a percentage.

Adjusting the Print Color

You can adjust the colors used in the print job.

PhotoEnhance produces sharper images and more vivid colors by automatically adjusting the contrast, saturation, and brightness of the original image data.

Note:

- These adjustments are not applied to the original data.
- PhotoEnhance** adjusts the color by analyzing the location of the subject. Therefore, if you have changed the location of the subject by reducing, enlarging, cropping, or rotating the image, the color may change unexpectedly. Selecting the borderless setting also changes the location of the subject resulting in changes in color. If the image is out of focus, the tone may be unnatural. If the color is changed or becomes unnatural, print in a mode other than **PhotoEnhance**.

Windows

Select the method of color correction from **Color Correction** on the **More Options** tab.

If you select **Automatic**, the colors are automatically adjusted to match the paper type and print quality settings. If you select **Custom** and click **Advanced**, you can make your own settings.

Printing

Mac OS X

Access the printer driver window. Select **Color Matching** from the pop-up menu, and then select **EPSON Color Controls**. Select **Color Options** from the pop-up menu, and then select one of the available options. Click the arrow next to **Advanced Settings** and make the appropriate settings.

Printing a Watermark (for Windows Only)

You can print a watermark such as "Confidential" on your printouts. You can also add your own watermark.

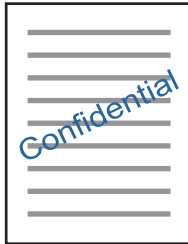

Note:

This feature is not available for borderless printing.

Click **Watermark Features** on the **More Options** tab, and then select a watermark. Click **Settings** to change details such as the color and position of the watermark.

Printing a Header and Footer (for Windows Only)

You can print information such as a user name and printing date as headers or footers.

Click **Watermark Features** in the **More Options** tab, and then select **Header/Footer**. Click **Settings** and select necessary items from the drop-down list.

Printing Photos Using Epson Easy Photo Printt

Epson Easy Photo Printt lets you lay out and print photos easily on various types of paper.

Note:

- By printing on genuine Epson photo paper, the ink quality is maximized and the printouts are vivid and clear.*
- To perform borderless printing using a commercially available application, make the following settings.*
 - Create the image data to fully fit the paper size and if a margin setting is available in the application you are using, set the margin to 0 mm.*
 - Enable the borderless printing setting in the printer driver.*

Related Information

- ➔ [“Available Paper and Capacities” on page 17](#)
- ➔ [“Loading Paper in the Rear Paper Feed” on page 18](#)
- ➔ [“Epson Easy Photo Print” on page 77](#)

Printing from Smart Devices

Using Epson iPrint

Epson iPrint is an application that allows you to print photos, documents, and Web pages from a smart device such as a smartphone or tablet. You can use either local print, printing from a smart device that is connected to the same wireless network as your printer, or remote print, printing from a remote location over the Internet. To use remote print, register your printer in the Epson Connect service.



You can install Epson iPrint on your smart device from the following URL or QR code.

<http://ipr.to/a>



Using Epson iPrint

Start Epson iPrint from your smart device and select the item you want to use from the home screen.

The following screens are subject to change without notice.

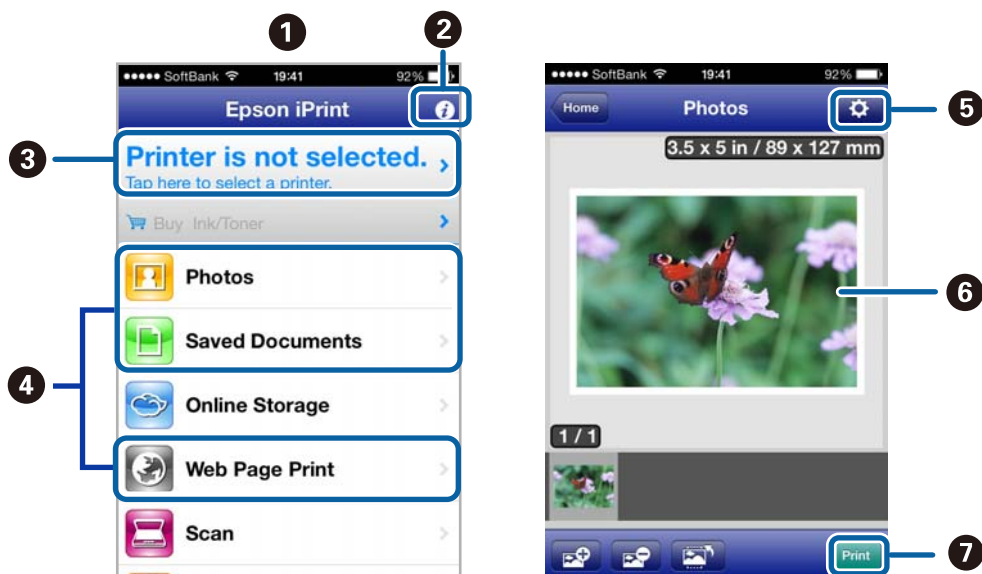

1	Home screen displayed when the application is started.
---	--

Printing

2	Displays information on how to setup the printer and a FAQ.
3	Displays the screen where you can select the printer and make printer settings. Once you have selected the printer, you do not need to select it again from the next time.
4	Select what you want to print such as photos, documents, and web pages.
5	Displays the screen to make print settings such as paper size and paper type.
6	Displays photos and documents you selected.
7	Starts printing.

Note:

To print from the document menu using iPhone, iPad, and iPod touch running iOS, start Epson iPrint after transferring the document you want to print using the file sharing function in iTunes.

Related Information

➔ [“Epson Connect Service” on page 68](#)

Canceling Printing

Note:

- In Windows, you cannot cancel a print job from the computer once it has been completely sent to the printer. In this case, cancel the print job by using the printer's control panel.
- When printing several pages from Mac OS X, you cannot cancel all of the jobs by using the control panel. In this case, cancel the print job from the computer.
- If you have sent a print job from Mac OS X v10.6.x through the network, you may not be able to cancel printing from the computer. In this case, cancel the print job by using the printer's control panel. You need to change settings in Web Config to cancel printing from the computer. See the Network Guide for more details.

Canceling Printing - Printer Button

Press the  button to cancel the print job in progress.

Canceling Printing - Windows

1. Access the printer driver window.
2. Select the **Maintenance** tab.
3. Click **Print Queue**.
4. Right-click on the job you want to cancel and then select **Cancel**.

Related Information

➔ [“Windows Printer Driver” on page 69](#)

Canceling Printing - Mac OS X

1. Click the printer icon in the **Dock**.
2. Select the job you want to cancel.
3. Cancel the job.
 - Mac OS X v10.8.x to Mac OS X v10.9.x
Click  next to the progress meter.
 - Mac OS X v10.6.x to v10.7.x
Click **Delete**.

Copying



Copying Basics

You can copy on A4-size plain paper at the same magnification. Margins with a width of 3 mm appear around the edges of the paper regardless of whether or not the original has margins around the edges of the paper. When copying originals smaller than A4-size, margins will be wider than 3 mm depending on the position where you place the original.

1. Load A4-size plain paper in the printer.
2. Place the originals.

3. Press the  or  button.

Note:

Hold down the  or  button for three seconds to copy in draft mode, where you can use less ink and print at a lower density. For users in Belgium, the draft mode is not available.

Related Information

- ➔ [“Loading Paper in the Rear Paper Feed” on page 18](#)
- ➔ [“Placing Originals on the Scanner Glass” on page 22](#)



Making 20 Copies

You can make 20 copies at a time. Margins with a width of 3 mm appear around the edges of the paper.

1. Load the same number of sheets of A4-size plain paper that you want to copy in the printer.
2. Place the originals.

3. Press the  or  button while holding down the  button.

Note:

- ❑ If you load less than 20 sheets of paper, an error occurs when the paper runs out and copying stops. To continue copying, load more paper and then press the  or  button. To finish copying, press the  button.
- ❑ To make 21 copies or more, repeat step 3.

Related Information

- ➔ [“Loading Paper in the Rear Paper Feed” on page 18](#)
- ➔ [“Placing Originals on the Scanner Glass” on page 22](#)



Scanning

Scanning from the Control Panel

You can save the scanned image in PDF format to a computer which is connected to the printer with a USB cable.

**Important:**

Make sure you have installed EPSON Scan and Epson Event Manager on your computer before using this feature.

1. Place the originals.
2. Press the  button and the  button simultaneously.

Note:

You can change to frequently-used scan settings such as the document type, folder to save, or save format by using Epson Event Manager.

Related Information

➔ [“Placing Originals on the Scanner Glass” on page 22](#)

Scanning from a Computer

Scan using the scanner driver "EPSON Scan". See the EPSON Scan help for an explanation of each setting item.

Scanning Basics

This section uses EPSON Scan's **Home Mode** to explain the basics of scanning. The operation work flow is the same in other scanning modes.

1. Place the originals.
2. Start EPSON Scan.

Scanning

3. Select **Home Mode** from the **Mode** list.

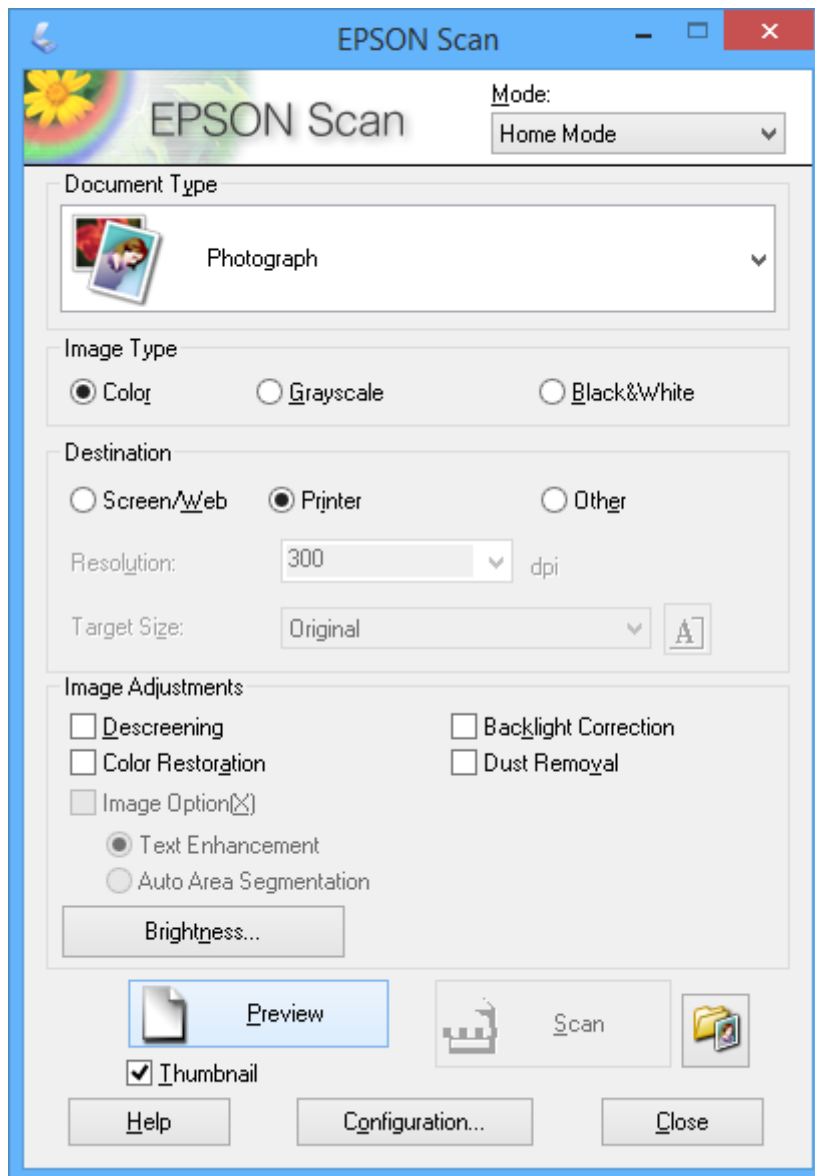

4. Make the following settings.

- Document Type: Select the type of the original you want to scan.
- Image Type: Select the color type of the image you want to scan.
Although this is automatically selected by the **Document Type** setting, you can change the setting.
- Destination: Select the resolution of the image you want to scan.
If you select **Other**, you can set **Resolution** and **Target Size** (output image size).
- Thumbnail: Only available if you select **Photograph** as the **Document Type** setting.
If you select this item and click **Preview**, you can scan by automatically detecting the scan area, direction, or skew of the document, or place multiple photos on the scanner glass.

Scanning

5. Click **Preview**.

Note:

- ❑ *Depending on the photos and the scanning conditions, the scan results may not be as intended. Clear **Thumbnail**, and only place one photo.*
- ❑ *When placing multiple photos, place them at least 20 mm (0.8 inch) apart. Also, the edge area of the scanner glass is not scanned.*

6. Adjust the quality or brightness of the image as necessary.

Note:

Depending on the originals, the scan results may not be as intended.

7. Click **Scan**.

8. In the **File Save Settings** window, make appropriate settings and then click **OK**.

Note:

*When **Show this dialog box before next scan** is cleared, the **File Save Settings** screen is not displayed and scanning starts immediately. To display the **File Save Settings** screen, click the icon (**File Save Settings**) to the right of **Scan** before starting to scan.*

Related Information

- ➔ [“Placing Originals on the Scanner Glass” on page 22](#)
- ➔ [“EPSON Scan \(Scanner Driver\)” on page 76](#)

Scanning

Scanning Using Advanced Features

Scanning by Detecting the Original Automatically (Full Auto Mode)

You can start scanning by simply placing the original and clicking **Scan**. Select **Full Auto Mode** from the **Mode** list in EPSON Scan.

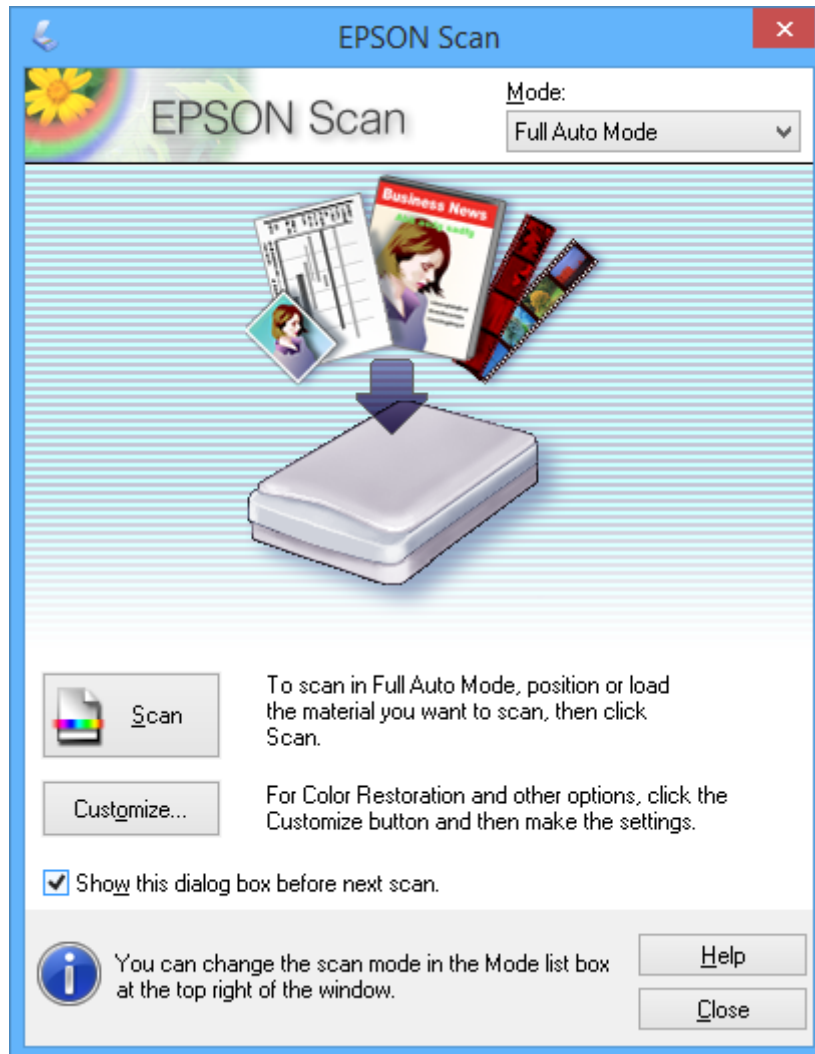

Scanning

Scanning at Specified Sizes (Office Mode)

You can scan originals at the specified size without previewing the image. Select **Office Mode** from the **Mode** list in EPSON Scan.

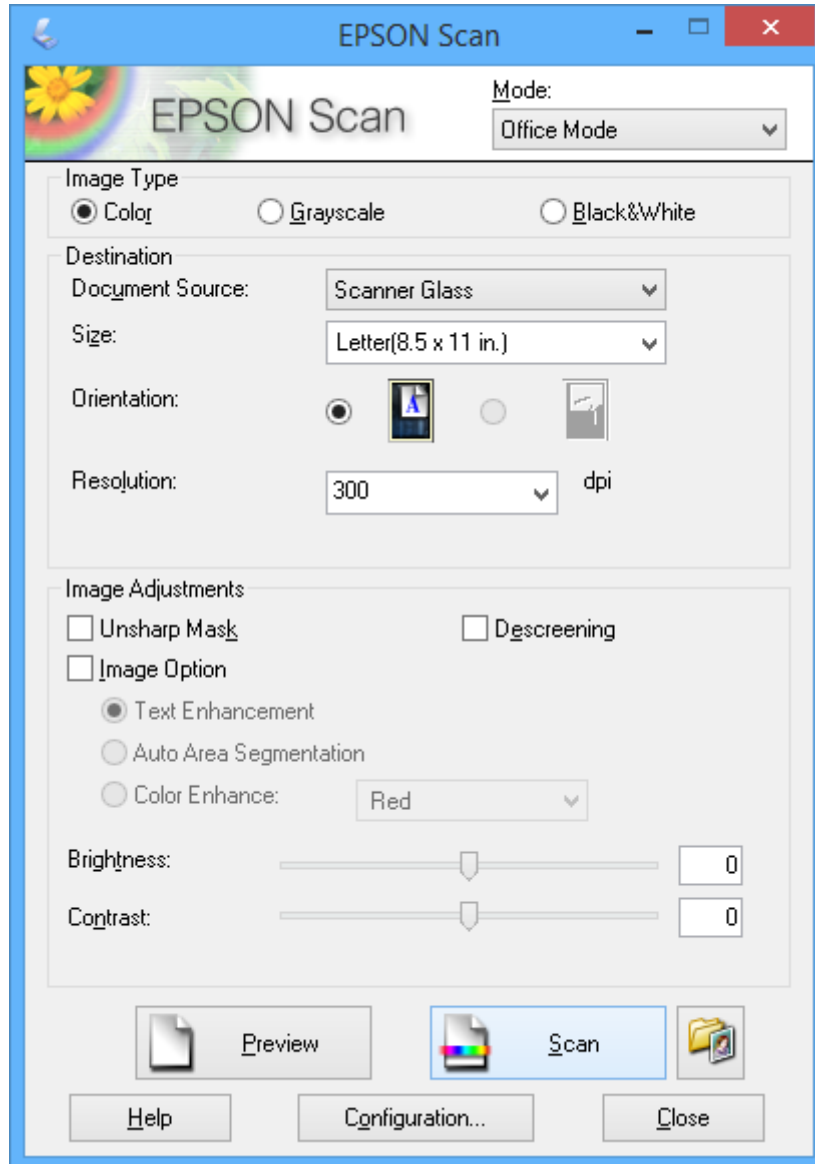

Scanning

Scanning by Adjusting the Image Quality (Professional Mode)

You can scan images while adjusting the quality and color. This mode is recommended for advanced users. Select **Professional Mode** from the **Mode** list in EPSON Scan.

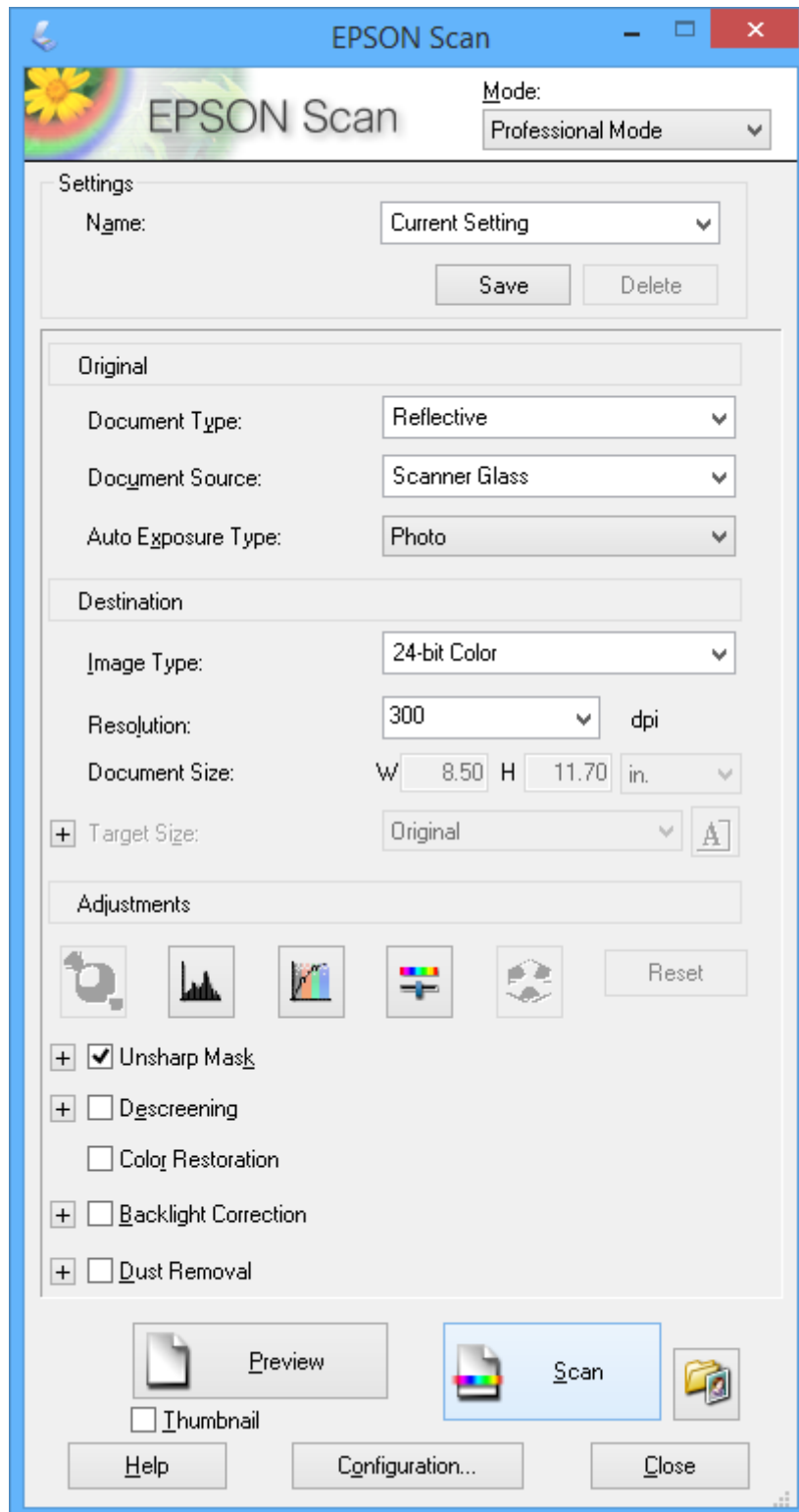

Scanning from Smart Devices

Epson iPrint is an application that allows you to scan photos and documents from a smart device, such as a smartphone or tablet, that is connected to the same wireless network as your printer. You can save the scanned data on a smart device or to Cloud services, send it by email, or print it.

You can install Epson iPrint on your smart device from the following URL or QR code.

<http://ipr.to/a>



Using Epson iPrint

Start Epson iPrint from your smart device and select the item you want to use from the home screen.

The following screens are subject to change without notice.

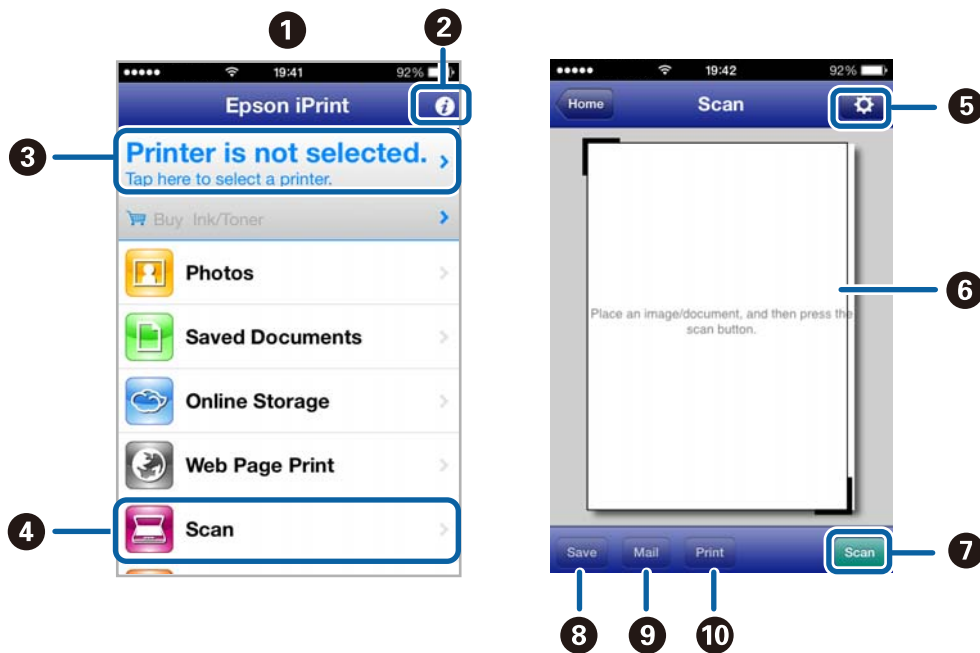

1	Home screen displayed when the application is started.
2	Displays information on how to setup the printer and a FAQ.
3	Displays the screen where you can select the printer and make printer settings. Once you have selected the printer, you do not need to select it again from the next time.
4	Displays the scanning screen.
5	Displays the screen where you can make scan settings such as resolution.
6	Displays scanned images.
7	Starts scanning.

Scanning

8	Displays the screen where you can save scanned data to a smart device or Cloud services.
9	Displays the screen where you can send scanned data by email.
10	Displays the screen where you can print scanned data.

Related Information

- ➔ [“Using Epson iPrint” on page 41](#)
- ➔ [“Epson Connect Service” on page 68](#)

Replacing Ink Cartridges

Checking the Ink Levels

You can check the approximate ink levels from the computer.

Checking the Ink Levels - Windows

1. Access the printer driver window.
2. Click **EPSON Status Monitor 3** on the **Maintenance** tab.

Note:

*If EPSON Status Monitor 3 is disabled, click **Extended Settings** on the **Maintenance** tab, and then select **Enable EPSON Status Monitor 3**.*

Related Information

➔ [“Windows Printer Driver” on page 69](#)

Checking the Ink Levels - Mac OS X

1. Select **System Preferences** from the  menu > **Printers & Scanners** (or **Print & Scan, Print & Fax**), and then select the printer.
2. Click **Options & Supplies** > **Utility** > **Open Printer Utility**.
3. Click **EPSON Status Monitor**.

Ink Cartridge Codes

Epson recommends the use of genuine Epson ink cartridges. Epson cannot guarantee the quality or reliability of non-genuine ink. The use of non-genuine ink may cause damage that is not covered by Epson's warranties, and under certain circumstances, may cause erratic printer behavior. Information about non-genuine ink levels may not be displayed.

The following are the codes for genuine Epson ink cartridges.

Product	Icon	BK (Black)	C (Cyan)	M (Magenta)	Y (Yellow)
XP-225	Daisy 	18 18XL*	18 18XL*	18 18XL*	18 18XL*

* "XL" indicates a large cartridge.

Singapore, Hong Kong, Taiwan, and Korea

Replacing Ink Cartridges

Product	BK (Black)	C (Cyan)	M (Magenta)	Y (Yellow)
XP-225	176 177*	176 177*	176 177*	176 177*

* "177" indicates a large cartridge.

Note:

- Not all cartridges are available in all regions.
- For information on Epson's ink cartridge yields, visit the following website.
<http://www.epson.eu/pageyield>

Ink Cartridge Handling Precautions

Read the following instructions before replacing ink cartridges.

Handling precautions

- Store ink cartridges at normal room temperature and keep them away from direct sunlight.
- Epson recommends using the ink cartridge before the date printed on the package.
- For best results, use up ink cartridge within six months of opening the package.
- For best results, store ink cartridge packages with their bottom down.
- After bringing an ink cartridge inside from a cold storage site, allow it to warm up at room temperature for at least three hours before using it.
- Do not open the ink cartridge package until you are ready to install it in the printer. The cartridge is vacuum packed to maintain its reliability. If you leave a cartridge unpacked for a long time before using it, normal printing may not be possible.
- Be careful not to break the hooks on the side of the ink cartridge when you remove it from the package.
- You must remove the yellow tape from the cartridge before installing it; otherwise, print quality may decline or you may not be able to print. Do not remove or tear the label on the cartridge; this can cause leakage.



Replacing Ink Cartridges

- ❑ Do not remove the transparent seal from the bottom of the cartridge; otherwise, the cartridge may become unusable.



- ❑ Do not touch the sections shown in the illustration. Doing so may prevent normal operation and printing.



- ❑ Install all ink cartridges; otherwise you cannot print.
- ❑ Do not replace ink cartridges with the power off. Do not move the print head by hand; otherwise, you may damage the printer.
- ❑ After installing the ink cartridge, the power light continues to flash while the printer is charging ink. Do not turn off the printer during ink charging. If the ink charging is incomplete, you may not be able to print.
- ❑ Do not leave the printer with the ink cartridges removed or do not turn off the printer during cartridge replacement. Otherwise, ink remaining in the print head nozzles will dry out and you may not be able to print.
- ❑ If you need to remove an ink cartridge temporarily, make sure you protect the ink supply area from dirt and dust. Store the ink cartridge in the same environment as the printer, with the ink supply port facing down or sideways. Do not store ink cartridges with the ink supply port facing up. Because the ink supply port is equipped with a valve designed to contain the release of excess ink, there is no need to supply your own covers or plugs.
- ❑ Removed ink cartridges may have ink around the ink supply port, so be careful not to get any ink on the surrounding area when removing the cartridges.
- ❑ This printer uses ink cartridges equipped with a green chip that monitors information such as the amount of remaining ink for each cartridge. This means that even if the cartridge is removed from the printer before it is expended, you can still use the cartridge after reinserting it back into the printer. However, when reinserting a cartridge, some ink may be consumed to guarantee printer performance.
- ❑ For maximum ink efficiency, only remove an ink cartridge when you are ready to replace it. Ink cartridges with low ink status may not be used when reinserted.

Replacing Ink Cartridges

- ❑ To ensure you receive premium print quality and to help protect your print head, a variable ink safety reserve remains in the cartridge when your printer indicates to replace the cartridge. The yields quoted for you do not include this reserve.
- ❑ Although the ink cartridges may contain recycled materials, this does not affect printer function or performance.
- ❑ Specifications and appearance of the ink cartridge are subject to change without prior notice for improvement.
- ❑ Do not disassemble or remodel the ink cartridge, otherwise you may not be able to print normally.
- ❑ You cannot use the cartridges that came with the printer for the replacement.
- ❑ Quoted yields may vary depending on the images that you are printing, the paper type that you are using, the frequency of your prints and environmental conditions such as temperature.

Ink consumption

- ❑ To maintain optimum print head performance, some ink is consumed from all cartridges not only during printing but also during maintenance operations such as ink cartridge replacement and print head cleaning.
- ❑ When printing in monochrome or grayscale, color inks instead of black ink may be used depending on the paper type or print quality settings. This is because a mixture of color inks is used to create black.
- ❑ The ink in the ink cartridges supplied with your printer is partly used during initial setup. In order to produce high quality printouts, the print head in your printer will be fully charged with ink. This one-off process consumes a quantity of ink and therefore these cartridges may print fewer pages compared to subsequent ink cartridges.

Replacing Ink Cartridges

Note:

If you replace the ink cartridges while copying, the originals may move out of place. Press the ⏏ button to cancel and replace the originals.

1. Open the scanner unit with the document cover closed.

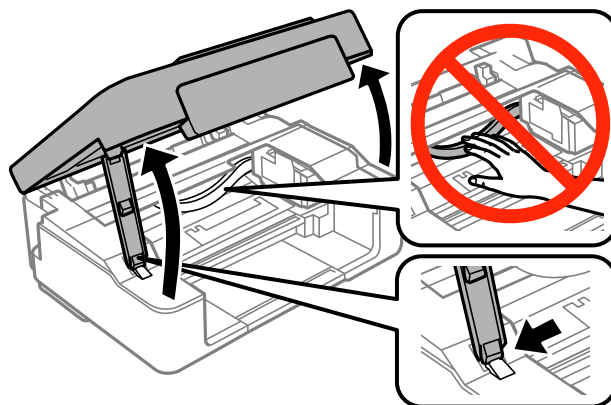





2. Operate the printer's buttons to move the print head.

- ❑ If the 💧 light is on

Press the ⏏ button. The expended ink cartridge moves to the 🗑️ icon. If there are more expended ink cartridges, the cartridge moves to the 🗑️ icon every time you press the ⏏ button.

Replacing Ink Cartridges

- ❑ If the  light flashes

Press the  button for six seconds until the print head moves. The ink cartridge that is running low moves to the  icon. If there are more ink cartridges running low, the cartridge moves to the  icon every time you press the  button.

- ❑ If the  light is off

Press the  button for six seconds until the print head moves. The print head moves to the ink cartridge replacement position. Proceed to step 4.

Note:

To cancel ink cartridge replacement, keep the ink cartridges installed and turn off the printer.

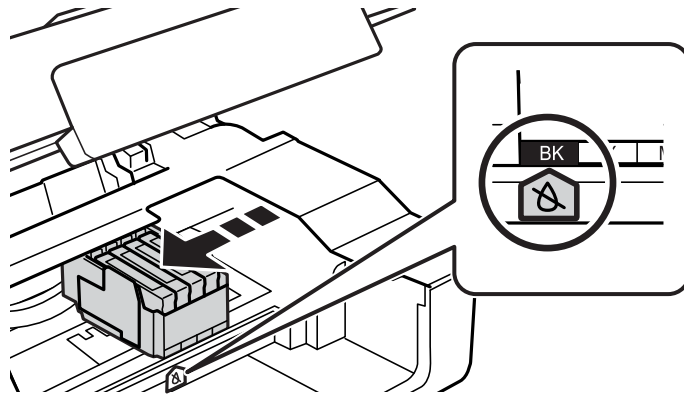

3. Press the  button again.

The print head moves to the ink cartridge replacement position.

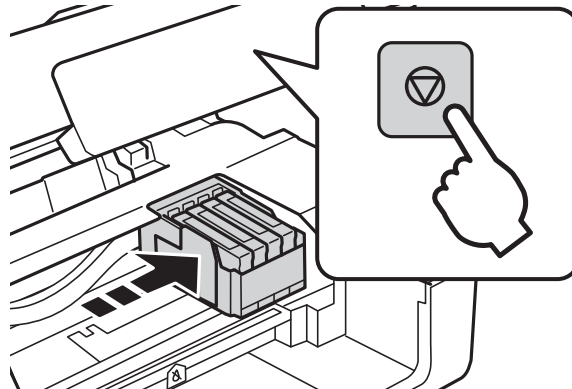

Replacing Ink Cartridges

- When replacing the black ink cartridge, gently shake the new black ink cartridge four or five times and then remove it from its package. When replacing other color cartridges, remove the new color cartridges from their package without shaking.

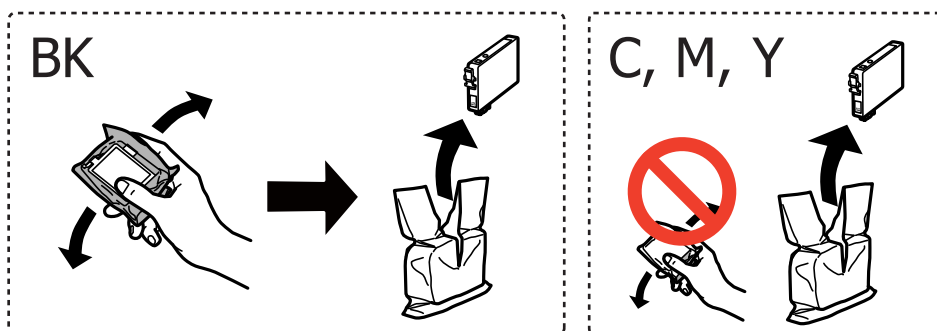

- Remove only the yellow tape.

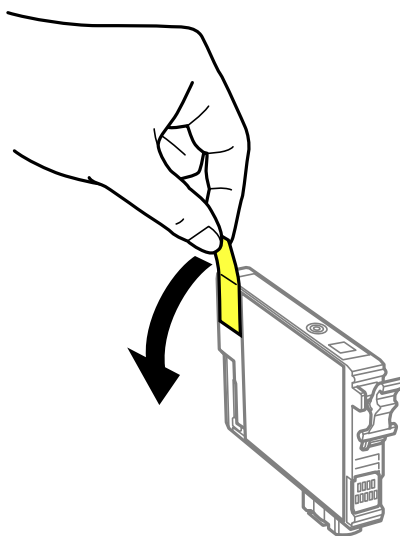

! **Important:**

- Do not touch the sections shown in the illustration. Doing so may prevent normal operation and printing.



- Do not shake cartridges after opening the package, as they may leak.

Replacing Ink Cartridges

6. Squeeze the tab on the ink cartridge and pull it straight up. If you cannot remove the ink cartridge, pull it firmly.

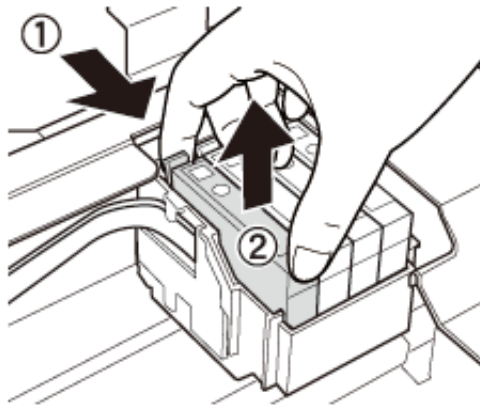

7. Insert the new ink cartridge, and then press it down firmly.

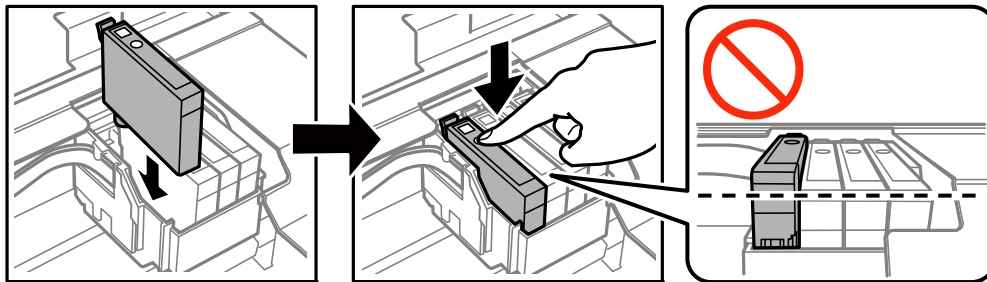

8. Close the scanner unit.

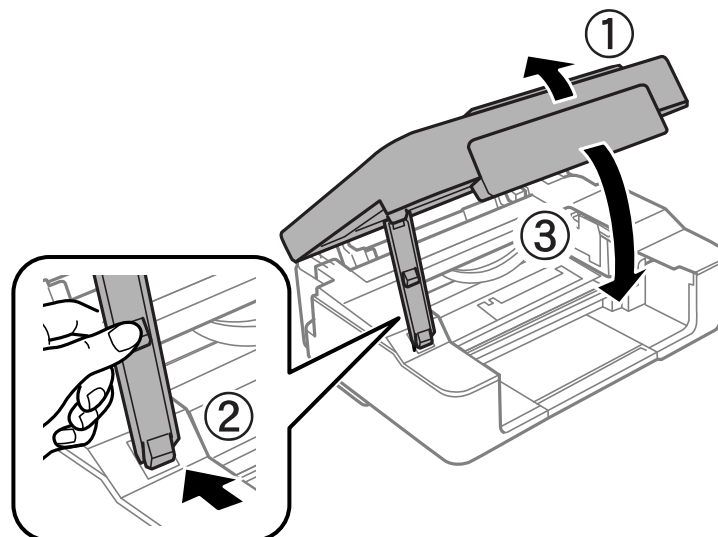

9. Press the  button.
Ink charging starts.

Replacing Ink Cartridges

! **Important:**

After installing the ink cartridge, the power light continues to flash while the printer is charging ink. Do not turn off the printer during ink charging. Charging takes approximately two minutes. If the ink charging is incomplete, you may not be able to print.

Note:

- If the  light does not turn off, try removing and reinserting the ink cartridge.
- Put used ink cartridges in a plastic bag and dispose of them according to your local laws and regulations.

Related Information

- ➔ [“Ink Cartridge Codes” on page 53](#)
- ➔ [“Ink Cartridge Handling Precautions” on page 54](#)

Temporarily Printing with Black Ink

When color ink is expended and black ink still remains when printing from a computer, you can use the following settings to continue printing for a short time using only black ink.

- Type of paper: plain papers, Envelope
- Color: **Grayscale**
- Borderless: Not selected
- EPSON Status Monitor 3: Enabled (for Windows only)

Because this feature is only available for approximately five days, replace the expended ink cartridge as soon as possible.

Note:

- If **EPSON Status Monitor 3** is disabled, access the printer driver, click **Extended Settings** on the **Maintenance** tab, and then select **Enable EPSON Status Monitor 3**.
- The available period varies depending on the usage conditions.

Replacing Ink Cartridges

Temporarily Printing with Black Ink - Windows

1. When the following window is displayed, cancel printing.

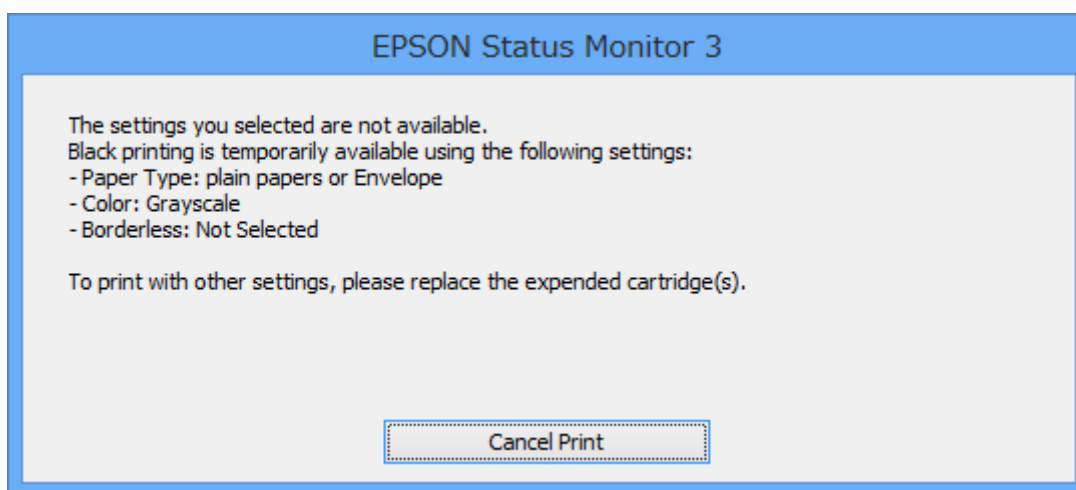
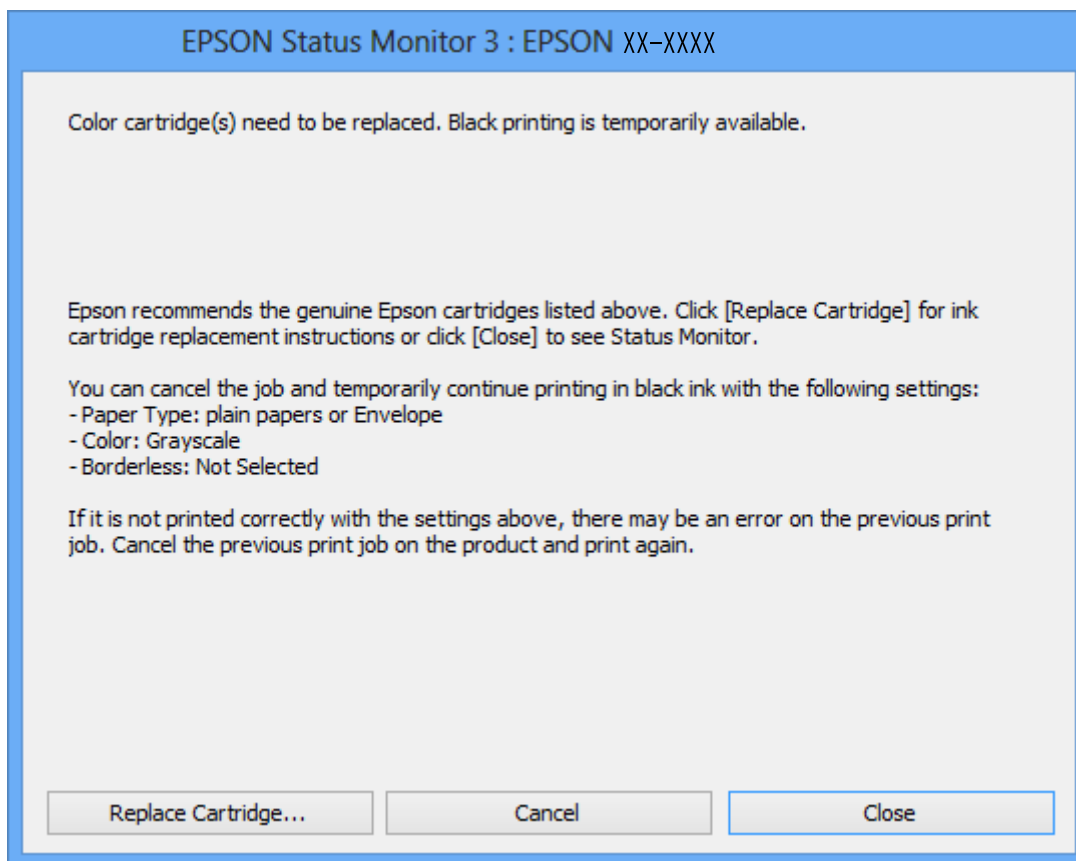
**Note:**

If you cannot cancel printing from the computer, cancel using the printer's control panel.

2. Access the printer driver window.
3. Clear **Borderless** on the **Main** tab.
4. Select **plain papers** or **Envelope** as the **Paper Type** setting on the **Main** tab.

Replacing Ink Cartridges

5. Select **Grayscale**.
6. Set the other items on the **Main** and **More Options** tabs as necessary, and then click **OK**.
7. Click **Print**.
8. Click **Print in Black** in the window displayed.

Related Information

- ➔ [“Loading Paper in the Rear Paper Feed” on page 18](#)
- ➔ [“Printing Basics - Windows” on page 24](#)

Temporarily Printing with Black Ink - Mac OS X

Note:

To use this feature through a network, connect with **Bonjour**.

1. Click the printer icon in the **Dock**.
2. Cancel the job.
 - Mac OS X v10.8.x to Mac OS X v10.9.x
Click  next to the progress meter.
 - Mac OS X v10.6.x to v10.7.x
Click **Delete**.

Note:

If you cannot cancel printing from the computer, cancel using the printer's control panel.

3. Select **System Preferences** from the  menu > **Printers & Scanners** (or **Print & Scan, Print& Fax**), and then select the printer. Click **Options & Supplies > Options** (or **Driver**).
4. Select **On** as the **Permit temporary black printing** setting.
5. Access the printer driver window.
6. Select **Print Settings** from the pop-up menu.
7. Select any paper size except for a borderless size as the **Paper Size** setting.
8. Select **plain papers** or **Envelope** as the **Media Type** setting.
9. Select **Grayscale**.
10. Set the other items as necessary.
11. Click **Print**.

Related Information

- ➔ [“Loading Paper in the Rear Paper Feed” on page 18](#)
- ➔ [“Printing Basics - Mac OS X” on page 25](#)

Conserving Black Ink when the Black Ink Is Low (for Windows Only)

When black ink is running low and there is enough color ink remaining, you can use a mixture of color inks to create black. You can continue printing while preparing a replacement black ink cartridge.

This feature is only available when you select the following settings in the printer driver.

- Paper Type: **plain papers**
- Quality: **Standard**
- EPSON Status Monitor 3: Enabled

Note:

- If **EPSON Status Monitor 3** is disabled, access the printer driver, click **Extended Settings** on the **Maintenance** tab, and then select **Enable EPSON Status Monitor 3**.
- Composite black looks slightly different from pure black. In addition, the print speed is reduced.
- To maintain the quality of the print head, black ink is also consumed.

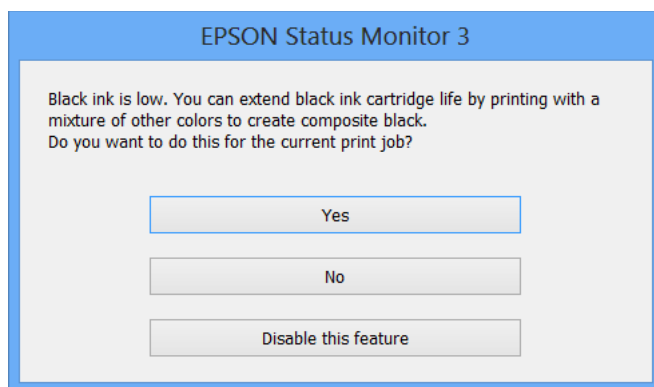

Options	Description
Yes	Select to use a mixture of color inks to create black. This window is displayed the next time you print a similar job.
No	Select to continue using the remaining black ink. This window is displayed the next time you print a similar job.
Disable this feature	Select to continue using the remaining black ink. This window is not displayed until you replace the black ink cartridge and it runs low again.

Improving Print and Scan Quality

Checking and Cleaning the Print Head

If the nozzles are clogged, the printouts become faint, there is visible banding, or unexpected colors appear. When print quality has declined, use the nozzle check feature and check if the nozzles are clogged. If the nozzles are clogged, clean the print head.



! **Important:**

Do not open the scanner unit or turn off the printer during head cleaning. If the head cleaning is incomplete, you may not be able to print.

Note:

- Because print head cleaning uses some ink, clean the print head only if quality declines.
- When ink is low you may not be able to clean the print head. Replace the appropriate ink cartridge first.
- If print quality has not improved after repeating nozzle check and head cleaning about four times, wait for at least six hours without printing, and then run the nozzle check again and repeat the head cleaning if necessary. If the printer operates printing while waiting, extend the waiting time. We recommend to turn off the printer. If print quality has still not improved, contact Epson support.
- To prevent the print head from drying out, always turn the printer off by pressing the  button.
- To keep the print head operating at its best, we recommend printing a few pages on a regular basis.

Checking and Cleaning the Print Head - Printer Buttons

1. Load A4-size plain paper in the printer.
2. Press the  button to turn off the printer.
3. Turn the printer on while holding the  button down, and then release the buttons when the power light flashes.

The nozzle check pattern is printed.

4. Compare the printed check pattern with the sample shown below.
 - All lines are printed: The print head nozzles are not clogged. You do not need to clean the print head.

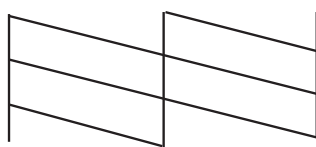

Improving Print and Scan Quality

- ❑ There are broken lines or missing segments: The print head nozzles may be clogged. Go to the next step.

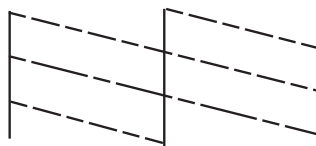

Note:

The test pattern may vary by model.

5. Hold the  button down for three seconds until the power light starts flashing. Print head cleaning starts.
6. When the power light stops flashing, print a nozzle check pattern again. Repeat cleaning and printing the pattern until all lines are printed completely.

Related Information

- ➔ [“Loading Paper in the Rear Paper Feed” on page 18](#)

Checking and Cleaning the Print Head - Windows

1. Load A4-size plain paper in the printer.
2. Access the printer driver window.
3. Click **Nozzle Check** on the **Maintenance** tab.
4. Follow the on-screen instructions.

Related Information

- ➔ [“Loading Paper in the Rear Paper Feed” on page 18](#)
- ➔ [“Windows Printer Driver” on page 69](#)

Checking and Cleaning the Print Head - Mac OS X

1. Load A4-size plain paper in the printer.
2. Select **System Preferences** from the  menu > **Printers & Scanners** (or **Print & Scan, Print & Fax**), and then select the printer.
3. Click **Options & Supplies** > **Utility** > **Open Printer Utility**.
4. Click **Nozzle Check**.
5. Follow the on-screen instructions.

Related Information

➔ [“Loading Paper in the Rear Paper Feed” on page 18](#)

Aligning the Print Head

If you notice a misalignment of vertical lines or blurred images, align the print head.

Aligning the Print Head - Windows

1. Load A4-size plain paper in the printer.
2. Access the printer driver window.
3. Click **Print Head Alignment** on the **Maintenance** tab.
4. Follow the on-screen instructions.

Related Information

➔ [“Loading Paper in the Rear Paper Feed” on page 18](#)

➔ [“Windows Printer Driver” on page 69](#)

Aligning the Print Head - Mac OS X

1. Load A4-size plain paper in the printer.
2. Select **System Preferences** from the  menu > **Printers & Scanners** (or **Print & Scan, Print & Fax**), and then select the printer.
3. Click **Options & Supplies** > **Utility** > **Open Printer Utility**.
4. Click **Print Head Alignment**.
5. Follow the on-screen instructions.

Related Information

➔ [“Loading Paper in the Rear Paper Feed” on page 18](#)

Cleaning the Paper Path

When the printouts are smeared or scuffed or paper does not feed correctly, clean the roller inside.

**Important:**

Do not use tissue paper to clean the inside of the printer. The print head nozzles may be clogged with lint.

1. Make sure there is no any dust or stains on the scanner glass.

Improving Print and Scan Quality

2. Load A4-size plain paper in the printer.
3. Start copying without placing the original.

Note:

Repeat this procedure until the paper is not smeared with ink.

Related Information

- ➔ [“Loading Paper in the Rear Paper Feed” on page 18](#)
- ➔ [“Copying Basics” on page 44](#)

Cleaning the Scanner Glass

When the copies or scanned images are smeared or scuffed, clean the scanner glass.



Important:

Never use alcohol or thinner to clean the printer. These chemicals can damage the printer.

1. Open the document cover.

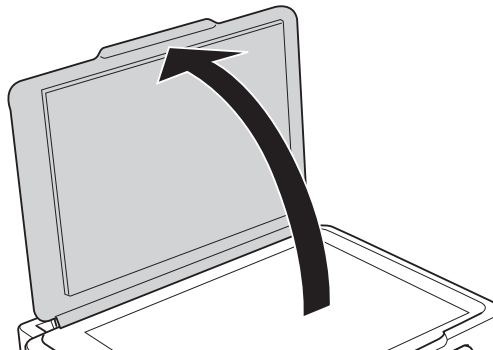

2. Use a soft, dry, clean cloth to clean the surface of the scanner glass.

Note:

- If the glass surface is stained with grease or some other hard-to-remove material, use a small amount of glass cleaner and a soft cloth to remove it. Wipe off all remaining liquid.*
- Do not press the glass surface too hard.*
- Be careful not to scratch or damage the surface of the glass. A damaged glass surface can decrease the scan quality.*

Applications and Network Service Information

Epson Connect Service

Using Epson Connect, you can print from your smartphone, tablet PC, or laptop, anytime and practically anywhere.

The following features are available for your printer.

Email Print	Epson iPrint remote print	Scan to Cloud	Remote Print Driver
✓	✓	–	✓

See the Epson Connect portal website for details.

<https://www.epsonconnect.com/>

<http://www.epsonconnect.eu> (Europe only)

Web Config

Web Config is an application that allows you to manage the printer status or settings on a Web browser from a computer or smart device. You can confirm the printer status or change the network and printer settings. To use the Web Config, connect the printer and device to the same network.

Note:

The following browsers are supported.

OS	Browser
Windows XP or later	Internet Explorer 8 or later, Firefox ^{*1} , Chrome ^{*1}
Mac OS X v10.6.x or later	Safari ^{*1} , Firefox ^{*1} , Chrome ^{*1}
iOS ^{*1*2}	Safari ^{*1}
Android 2.3 or later ^{*2}	Default browser
Chrome OS ^{*1}	Default browser

*1 Use the latest version.

*2 Displays basic settings only

Running Web Config on a Web Browser

1. Check the printer's IP address.

Press the  button to print the network status sheet, and then check the printer's IP address.

Applications and Network Service Information

2. Launch a Web browser from a computer or smart device, and then enter the printer's IP address.

Format:

IPv4: `http://the printer's IP address/`

IPv6: `http://[the printer's IP address]/`

Examples:

IPv4: `http://192.168.100.201/`

IPv6: `http://[2001:db8::1000:1]/`

Note:

Using the smart device, you can also run Web Config from the maintenance screen of Epson iPrint.

Related Information

- ➔ [“Using Epson iPrint” on page 41](#)

Running Web Config on Windows

1. Access the devices and printers screen in Windows.
 - Windows 8.1/Windows 8
Select **Desktop > Settings > Control Panel > View devices and printers in Hardware and Sound (or Hardware)**.
 - Windows 7
Click the start button, and select **Control Panel > View devices and printers in Hardware and Sound**.
 - Windows Vista
Click the start button, and select **Control Panel > Printers in Hardware and Sound**.
2. Right-click on your printer and select **Properties**.
3. Select the **Web Service** tab and click the URL.

Running Web Config on Mac OS X

1. Select **System Preferences** from the  menu > **Printers & Scanners** (or **Print & Scan, Print & Fax**), and then select the printer.
2. Click **Options & Supplies > Show Printer Webpage**.

Necessary Applications

Windows Printer Driver

The printer driver is an application that controls the printer according to the print commands from other applications. Making settings on the printer driver provides the best printing results. You can also check the status of the printer or keep it in top operating condition using the printer driver utility.

Applications and Network Service Information

Note:

You can change the language of the printer driver. Select the language you want to use from the **Language** setting on the **Maintenance** tab.

Accessing the printer driver from applications

To make settings that apply only to the application you are using, access from that application.

Select **Print** or **Print Setup** from the **File** menu. Select your printer, and then click **Preferences** or **Properties**.

Note:

Operations differ depending on the application. See the application's help for details.

Accessing the printer driver from the control panel

To make settings that apply to all of the applications, access from the control panel.

Windows 8.1/Windows 8

Select **Desktop > Settings > Control Panel > View devices and printers in Hardware and Sound**. Right-click on your printer, or press and hold it and then select **Printing preferences**.

Windows 7

Click the start button, and select **Control Panel > View devices and printers in Hardware and Sound**. Right-click on your printer and select **Printing preferences**.

Windows Vista

Click the start button, and select **Control Panel > Printers in Hardware and Sound**. Right-click on your printer and select **Printing preferences**.

Windows XP

Click the start button, and select **Control Panel > Printers and Other Hardware > Printers and Faxes**. Right-click on your printer and select **Printing preferences**.

Accessing the printer driver from the printer icon on the task bar (Windows)

The printer icon on the desktop task bar is a shortcut icon allowing you to quickly access the printer driver.

If you click the printer icon and select **Printer Settings**, you can access the same printer settings window as the one displayed from the control panel. If you double-click this icon, you can check the status of the printer.

Note:

If the printer icon is not displayed on the task bar, access the printer driver window, click **Monitoring Preferences** on the **Maintenance** tab, and then select **Register the shortcut icon to the taskbar**.

Guide to Windows Printer Driver

Help is available in the printer driver for Windows. To view explanations of the setting items, right-click on each item, and then click **Help**.

Main Tab

You can make basic settings for printing, such as paper type or paper size.

Applications and Network Service Information

You can also make settings for printing both sides of the paper or printing multiple pages on one sheet.

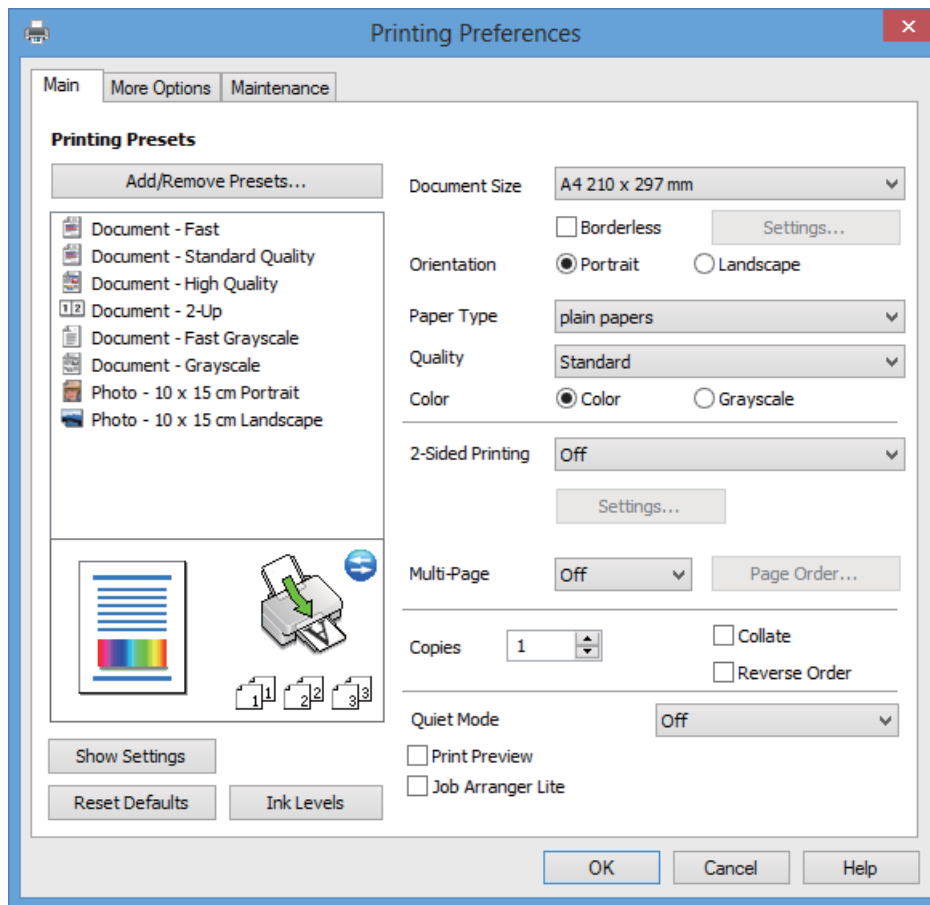

Applications and Network Service Information

More Options Tab

You can select additional layout and printing options such as changing the size of a printout or making color corrections.

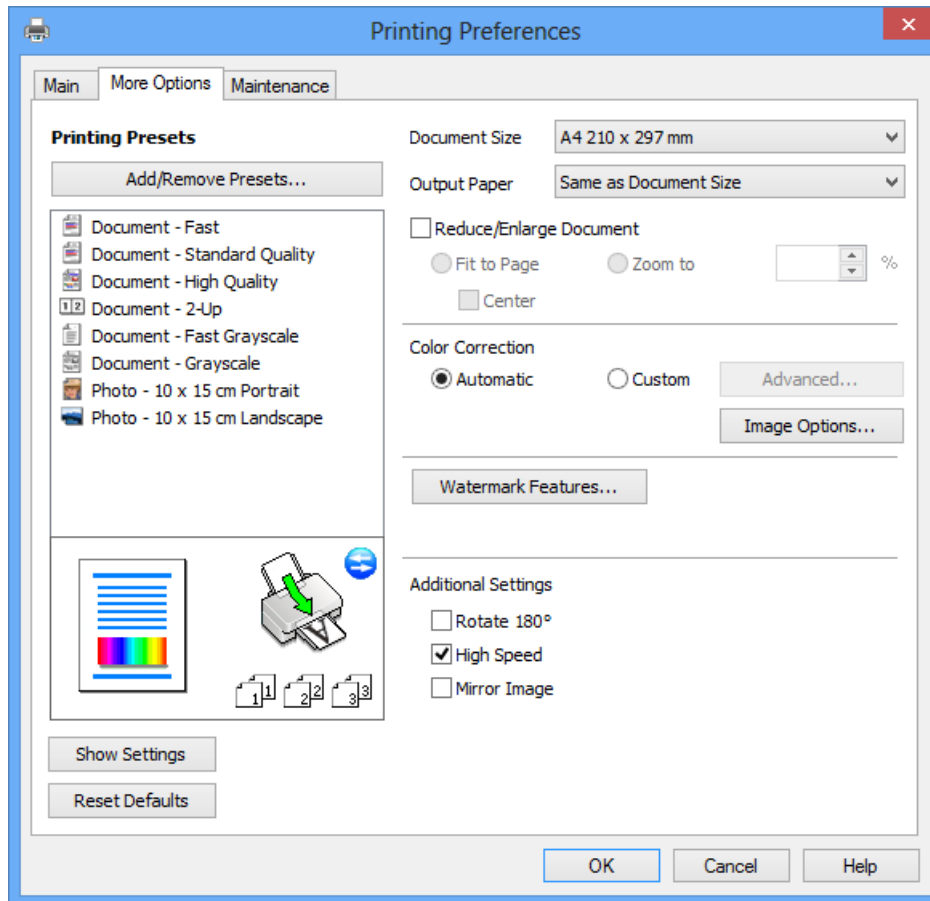

Applications and Network Service Information

Maintenance Tab

You can check the approximate ink levels and error information, and also maintain your printer, such as nozzle check or print head cleaning.

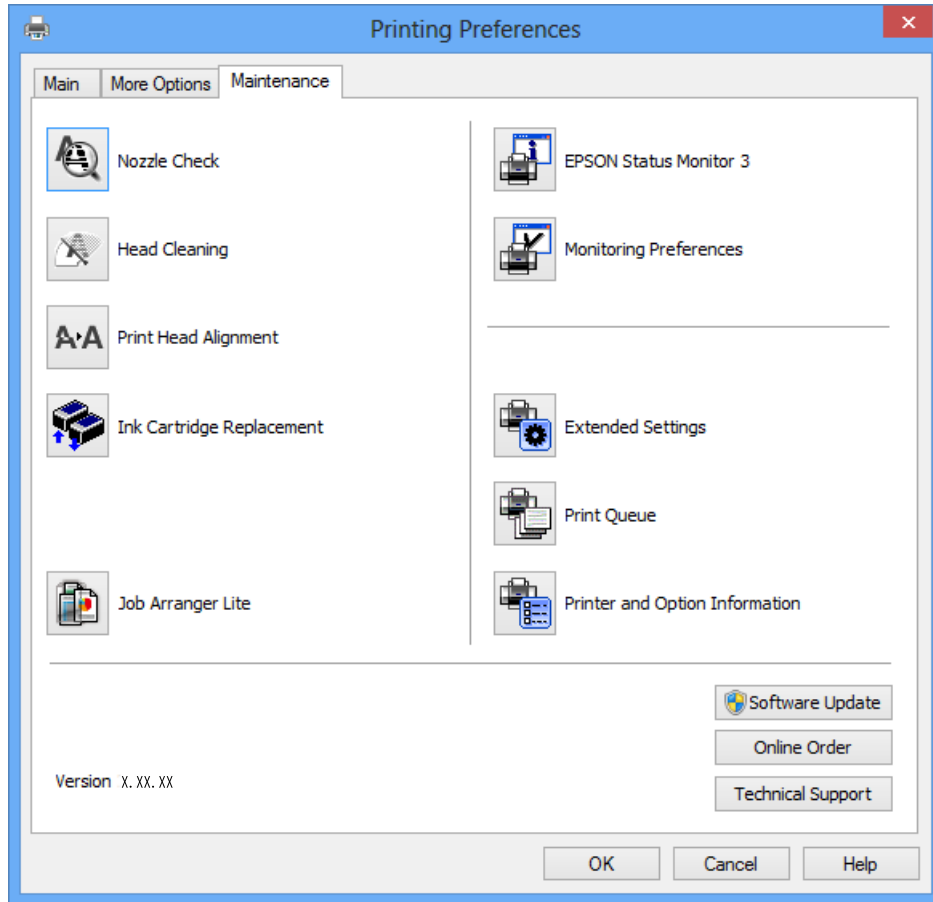

Making Operation Settings for the Windows Printer Driver

You can make settings such as enabling **EPSON Status Monitor 3**.

1. Access the printer driver window.
2. Click **Extended Settings** on the **Maintenance** tab.
3. Make the appropriate settings, and then click **OK**.
See the online help for explanations of the setting items.

Related Information

➔ [“Windows Printer Driver” on page 69](#)

Mac OS X Printer Driver

The printer driver is an application that controls the printer according to the print commands from other applications. Making settings on the printer driver provides the best printing results. You can also check the status of the printer or keep it in top operating condition using the printer driver utility.

Applications and Network Service Information

Accessing the printer driver from applications

Select **Print** from the **File** menu. If necessary, click **Show Details** (or ▼) to expand the print window.

Note:

Operations differ depending on the application. See the application's help for details.

Starting the utility

Select **System Preferences** from the  menu > **Printers & Scanners** (or **Print & Scan, Print & Fax**), and then select the printer. Click **Options & Supplies** > **Utility** > **Open Printer Utility**.

Guide to Mac OS X Printer Driver

Printer Driver Screen

Switch the pop-up menu on the center of the screen to show more items.

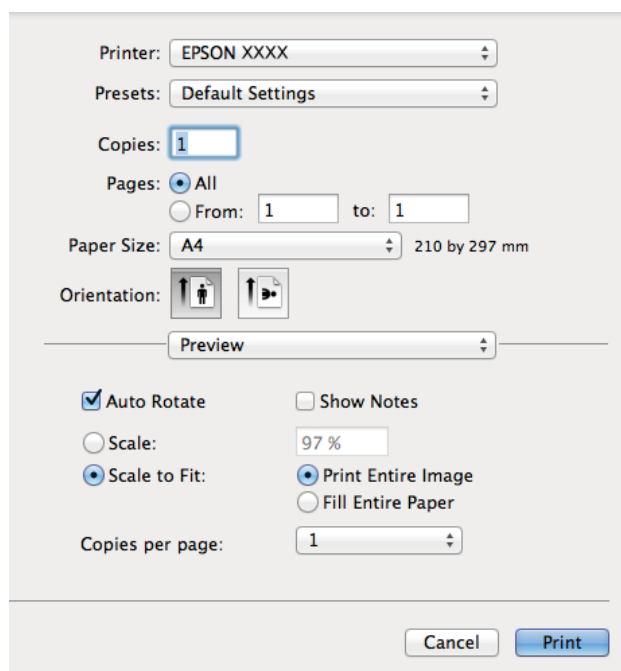

Pop-up Menu	Descriptions
Print Settings	You can make basic settings for printing, such as paper type or borderless printing.
Two-sided Printing Settings	You can select a binding direction for 2-sided printing or select a document type.
Layout	You can select a layout for printing several pages on one sheet or select to print a border.
Paper Handling	You can reduce or enlarge the size of the print job to automatically fit the paper size you loaded.
Color Matching	You can adjust the colors.

Applications and Network Service Information

Note:

On Mac OS X v10.8.x or later, if **Print Settings** menu is not displayed, Epson printer driver has not been installed correctly.

Select **System Preferences** from the  menu > **Printers & Scanners** (or **Print & Scan**, **Print & Fax**), remove the printer, and then add the printer again. See the following to add a printer.

<http://support.epson.net/setupnavi/>

Epson Printer Utility

You can check the approximate ink levels and error information, and also maintain your printer, such as nozzle check or print head cleaning.

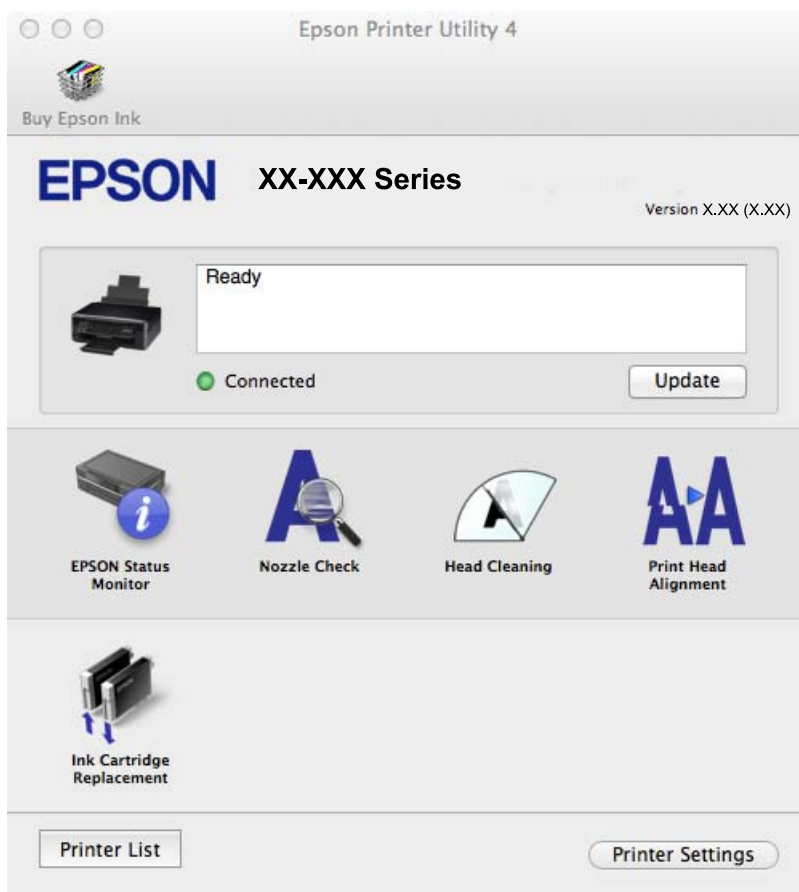

Making Operation Settings for the Mac OS X Printer Driver

You can make various settings such as skipping blank pages and enabling/disabling high speed printing.

1. Select **System Preferences** from the  menu > **Printers & Scanners** (or **Print & Scan**, **Print & Fax**), and then select the printer. Click **Options & Supplies** > **Options** (or **Driver**).
2. Make the appropriate settings, and then click **OK**.
 - Thick paper and envelopes: Prevents the ink from smearing when printing on thick paper. However, the print speed may be slower.
 - Skip Blank Page: Avoids printing blank pages.
 - Quiet Mode: Prints quietly. However, the print speed may be slower.
 - Permit temporary black printing: Prints only with black ink temporarily.

Applications and Network Service Information

- High Speed Printing: Prints when the print head moves in both directions. The print speed is faster, but the quality may decline.
- Remove white borders: Removes unnecessary margins during borderless printing.
- Warning Notifications: Allows the printer driver to display warning notifications.
- Establish bidirectional communication: Usually, this should be set to **On**. Select **Off** when acquiring the printer information is impossible because the printer is shared with Windows computers on a network or for any other reason.
- Lower Cassette: Add the optional paper cassette units to the paper source.

Note:

The availability of these settings varies by model.

Related Information

➔ [“Temporarily Printing with Black Ink” on page 60](#)

EPSON Scan (Scanner Driver)

EPSON Scan is an application for controlling scanning. You can adjust the size, resolution, brightness, contrast, and quality of the scanned image.

Note:

You can also start EPSON Scan from a TWAIN-compliant scanning application.

Starting on Windows

- Windows 8.1/Windows 8

Enter the application name in the search charm, and then select the displayed icon.

- Except for Windows 8.1/Windows 8

Click the start button, and select **All Programs** or **Programs > EPSON > EPSON Scan > EPSON Scan**.

Starting on Mac OS X

Note:

EPSON Scan does not support the Mac OS X fast user switching feature. Turn off fast user switching.

Select **Go > Applications > Epson Software > EPSON Scan**.

Epson Event Manager

Epson Event Manager is an application that allows you to manage scanning from the control panel and save images to a computer. You can add your own settings as presets, such as the document type, the save folder location, and the image format. See the application's help for details.

Starting on Windows

- Windows 8.1/Windows 8

Enter the application name in the search charm, and then select the displayed icon.

- Except for Windows 8.1/Windows 8

Click the start button, and select **All Programs** or **Programs > Epson Software > Event Manager**.

Applications and Network Service Information

Starting on Mac OS X

Select **Go > Applications > Epson Software > Event Manager**.

Related Information

➔ [“Scanning from the Control Panel” on page 45](#)

Epson Easy Photo Print

Epson Easy Photo Print is an application that allows you to easily print photos with various layouts. You can preview the photo image and adjust the images or position. You can also print photos with a frame. See the application's help for details.

Note:

To use this application, the printer driver needs to be installed.

Starting on Windows

- Windows 8.1/Windows 8

Enter the application name in the search charm, and then select the displayed icon.

- Except for Windows 8.1/Windows 8

Click the start button, and then select **All Programs** or **Programs > Epson Software > Epson Easy Photo PrintE-Photo**.

Starting on Mac OS X

Select **Go > Applications > Epson Software > Epson Easy Photo Print**.

E-Web Print (for Windows Only)

E-Web Print is an application that allows you to easily print web pages with various layouts. See the application's help for details. You can access the help from the **E-Web Print** menu on the **E-Web Print** tool bar.

Starting

When you install E-Web Print, it is displayed in your browser. Click **Print** or **Clip**.

Easy Photo Scan

Easy Photo Scan is an application that allows you to scan photos and easily send the scanned image to a computer or cloud service. You can also easily adjust the scanned image. See the application's help for details.

Note:

To use this application, the scanner driver EPSON Scan needs to be installed.

Starting on Windows

- Windows 8.1/Windows 8

Enter the application name in the search charm, and then select the displayed icon.

- Except for Windows 8.1/Windows 8

Click the start button, and select **All Programs** or **Programs > Epson Software > Easy Photo Scan**.

Applications and Network Service Information

Starting on Mac OS X

Select **Go > Applications > Epson Software > Easy Photo Scan**.

EPSON Software Updater

EPSON Software Updater is an application that checks for new or updated software on the internet and installs it. You can also update the printer's firmware and manual.

Starting on Windows

- Windows 8.1/Windows 8

Enter the application name in the search charm, and then select the displayed icon.

- Except for Windows 8.1/Windows 8

Click the start button, and select **All Programs (or Programs) > Epson Software > EPSON Software Updater**.

Note:

*You can also start EPSON Software Updater by clicking the printer icon on the task bar on the desktop, and then selecting **Software Update**.*

Starting on Mac OS X

Select **Go > Applications > Epson Software > EPSON Software Updater**.

Uninstalling Applications

Note:

Log on to your computer as an administrator. Enter the administrator password if the computer prompts you.

Uninstalling Applications - Windows

1. Press the  button to turn off the printer.
2. Quit all running applications.
3. Open **Control Panel**:
 - Windows 8.1/Windows 8
Select **Desktop > Settings > Control Panel**.
 - Except for Windows 8.1/Windows 8
Click the start button and select **Control Panel**.
4. Open **Uninstall a program (or Add or Remove Programs)**:
 - Windows 8.1/Windows 8/Windows 7/Windows Vista
Select **Uninstall a program** in **Programs**.
 - Windows XP
Click **Add or Remove Programs**.
5. Select the application you want to uninstall.

Applications and Network Service Information



- Uninstall the applications:
 - Windows 8.1/Windows 8/Windows 7/Windows Vista
Click **Uninstall/Change** or **Uninstall**.
 - Windows XP
Click **Change/Remove** or **Remove**.

Note:

If the **User Account Control** window is displayed, click **Continue**.

- Follow the on-screen instructions.

Uninstalling Applications - Mac OS X

- Download the Uninstaller using EPSON Software Updater.
Once you have downloaded the Uninstaller, you do not need to download it again each time you uninstall the application.
- Turn off the printer by pressing the  button.
- To uninstall the printer driver, select **System Preferences** from the  menu > **Printers & Scanners** (or **Print & Scan, Print & Fax**), and then remove the printer from the enabled printers list.
- Quit all running applications.
- Select **Go > Applications > Epson Software > Uninstaller**.
- Select the application you want to uninstall, and then click **Uninstall**.



Important:

The Uninstaller removes all drivers for Epson inkjet printers on the computer. If you use multiple Epson inkjet printers and you only want to delete some drivers, delete all of them first, and then install the necessary printer driver again.

Note:

If you cannot find the application you want to uninstall in the application list, you cannot uninstall using the Uninstaller. In this situation, select **Go > Applications > Epson Software**, select the application you want to uninstall, and then drag it to the trash icon.

Related Information

➔ [“EPSON Software Updater” on page 78](#)

Installing Applications

If your computer is connected to a network, install the latest applications available on the website. If you are unable to download the applications from the website, install them from the software disc that came with the printer.

Note:

- Log on to your computer as an administrator. Enter the administrator password if the computer prompts you.
- When reinstalling an application, you need to uninstall it first.

Applications and Network Service Information

1. Quit all running applications.
2. When installing the printer driver or EPSON Scan, disconnect the printer and the computer temporarily.

Note:

Do not connect the printer and the computer until you are instructed to do so.

3. Install the applications by following the instructions on the website below.

<http://support.epson.net/setupnavi/>

Related Information

➔ [“Uninstalling Applications” on page 78](#)

Updating Applications and Firmware

You may be able to clear certain problems and improve or add functions by updating the applications and the firmware. Make sure you use the latest version of the applications and firmware.

1. Make sure that the printer and the computer are connected, and the computer is connected to the internet.
2. Start EPSON Software Updater, and update the applications or the firmware.



Important:

Do not turn off the computer or the printer while updating.

Note:

If you cannot find the application you want to update in the list, you cannot update using the EPSON Software Updater. Check for the latest versions of the applications from your local Epson website.

<http://www.epson.com>

Related Information

➔ [“EPSON Software Updater” on page 78](#)

Solving Problems

Checking the Printer Status













Checking the Error Indicators on the Printer

When an error occurs, the light turns on or flashes. Details of the error are displayed on the computer screen.



 : On

 : Flashing slowly

 : Flashing Fast

Light	Situation	Solutions
	No paper is loaded or more than one sheet has been fed at a time.	Load paper and press the  or  button.
	A paper jam has occurred.	Remove the paper and press the  or  button.
	An ink cartridge is expended or there is insufficient ink in the cartridge to charge the ink.	To ensure you receive premium print quality and to help protect your print head, a variable ink safety reserve remains in the cartridge when your printer indicates it is time to replace the cartridge. Replace with a new ink cartridge.
	An ink cartridge is not installed.	Install the ink cartridge.
	An ink cartridge has not been recognized.	Press the ink cartridge down firmly.
	An unsupported ink cartridge has been installed.	Install an ink cartridge that is supported by this printer. You cannot use the cartridges that came with your printer for replacement.
	An ink cartridge is nearly expended. You can print until the  light turns on.	Prepare a new ink cartridge. You can check the ink levels from the computer.
	The  light and  light flash alternately. An ink pad is nearing or at the end of its service life.	The ink pads need to be replaced. Contact Epson or an authorised Epson service provider to replace the ink pad*. It is not a user-serviceable part. When a message saying that you can continue printing is displayed on the computer, press the  button to continue printing. The lights stop flashing for the time being, however, they will continue to flash at regular intervals until the ink pad is replaced.

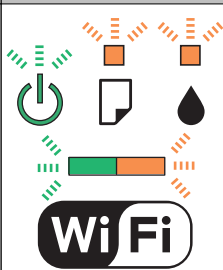
Solving Problems

Light	Situation	Solutions
	A printer error has occurred.	Open the scanner unit and remove any paper or protective material inside the printer. Turn the power off and on again.
	A Wi-Fi connection error has occurred.	Press the Wi-Fi button to clear the error and try again. See the <i>Network Guide</i> for more details.
	The printer has started in recovery mode because the firmware update failed.	Follow the steps below to try to update the firmware again. <ul style="list-style-type: none"> 1. Connect the computer and the printer with a USB cable. (During recovery mode, you cannot update the firmware over a network connection.) 2. Visit your local Epson website for further instructions.

* In some print cycles a very small amount of surplus ink may be collected in the ink pad. To prevent ink leakage from the pad, the printer is designed to stop printing when the pad has reached its limit. Whether and how often this is required will vary according to the number of pages you print, the type of material that you print and the number of cleaning cycles that the printer performs. The need for replacement of the pad does not mean that your printer has ceased to operate in accordance with its specifications. The printer will advise you when the pad requires replacing and this can only be performed by an authorised Epson Service provider. The Epson warranty does not cover the cost of this replacement.

Related Information

- ➔ [“Removing Jammed Paper” on page 83](#)
- ➔ [“Contacting Epson Support” on page 104](#)
- ➔ [“Installing Applications” on page 79](#)
- ➔ [“Updating Applications and Firmware” on page 80](#)

Checking the Printer Status - Windows

1. Access the printer driver window.
2. Click **EPSON Status Monitor 3** on the **Maintenance** tab.

Note:

- You can also check the printer status by double-clicking the printer icon on the taskbar. If the printer icon is not added to the taskbar, click **Monitoring Preferences** on the **Maintenance** tab, and then select **Register the shortcut icon to the taskbar**.
- If **EPSON Status Monitor 3** is disabled, click **Extended Settings** on the **Maintenance** tab, and then select **Enable EPSON Status Monitor 3**.

Solving Problems

Related Information

➔ [“Windows Printer Driver” on page 69](#)

Checking Printer Status - Mac OS X

1. Select **System Preferences** from the  menu > **Printers & Scanners** (or **Print & Scan**, **Print & Fax**), and then select the printer.
2. Click **Options & Supplies** > **Utility** > **Open Printer Utility**.
3. Click **EPSON Status Monitor**.

Removing Jammed Paper

Check the error displayed on the control panel and follow the instructions to remove the jammed paper including any torn pieces. Next, clear the error.

**Important:**

Remove the jammed paper carefully. Removing the paper vigorously may cause damage to the printer.

Related Information

➔ [“Checking the Error Indicators on the Printer” on page 81](#)

Removing Jammed Paper from the Rear Paper Feed

Remove the jammed paper.

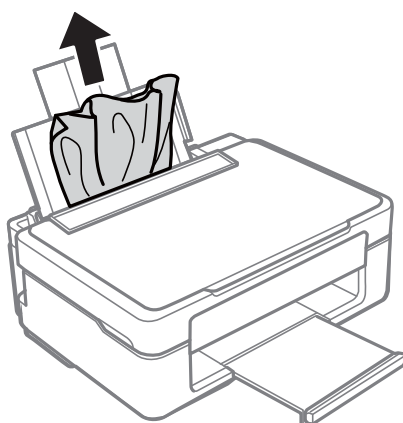

Solving Problems

Removing Jammed Paper from the Output Tray

Remove the jammed paper.

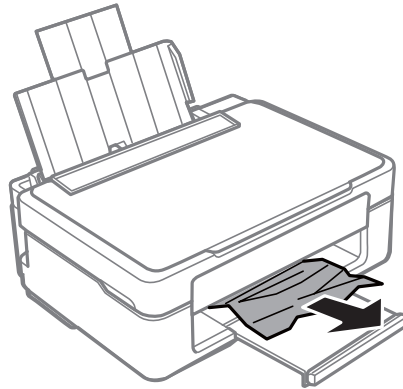

Removing Jammed Paper from Inside the Printer

 **Caution:**

- Be careful not to trap your hand or fingers when opening or closing the scanner unit. Otherwise you may be injured.
- Never touch the buttons on the control panel while your hand is inside the printer. If the printer starts operating, it could cause an injury. Be careful not to touch the protruding parts to avoid injury.

1. Open the scanner unit with the document cover closed.

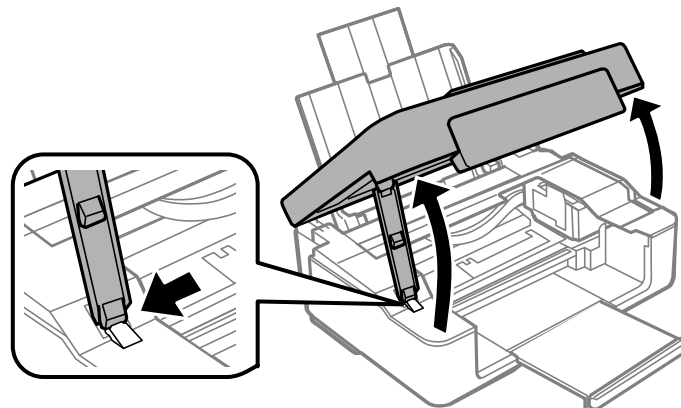

Solving Problems

2. Remove the jammed paper.

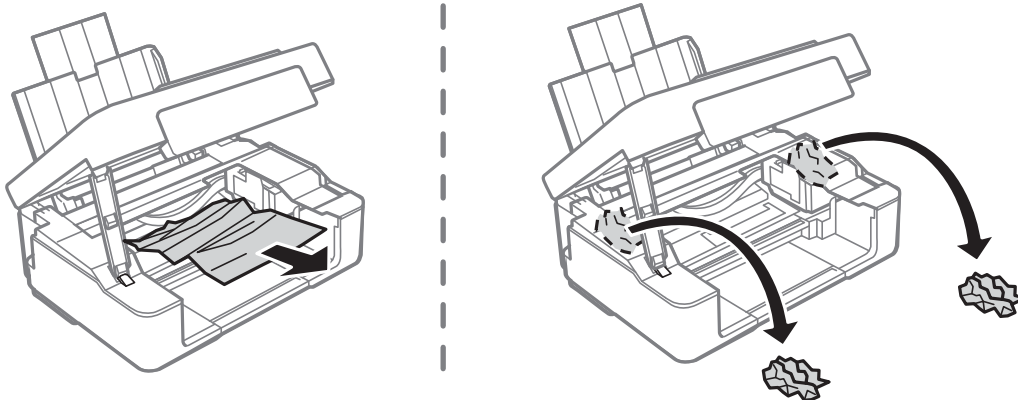

! *Important:*

Do not touch the white flat cable or translucent part inside the printer. Doing so may cause a malfunction.

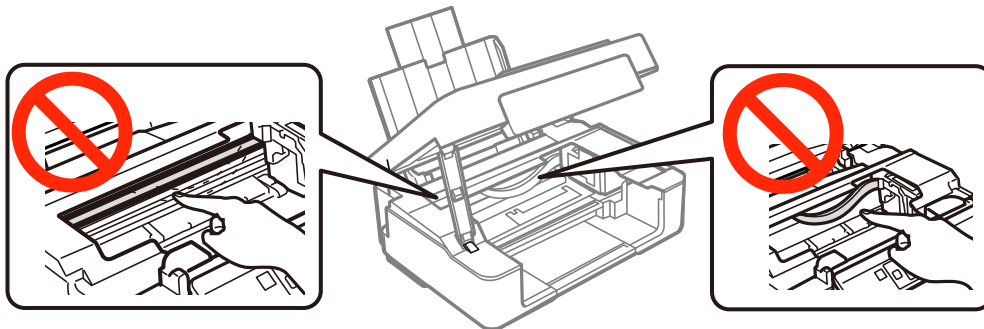

3. Close the scanner unit.

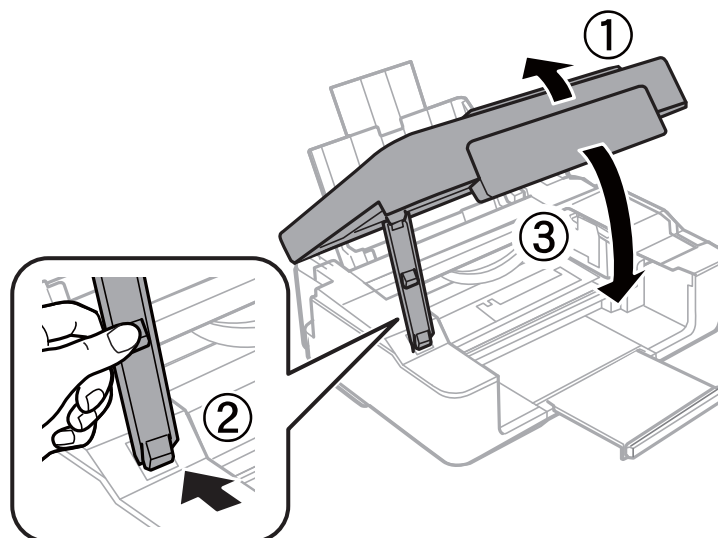

Paper Does Not Feed Correctly

Check the following if the paper jams, paper is fed at a slant, several sheets of paper are fed at a time, no paper is fed, or paper is ejected.

- Place the printer on a flat surface and operate in the recommended environmental conditions.
- Use paper supported by this printer.
- Follow the paper handling precautions.
- Load paper in the correct direction, and slide the edge guide against the edge of the paper.
- Do not load more than the maximum number of sheets specified for the paper. For plain paper, do not load above the line indicated by the triangle symbol on the edge guide.
- When a paper out error occurs although paper is loaded in the printer, reload paper against the right edge of the rear paper feed.
- Load one sheet of paper at a time when loading multiple sheets of paper.
- When several sheets of paper are fed at a time during manual 2-sided printing, remove any paper which is loaded in the paper source before you reload the paper.
- Load and eject paper without printing to clean the paper path.
- Printing may pause for a certain length of time. If printing is paused, the paper is ejected.

Related Information



- ➔ [“Environmental Specifications” on page 99](#)
- ➔ [“Available Paper and Capacities” on page 17](#)
- ➔ [“Paper Handling Precautions” on page 16](#)
- ➔ [“Loading Paper in the Rear Paper Feed” on page 18](#)
- ➔ [“Cleaning the Paper Path” on page 66](#)

Power and Control Panel Problems

Power Does Not Turn On

- Hold down the  button for a little longer.
- Make sure the power cord is securely plugged in.

Power Does Not Turn Off

Hold down the  button for a little longer. If you still cannot turn off the printer, unplug the power cord. To prevent the print head from drying out, turn the printer back on and turn it off by pressing the  button.

Printer Does Not Print

Check the following if the printer does not operate or prints nothing.

Solving Problems

- Install the printer driver.
- To print photos easily, install Epson Easy Photo Print.
- Connect the interface cable securely to the printer and the computer.
- If you are using a USB hub, try to connect the printer directly to the computer.
- If you are using the printer over a network, make sure the printer is connected to the network. You can check the status by checking the indicators on the control panel or by printing the network status sheet. If the printer is not connected to the network, see the *Network Guide*.
- If you are printing a large image, the computer may not have enough memory. Print the image at a lower resolution or a smaller size.
- In Windows, click **Print Queue** on the printer driver's **Maintenance** tab, and then check the following.
 - Check if there are any paused print jobs.
Cancel printing if necessary.
 - Make sure the printer is not offline or pending.
If the printer is offline or pending, clear the offline or pending setting from the **Printer** menu.
 - Make sure the printer is selected as the default printer from the **Printer** menu (there should be a check mark on the menu item).
If the printer is not selected as the default printer, set it as the default printer.
- In Mac OS X, make sure the printer status is not **Pause**.
Select **System Preferences** from the  menu > **Printers & Scanners** (or **Print & Scan**, **Print & Fax**), and then double-click the printer. If the printer is **paused**, click **Resume** (or **Resume Printer**).
- Run the nozzle check, and then clean the print head if any of the print head nozzles are clogged.

Related Information

- ➔ [“Installing Applications” on page 79](#)
- ➔ [“Epson Easy Photo Print” on page 77](#)
- ➔ [“Canceling Printing” on page 42](#)
- ➔ [“Checking and Cleaning the Print Head” on page 64](#)
- ➔ [“Web Config” on page 68](#)



Printout Problems

Print Quality Is Poor

Check the following if the print quality is poor due to blurry prints, banding, missing colors, faded colors, misalignment, and mosaic-like patterns in the prints.

- Run the nozzle check, and then clean the print head if any of the print head nozzles are clogged.
- Align the print head.
- Use paper supported by this printer.
- Do not print on paper that is damp, damaged, or too old.
- If the paper is curled or the envelope is puffed up, flatten it.

Solving Problems

- ❑ When printing images or photos, print using high-resolution data. Images on websites are often low resolution although they look good enough on the display, and so print quality may decline.
- ❑ Select the appropriate paper type setting in the printer driver for the type of paper loaded in the printer.
- ❑ Print using a high quality setting in the printer driver.
- ❑ If you hold down the  or  button for more than three seconds, the printer copies in draft mode and banding may appear on the printout.
- ❑ When images or photos are printed in unexpected colors, adjust the color and then print again. The automatic color correction feature uses the standard **PhotoEnhance** correction mode. Try another **PhotoEnhance** correction mode by selecting an option other than **Auto Correct** as the **Scene Correction** setting. If the problem continues, use any other color correction feature other than **PhotoEnhance**.
 - ❑ Windows

Select **Custom** as the **Color Correction** setting on the printer driver's **More Options** tab. Click **Advanced**, and then select anything other than **PhotoEnhance** as the **Color Management** setting.
 - ❑ Mac OS X

Select **Color Matching** from the printer driver's pop-up menu, and then select **EPSON Color Controls**. Select **Color Options** from the pop-up menu, and then select anything other than **PhotoEnhance**.
- ❑ Disable the bidirectional (or high speed) setting. When this setting is enabled, the print head prints while moving in both directions, and vertical lines may be misaligned. If you disable this feature, printing may slow down.
 - ❑ Windows

Clear **High Speed** on the printer driver's **More Options** tab.
 - ❑ Mac OS X

Select **System Preferences** from the  menu > **Printers & Scanners** (or **Print & Scan, Print & Fax**), and then select the printer. Click **Options & Supplies** > **Options** (or **Driver**). Select **Off** as the **High Speed Printing** setting.
- ❑ Do not stack the paper immediately after printing.
- ❑ Dry the printouts completely before filing or displaying them. When drying the printouts, avoid direct sun light, do not use a dryer, and do not touch the printed side of paper.
- ❑ Try to use genuine Epson ink cartridges. This product is designed to adjust colors based on the use of genuine Epson ink cartridges. The use of non-genuine ink cartridges may cause print quality to decline.
- ❑ Epson recommends using the ink cartridge before the date printed on the package.
- ❑ For best results, use up ink cartridge within six months of opening the package.
- ❑ When printing images or photos, Epson recommends using genuine Epson paper rather than plain paper. Print on the printable side of the genuine Epson paper.

Related Information

- ➔ [“Checking and Cleaning the Print Head” on page 64](#)
- ➔ [“Aligning the Print Head” on page 66](#)
- ➔ [“Available Paper and Capacities” on page 17](#)
- ➔ [“Paper Handling Precautions” on page 16](#)
- ➔ [“List of Paper Types” on page 18](#)

Solving Problems

Copy Quality Is Poor

Check the following if uneven colors, smears, dots, or straight lines appear in the copied image.

- Load and eject paper without printing to clean the paper path.
- Clean the scanner glass and the document cover.
- Do not press too hard on the original or the document cover when you are placing the originals on the scanner glass. Uneven colors, smears, or dots may appear when the original or the document cover are pressed too hard.
- If banding appears at intervals of 2.5 cm, align the print head.
- If a moire (cross-hatch) pattern appears, change the reduce and enlarge setting or place the original at a slightly different angle.

Related Information

- ➔ [“Cleaning the Paper Path” on page 66](#)
- ➔ [“Cleaning the Scanner Glass” on page 67](#)
- ➔ [“Aligning the Print Head” on page 66](#)
- ➔ [“Print Quality Is Poor” on page 87](#)

An Image of the Reverse Side of the Original Appears in the Copied Image

- For a thin original, place the original on the scanner glass and then place a piece of black paper over it.

The Position, Size, or Margins of the Printout Are Incorrect

- Load paper in the correct direction, and slide the edge guides against the edges of the paper.
- When placing the originals on the scanner glass, align the corner of the original with the corner indicated by a symbol on the frame of the scanner glass. If the edges of the copy are cropped off, move the original slightly away from the corner.
- Clean the scanner glass and the document cover. If there is dust or stains on the glass, the copy area may extend to include the dust or stains, resulting in the wrong printing position or small images.
- Select the appropriate paper size setting in the printer driver.
- Adjust the margin setting in the application so that it falls within the printable area.
- If you want to print with no margins, make settings for borderless printing.
 - Windows
Select **Borderless** on the printer driver's **Main** tab. If you select a paper type unavailable for borderless printing, you cannot select this check box. Select the paper available for borderless printing.
 - Mac OS X
Select a paper size for borderless printing as the **Paper Size** setting on the printer driver.

Solving Problems

- During borderless printing, the image is slightly enlarged and the protruding area is cropped. Adjust the amount of enlargement.
 - Windows
Click **Settings** of the **Borderless** on the printer driver's **Main** tab and select the amount of enlargement.
 - Mac OS X
Select the **Print Settings** menu on the printer driver and select the amount of enlargement on the **Expansion** setting.

Related Information

- ➔ [“Loading Paper in the Rear Paper Feed” on page 18](#)
- ➔ [“Placing Originals on the Scanner Glass” on page 22](#)
- ➔ [“Cleaning the Scanner Glass” on page 67](#)
- ➔ [“Printable Area” on page 96](#)
- ➔ [“Available Paper and Capacities” on page 17](#)

Paper Is Smearred or Scuffed

Check the following if the paper is smeared or scuffed when printing.

- Clean the paper path.
- Clean the scanner glass and the document cover.
- Load paper in the correct direction.
- When performing manual 2-sided printing, make sure that the ink is completely dry before reloading the paper.

Related Information

- ➔ [“Cleaning the Paper Path” on page 66](#)
- ➔ [“Cleaning the Scanner Glass” on page 67](#)
- ➔ [“Loading Paper in the Rear Paper Feed” on page 18](#)
- ➔ [“Print Quality Is Poor” on page 87](#)

Printed Characters Are Incorrect or Garbled

- Connect the interface cable securely to the printer and the computer.
- Cancel any paused print jobs.
- Do not put the computer manually into the **Hibernate** mode or the **Sleep** mode while printing. Pages of garbled text may be printed next time you start the computer.

Related Information

- ➔ [“Canceling Printing” on page 42](#)

The Printed Image Is Inverted

Clear any mirror image settings in the printer driver or the application.

Solving Problems

Windows

Clear **Mirror Image** on the printer driver's **More Options** tab.

Mac OS X

Clear **Mirror Image** from the printer driver's **Print Settings** menu.

The Printout Problem Could Not be Cleared

If you have tried all of the solutions and have not solved the problem, try uninstalling and then reinstalling the printer driver.

Related Information

➔ [“Uninstalling Applications” on page 78](#)

➔ [“Installing Applications” on page 79](#)

Printing Is Too Slow

When printing continuously for approximately more than 30 minutes, printing slows down to prevent the printer mechanism from overheating and being damaged. However, you can continue printing. To return the printer to normal printing speed, cancel printing, and leave the printer idle for at least 30 minutes with the power on. The printer does not recover if the power is off.

Close any unnecessary applications.

Lower the quality setting on the printer driver. High quality printing slows down the printing speed.

Enable the bidirectional (or high speed) setting. When this setting is enabled, the print head prints while moving in both directions, and the printing speed increases.

Windows

Select **High Speed** on the printer driver's **More Options** tab.

Mac OS X

Select **System Preferences** from the  menu > **Printers & Scanners** (or **Print & Scan, Print & Fax**), and then select the printer. Click **Options & Supplies** > **Options** (or **Driver**). Select **On** as the **High Speed Printing** setting.

Disable quiet mode. This feature slows down the printing speed.

Windows

Disable the **Quiet Mode** setting on the printer driver's **Main** tab.

Mac OS X

Select **System Preferences** from the  menu > **Printers & Scanners** (or **Print & Scan, Print & Fax**), and then select the printer. Click **Options & Supplies** > **Options** (or **Driver**). Select **Off** as the **Quiet Mode** setting.

Cannot Start Scanning

Connect the interface cable securely to the printer and the computer.

If you are using a USB hub, try to connect the printer directly to the computer.

Solving Problems

- ❑ When using the printer on a network, make sure the printer is connected to the network properly. You can check the connection status from the network icon on the printer window and by printing a network status sheet. If the printer is not connected to the network, see the *Network Guide*.
- ❑ Make sure you select the correct printer (scanner) if a scanner list is displayed when you start EPSON Scan.
- ❑ If you are using any TWAIN-compliant applications, select the printer (scanner) you are using.
- ❑ In Windows, make sure the printer (scanner) is displayed in **Scanner and Camera**. The printer (scanner) should be displayed as "EPSON XXXXX (printer name)". If the printer (scanner) is not displayed, uninstall and then re-install EPSON Scan. See the following to access **Scanner and Camera**.
 - ❑ Windows 8.1/Windows 8
Select **Desktop > Settings > Control Panel**, enter "Scanner and Camera" in the search charm, click **Show Scanner and Camera**, and then check if the printer is displayed.
 - ❑ Windows 7
Click the start button and select **Control Panel**, enter "Scanner and Camera" in the search charm, click **View scanners and cameras**, and then check if the printer is displayed.
 - ❑ Windows Vista
Click the start button, select **Control Panel > Hardware and Sound > Scanners and Cameras**, and then check if the printer is displayed.
 - ❑ Windows XP
Click the start button, select **Control Panel > Printers and Other Hardware > Scanner and Cameras**, and then check if the printer is displayed.
- ❑ If you cannot scan using any TWAIN-compliant applications, uninstall and then reinstall the TWAIN compliant application.
- ❑ For Mac OS X with an Intel processor, if other Epson scanner drivers except for EPSON Scan, such as Rosetta or PPC are installed, uninstall them and EPSON Scan, and then reinstall EPSON Scan.

Related Information

- ➔ ["Uninstalling Applications" on page 78](#)
- ➔ ["Installing Applications" on page 79](#)

Cannot Start Scanning when Using the Control Panel

- ❑ Make sure EPSON Scan and Epson Event Manager are installed correctly.
- ❑ Check the scanning setting assigned in Epson Event Manager.

Related Information

- ➔ ["Cannot Start Scanning" on page 91](#)

Scanned Image Problems

Scan Quality Is Poor

- ❑ Clean the scanner glass and the document cover.

Solving Problems

- Do not press too hard on the original or the document cover when you are placing the originals on the scanner glass. Uneven colors, smears, or dots may appear when the original or the document cover are pressed too hard.
- Remove dust from the original.
- Scan at a higher resolution.
- Adjust the image in EPSON Scan, and then scan. See the EPSON Scan help for details.

Related Information

- ➔ [“Cleaning the Scanner Glass” on page 67](#)

Characters Are Blurred

- In **Home Mode** or **Office Mode** in EPSON Scan, select **Image Option** as the **Image Adjustments** setting, and then select **Text Enhancement**.
- In **Professional Mode** in EPSON Scan, select **Document** as the **Auto Exposure Type** in the **Original** settings.
- Adjust the threshold settings in EPSON Scan.
 - Home Mode**
Select **Black & White** as the **Image Type** setting, click **Brightness**, and then adjust the threshold.
 - Office Mode**
Select **Black & White** as the **Image Type** setting, and then adjust the threshold.
 - Professional Mode**
Select **Black & White** as the **Image Type** setting, and then adjust the threshold setting.
- Scan at a higher resolution.

An Image of the Reverse Side of the Original Appears in the Scanned Image

- For a thin original, place the original on the scanner glass and then place a piece of black paper over it.
- Make the appropriate document type settings in EPSON Scan.
- In **Home** or **Office Mode** in EPSON Scan, select **Image Option** as the **Image Adjustments** setting, and then select **Text Enhancement**.

Moire (Cross-Hatch) Patterns Appear in the Scanned Image

- Place the original at a slightly different angle.
- Select **Descreening** in any mode other than **Full Auto Mode** in EPSON Scan.
- Change the resolution setting in EPSON Scan.

Scanning Area or Direction Is Not Correct

- When placing the originals on the scanner glass, align the corner of the original with the corner indicated by a symbol on the frame of the scanner glass. If the edges of the scanned image are cropped off, move the original slightly away from the corner.

Solving Problems

- ❑ Clean the scanner glass and the document cover. If there is dust or stains on the glass, the scanning area may extend to include the dust or stains, resulting in the wrong scanning position or small images.
- ❑ When you place multiple originals on the scanner glass to scan them separately, but they are scanned onto a single file, place the originals at least 20 mm (0.8 inch) apart. If the problem continues, place one original at a time.
- ❑ When scanning using **Full Auto Mode** or the thumbnail preview in EPSON Scan, move the original 4.5 mm (0.18 inch) away from the edges of the scanner glass.
- ❑ When using the thumbnail preview for a large original in **Home Mode** or **Professional Mode** in EPSON Scan, the scanning area may not be correct. When previewing in EPSON Scan, create marquees of the area you want to scan on the **Preview** tab in the **Preview** window.
- ❑ If **Auto Photo Orientation** in EPSON Scan does not work as intended, see the EPSON Scan help.
- ❑ Clear **Auto Photo Orientation** in EPSON Scan.
- ❑ When scanning with EPSON Scan the available scanning area may be restricted if the resolution setting is too high. Lower the resolution or adjust the scanning area in the **Preview** window.

Related Information

- ➔ [“Placing Originals on the Scanner Glass” on page 22](#)
- ➔ [“Cleaning the Scanner Glass” on page 67](#)

The Scanned Image Problem Could Not be Cleared

If you have tried all of the solutions and could not solve the problem, click **Configuration** in a mode other than **Full Auto Mode** in the EPSON Scan window, and then click **Reset All** on the **Other** tab to initialize the EPSON Scan settings. If initialization does not solve the problem uninstall and re-install EPSON Scan.

Related Information

- ➔ [“Uninstalling Applications” on page 78](#)
- ➔ [“Installing Applications” on page 79](#)

Other Scanning Problems

Cannot Scan in Full Auto Mode in EPSON Scan

- ❑ You cannot scan to PDF/Multi-TIFF format continuously in **Full Auto Mode**. Scan in a mode other than **Full Auto Mode**.
- ❑ See the EPSON Scan help for other way of solving problems.

Thumbnail Preview Does Not Work Properly

See the EPSON Scan help.

Scanning Is Too Slow

Lower the resolution.

Scanning Stops when Scanning to PDF/Multi-TIFF

- When scanning large volumes, we recommend scanning in grayscale.
- Increase the free space on the computer's hard disk. Scanning may stop if there is not enough free space.
- Try scanning at a lower resolution. Scanning stops if the total data size reaches the limit.

Other Problems

Slight Electric Shock when Touching the Printer

If many peripherals are connected to the computer, you may feel a slight electric shock when touching the printer. Install a ground wire to the computer that is connected to the printer.

Operation Sounds Are Loud

If operations sounds are too loud, enable quiet mode. However, this may slow down printer operations.

Windows

Enable **Quiet Mode** on the **Main** tab in the printer driver.

Mac OS X

Select **System Preferences** from the  menu > **Printers & Scanners** (or **Print & Scan, Print & Fax**), and then select the printer. Click **Options & Supplies** > **Options** (or **Driver**). Select **On** as the **Quiet Mode** setting.

Quiet Mode is only effective when you select **plain papers** as the **Media Type** setting and **Normal** as the **Print Quality** setting in the **Print Settings** menu.

EPSON Scan

Select a mode other than **Full Auto Mode**, click **Configuration**, and then set **Quiet Mode** on the **Other** tab.

Application Is Blocked by a Firewall (for Windows Only)

Add the application to the Windows Firewall allowed program in security settings on the **Control Panel**.

Appendix

Technical Specifications

Printer Specifications

Print Head Nozzle Placement		Black ink nozzles: 128 row Color ink nozzles: 42 rows for each color
Weight of Paper	Plain Paper	64 to 90 g/m ² (17 to 24lb)
	Envelopes	Envelope #10, DL, C6: 75 to 90 g/m ² (20 to 24 lb)

Printable Area

Print quality may decline in the shaded areas due to the printer's mechanism.

Single sheets (normal printing)

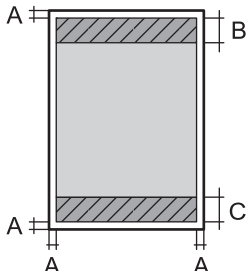
	A	3.0 mm (0.12 in.)
	B	40.0 mm (1.60 in.)
	C	34.0 mm (1.34 in.)

Single sheets (borderless printing)

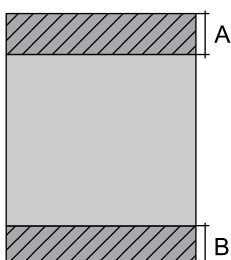
	A	43.0 mm (1.72 in.)
	B	37.0 mm (1.46 in.)

Appendix

Envelopes

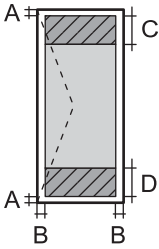
	A	3.0 mm (0.12 in.)
	B	5.0 mm (0.20 in.)
	C	18.0 mm (0.71 in.)
	D	40.0 mm (1.60 in.)

Scanner Specifications

Scanner Type	Flatbed
Photoelectric Device	CIS
Maximum Document Size	216 × 297 mm (8.5 × 11.7 in.) A4, Letter
Resolution	1200 dpi (main scan) 2400 dpi (sub scan)
Color Depth	<p>Color</p> <ul style="list-style-type: none"> <input type="checkbox"/> 48 bits per pixel internal (16 bits per pixel per color internal) <input type="checkbox"/> 24 bits per pixel external (8 bits per pixel per color external) <p>Grayscale</p> <ul style="list-style-type: none"> <input type="checkbox"/> 16 bits per pixel internal <input type="checkbox"/> 8 bits per pixel external <p>Black and white</p> <ul style="list-style-type: none"> <input type="checkbox"/> 16 bits per pixel internal <input type="checkbox"/> 1 bits per pixel external
Light Source	LED

Interface Specifications

For Computer	Hi-Speed USB
--------------	--------------

Wi-Fi Specifications

Standards	IEEE802.11b/g/n
Frequency Range	2.4 GHz
Coordination Modes	Infrastructure, Ad hoc ^{1*}
Wireless Securities	WEP (64/128bit), WPA2-PSK (AES) ^{*2}

Appendix

*1 Not supported for IEEE 802.11n.

*2 Complies with WPA2 standards with support for WPA/WPA2 Personal.

Security Protocol

SSL/TLS	HTTPS Client
---------	--------------

Dimensions

Dimensions	<p>Storage</p> <ul style="list-style-type: none"> <input type="checkbox"/> Width: 390 mm (15.4 in.) <input type="checkbox"/> Depth: 300 mm (11.8 in.) <input type="checkbox"/> Height: 145 mm (5.7 in.) <p>Printing</p> <ul style="list-style-type: none"> <input type="checkbox"/> Width: 390 mm (15.4 in.) <input type="checkbox"/> Depth: 504 mm (19.8 in.) <input type="checkbox"/> Height: 279 mm (11.0 in.)
Weight*	Approx. 3.9 kg (8.6 lb)

* Without the ink cartridges and the power cord.

Electrical Specifications

Model	100 to 240 V Model	220 to 240 V Model
Rated Frequency Range	50 to 60 Hz	50 to 60 Hz
Rated Current	0.5 to 0.3 A	0.3 A
Power Consumption (with USB Connection)	<p>Standalone copying: Approx. 11 W (ISO/IEC24712)</p> <p>Ready mode: Approx. 4.2 W</p> <p>Sleep mode: Approx. 1.6 W</p> <p>Power off: Approx. 0.3 W</p>	<p>Standalone copying: Approx. 11 W (ISO/IEC24712)</p> <p>Ready mode: Approx. 4.2 W</p> <p>Sleep mode: Approx. 1.6 W</p> <p>Power off: Approx. 0.3 W</p>

Note:

- Check the label on the printer for its voltage.
- For users in Belgium, power consumption when copying may vary.
Check <http://www.epson.be> for the latest specifications.

Appendix

Environmental Specifications

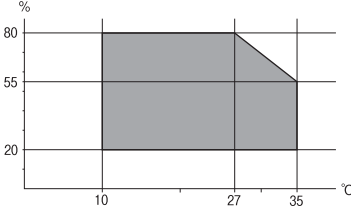
Operation	<p>Use the printer within the range shown in the following graph.</p>  <p>Temperature: 10 to 35°C (50 to 95°F) Humidity: 20 to 80% RH (without condensation)</p>
Storage	<p>Temperature: -20 to 40°C (-4 to 104°F)* Humidity: 5 to 85% RH (without condensation)</p>

* You can store for one month at 40°C (104°F).

Environmental Specifications for Ink Cartridges

Storage Temperature	-20 to 40 °C (-4 to 104 °F)*
Freezing Temperature	<p>-16 °C (3.2 °F) Ink thaws and is usable after approximately 3 hours at 25 °C (77 °F).</p>

* You can store for one month at 40 °C (104 °F).

System Requirements

- Windows 8.1 (32-bit, 64-bit)/Windows 8 (32-bit, 64-bit)/Windows 7 (32-bit, 64-bit)/Windows Vista (32-bit, 64-bit)/Windows XP Professional x64 Edition/Windows XP (32-bit)
- Mac OS X v10.9.x/Mac OS X v10.8.x/Mac OS X v10.7.x/Mac OS X v10.6.8

Note:

- Mac OS X may not support some applications and features.*
- The UNIX File System (UFS) for Mac OS X is not supported.*

Regulatory Information

Standards and Approvals

Standards and Approvals for U.S. Model

Safety	<p>UL60950-1 CAN/CSA-C22.2 No.60950-1</p>
--------	---

Appendix

EMC	FCC Part 15 Subpart B Class B CAN/CSA-CEI/IEC CISPR 22 Class B
-----	---

This equipment contains the following wireless module.

Manufacturer: Askey Computer Corporation

Type: WLU6320-D69 (RoHS)

This product conforms to Part 15 of the FCC Rules and RSS-210 of the IC Rules. Epson cannot accept responsibility for any failure to satisfy the protection requirements resulting from a non-recommended modification of the product. Operation is subject to the following two conditions: (1) this device may not cause harmful interference, and (2) this device must accept any interference received, including interference that may cause undesired operation of the device.

To prevent radio interference to the licensed service, this device is intended to be operated indoors and away from windows to provide maximum shielding. Equipment (or its transmit antenna) that is installed outdoors is subject to licensing.

Standards and Approvals for European Model

Low voltage directive 2006/95/EC	EN60950-1
EMC directive 2004/108/EC	EN55022 Class B EN61000-3-2 EN61000-3-3 EN55024
R&TTE directive 1999/5/EC	EN300 328 EN301 489-1 EN301 489-17 EN60950-1

For European users

We, Seiko Epson Corporation, hereby declare that the following equipment Models are in compliance with the essential requirements and other relevant provisions of Directive 1999/5/EC:

C462Q

For use only in Ireland, UK, Austria, Germany, Liechtenstein, Switzerland, France, Belgium, Luxemburg, Netherlands, Italy, Portugal, Spain, Denmark, Finland, Norway, Sweden, Iceland, Croatia, Cyprus, Greece, Slovenia, Malta, Bulgaria, Czech, Estonia, Hungary, Latvia, Lithuania, Poland, Romania, and Slovakia.

Epson cannot accept responsibility for any failure to satisfy the protection requirements resulting from a non-recommended modification of the products.



Standards and Approvals for Australian Model

EMC	AS/NZS CISPR22 Class B
-----	------------------------

Appendix

Epson hereby declares that the following equipment Models are in compliance with the essential requirements and other relevant provisions of AS/NZS4268:

C462Q

Epson cannot accept responsibility for any failure to satisfy the protection requirements resulting from a non-recommended modification of the products.

Restrictions on Copying

Observe the following restrictions to ensure the responsible and legal use of the printer.

Copying of the following items is prohibited by law:

- Bank bills, coins, government-issued marketable securities, government bond securities, and municipal securities
- Unused postage stamps, pre-stamped postcards, and other official postal items bearing valid postage
- Government-issued revenue stamps, and securities issued according to legal procedure

Exercise caution when copying the following items:

- Private marketable securities (stock certificates, negotiable notes, checks, etc.), monthly passes, concession tickets, etc.
- Passports, driver's licenses, warrants of fitness, road passes, food stamps, tickets, etc.

Note:

Copying these items may also be prohibited by law.

Responsible use of copyrighted materials:

Printers can be misused by improperly copying copyrighted materials. Unless acting on the advice of a knowledgeable attorney, be responsible and respectful by obtaining the permission of the copyright holder before copying published material.

Saving Power

The printer enters sleep mode or turns off automatically if no operations are performed for a set period. You can adjust the time before power management is applied. Any increase will affect the printer's energy efficiency. Please consider the environment before making any change.

Saving Power - Windows

1. Access the printer driver window.
2. Click **Printer and Option Information** on the **Maintenance** tab.
3. Select the time period before the printer enters sleep mode as the **Sleep Timer** setting, and click **Send**. To make the printer turn off automatically, select the time period as the **Power Off Timer** setting, and click **Send**.
4. Click **OK**.

Saving Power - Mac OS X

1. Select **System Preferences** from the  menu > **Printers & Scanners** (or **Print & Scan, Print & Fax**), and then select the printer.
2. Click **Options & Supplies** > **Utility** > **Open Printer Utility**.
3. Click **Printer Settings**.
4. Select the time period before the printer enters sleep mode as the **Sleep Timer** setting, and click **Apply**. To make the printer turn off automatically, select the time period as the **Power Off Timer** setting, and click **Apply**.

Transporting the Printer

When you need to transport the printer to move or for repairs, follow the steps below to pack the printer.

 **Important:**

- When storing or transporting the printer, avoid tilting it, placing it vertically, or turning it upside down; otherwise ink may leak.
- Leave the ink cartridges installed. Removing the cartridges can dry out the print head and may prevent the printer from printing.

1. Turn off the printer by pressing the  button.
2. Make sure the power light turns off, and then unplug the power cord.

 **Important:**

Unplug the power cord when the power light is off. Otherwise, the print head does not return to the home position causing the ink to dry, and printing may become impossible.

3. Disconnect all cables such as the power cord and USB cable.
4. Remove all of the paper from the printer.
5. Make sure there are no originals on the printer.

Appendix

6. Open the scanner unit with the document cover closed. Secure the ink cartridge holder to the case with tape.

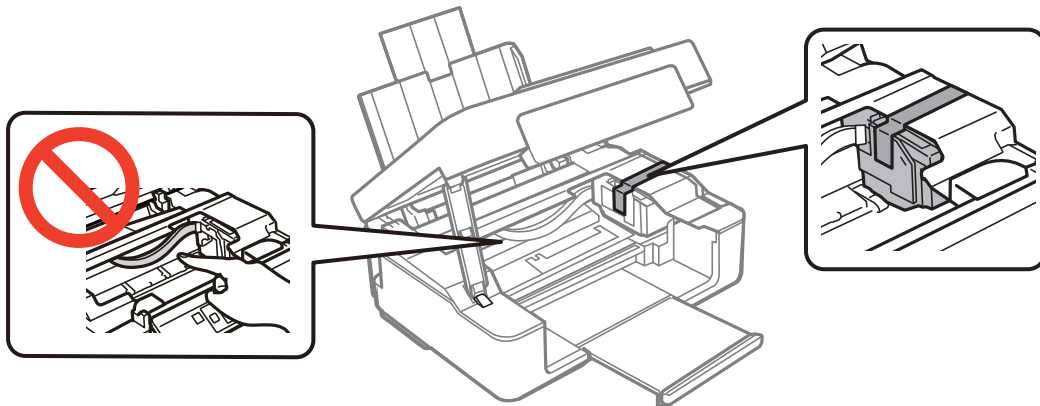

7. Close the scanner unit.

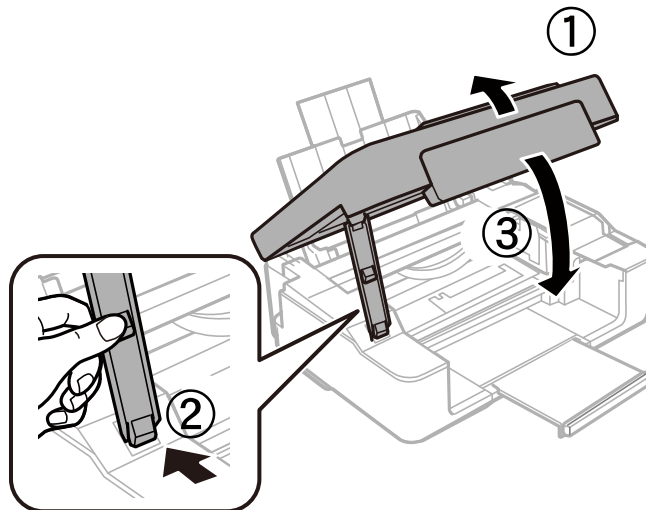

8. Prepare to pack the printer as shown below.

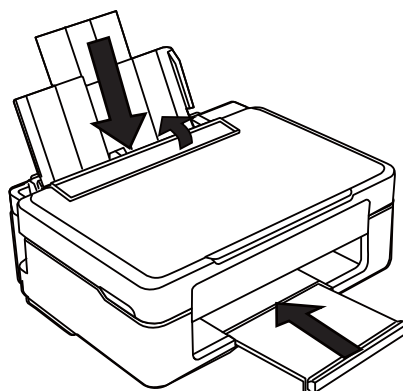

9. Pack the printer in its box, using the protective materials.

Appendix

When you use the printer again, make sure you remove the tape securing the ink cartridge holder. If print quality has declined the next time you print, clean and align the print head.

Related Information

- ➔ “Part Names and Functions” on page 12
- ➔ “Checking and Cleaning the Print Head - Printer Buttons” on page 64
- ➔ “Aligning the Print Head” on page 66

Where to Get Help

Technical Support Web Site

If you need further help, visit the Epson support website shown below. Select your country or region and go to the support section of your local Epson website. The latest drivers, FAQs, manuals, or other downloadables are also available from the site.

<http://support.epson.net/>

<http://www.epson.eu/Support> (Europe)

If your Epson product is not operating properly and you cannot solve the problem, contact Epson support services for assistance.

Contacting Epson Support

Before Contacting Epson

If your Epson product is not operating properly and you cannot solve the problem using the troubleshooting information in your product manuals, contact Epson support services for assistance. If Epson support for your area is not listed below, contact the dealer where you purchased your product.

Epson support will be able to help you much more quickly if you give them the following information:

- Product serial number
(The serial number label is usually on the back of the product.)
- Product model
- Product software version
(Click **About**, **Version Info**, or a similar button in the product software.)
- Brand and model of your computer
- Your computer operating system name and version
- Names and versions of the software applications you normally use with your product

Note:

Depending on the product, the dial list data for fax and/or network settings may be stored in the product's memory. Due to breakdown or repair of a product, data and/or settings may be lost. Epson shall not be responsible for the loss of any data, for backing up or recovering data and/or settings even during a warranty period. We recommend that you make your own backup data or take notes.

Appendix

Help for Users in Europe

Check your Pan-European Warranty Document for information on how to contact Epson support.

Help for Users in Taiwan

Contacts for information, support, and services are:

World Wide Web

<http://www.epson.com.tw>

Information on product specifications, drivers for download, and products enquiry are available.

Epson HelpDesk (Phone: +02-80242008)

Our HelpDesk team can help you with the following over the phone:

- Sales enquiries and product information
- Product usage questions or problems
- Enquiries on repair service and warranty

Repair service center:

Telephone number	Fax number	Address
02-23416969	02-23417070	No.20, Beiping E. Rd., Zhongzheng Dist., Taipei City 100, Taiwan
02-27491234	02-27495955	1F., No.16, Sec. 5, Nanjing E. Rd., Songshan Dist., Taipei City 105, Taiwan
02-32340688	02-32340699	No.1, Ln. 359, Sec. 2, Zhongshan Rd., Zhonghe City, Taipei County 235, Taiwan
039-605007	039-600969	No.342-1, Guangrong Rd., Luodong Township, Yilan County 265, Taiwan
038-312966	038-312977	No.87, Guolian 2nd Rd., Hualien City, Hualien County 970, Taiwan
03-4393119	03-4396589	5F., No.2, Nandong Rd., Pingzhen City, Taoyuan County 32455, Taiwan
03-5325077	03-5320092	1F., No.9, Ln. 379, Sec. 1, Jingguo Rd., North Dist., Hsinchu City 300, Taiwan
04-23011502	04-23011503	3F., No.30, Dahe Rd., West Dist., Taichung City 40341, Taiwan
04-2338-0879	04-2338-6639	No.209, Xinxing Rd., Wuri Dist., Taichung City 414, Taiwan
05-2784222	05-2784555	No.463, Zhongxiao Rd., East Dist., Chiayi City 600, Taiwan
06-2221666	06-2112555	No.141, Gongyuan N. Rd., North Dist., Tainan City 704, Taiwan
07-5520918	07-5540926	1F., No.337, Minghua Rd., Gushan Dist., Kaohsiung City 804, Taiwan
07-3222445	07-3218085	No.51, Shandong St., Sanmin Dist., Kaohsiung City 807, Taiwan
08-7344771	08-7344802	1F., No.113, Shengli Rd., Pingtung City, Pingtung County 900, Taiwan

Help for Users in Australia

Epson Australia wishes to provide you with a high level of customer service. In addition to your product manuals, we provide the following sources for obtaining information:

Internet URL

<http://www.epson.com.au>

Access the Epson Australia World Wide Web pages. Worth taking your modem here for the occasional surf! The site provides a download area for drivers, Epson contact points, new product information and technical support (e-mail).

Epson Helpdesk

Epson Helpdesk is provided as a final backup to make sure our clients have access to advice. Operators on the Helpdesk can aid you in installing, configuring and operating your Epson product. Our Pre-sales Helpdesk staff can provide literature on new Epson products and advise where the nearest dealer or service agent is located. Many types of queries are answered here.

The Helpdesk numbers are:

Phone: 1300 361 054

We encourage you to have all the relevant information on hand when you ring. The more information you prepare, the faster we can help solve the problem. This information includes your Epson product manuals, type of computer, operating system, application programs, and any information you feel is required.

Help for Users in Singapore

Sources of information, support, and services available from Epson Singapore are:

World Wide Web

<http://www.epson.com.sg>

Information on product specifications, drivers for download, Frequently Asked Questions (FAQ), Sales Enquiries, and Technical Support via e-mail are available.

Epson HelpDesk (Phone: (65) 6586 3111)

Our HelpDesk team can help you with the following over the phone:

- Sales enquiries and product information
- Product usage questions or problems
- Enquiries on repair service and warranty

Help for Users in Hong Kong

To obtain technical support as well as other after-sales services, users are welcome to contact Epson Hong Kong Limited.

Internet Home Page

Epson Hong Kong has established a local home page in both Chinese and English on the Internet to provide users with the following information:

- Product information

Appendix

- Answers to Frequently Asked Questions (FAQs)
- Latest versions of Epson product drivers

Users can access our World Wide Web home page at:

<http://www.epson.com.hk>

Technical Support Hotline

You can also contact our technical staff at the following telephone and fax numbers:

Phone: (852) 2827-8911

Fax: (852) 2827-4383