



CORSAIR

iCUE

H100i | H115i | H150i | H170i
ELITE CAPELLIX XT

EXTREME PERFORMANCE LIQUID CPU COOLER

EN ENGLISH

FR FRANÇAIS (EURO)

DE DEUTSCH

NL NEDERLANDS

IT ITALIANO

ES ESPAÑOL (EURO)

PT PORTUGUÊS (EURO)

PL POLSKI

SC 简体中文

AR العربية



TABLE OF CONTENTS

INTEL (All Sockets)

AMD AM5/AM4

AMD sTRX4

FINISHING UP YOUR INSTALLATION



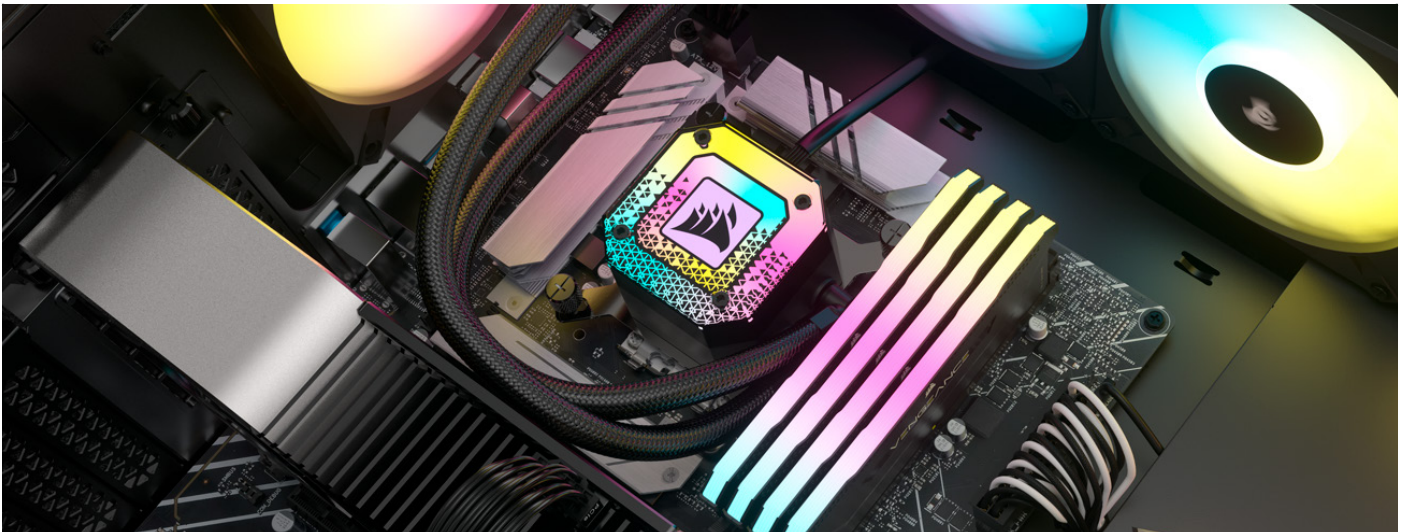







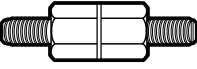

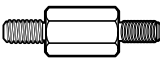
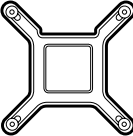
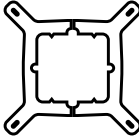
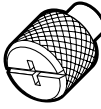
FAQ

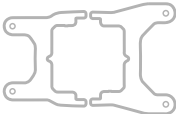

Note: Most newer PC cases include a CPU cut-out to allow access to the bottom of the motherboard. If your case does not include a cut-out, you will need to remove your motherboard from the case prior to installation. ELITE Series coolers come with the Intel mounting bracket pre-installed on the pump for quick installation.

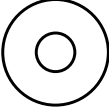
INCLUDED HARDWARE

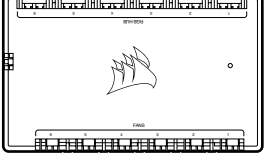
Highlighted parts for Intel installation only

<p>A</p>  <p>x4 INTEL 1200/1156/1155/1151/1150 STANDOFFS</p>	<p>B</p>  <p>x4 INTEL 2066/2011-3/2011 STANDOFFS</p>	<p>C</p>  <p>x4 INTEL 1700 STANDOFFS</p>
<p>D</p>  <p>x1 INTEL BACKPLATE (1200/115X/1700 ONLY)</p>	<p>E</p>  <p>x1 INTEL MOUNTING BRACKET (PRE-INSTALLED)</p>	<p>F</p>  <p>x4 THUMB NUTS</p>
<p>G</p>  <p>x4 AMD AM5/AM4 STANDOFFS</p>	<p>H</p>  <p>x1 AMD AM5/AM4 MOUNTING BRACKET</p>	<p>I</p>  <p>x1 AMD sTR4/sTRX4 MOUNTING BRACKET</p>
<p>J</p>  <p>x4 AMD sTR4/sTRX4 STANDOFFS</p>	<p>K</p>  <p>x16 LONG FAN SCREWS (H100i/H115i) x24 LONG FAN SCREWS (H150i/H170i)</p>	<p>L</p>  <p>x8 RADIATOR SCREWS (H100i/H115i) x12 RADIATOR SCREWS (H150i/H170i)</p>
<p>M</p>  <p>x8 WASHERS (H100i/H115i) x12 WASHERS (H150i/H170i)</p>	<p>N</p>  <p>x2 AF RGB ELITE FANS (H100i/H115i) x3 AF RGB ELITE FANS (H150i/H170i)</p>	<p>O</p>  <p>COMMANDER CORE</p>
<p>P</p>  <p>CAP REMOVAL TOOL</p>	<p>Q</p>  <p>x2 ALTERNATIVE PUMP CAP</p>	

1. INSTALLING THE INTEL BACKPLATE

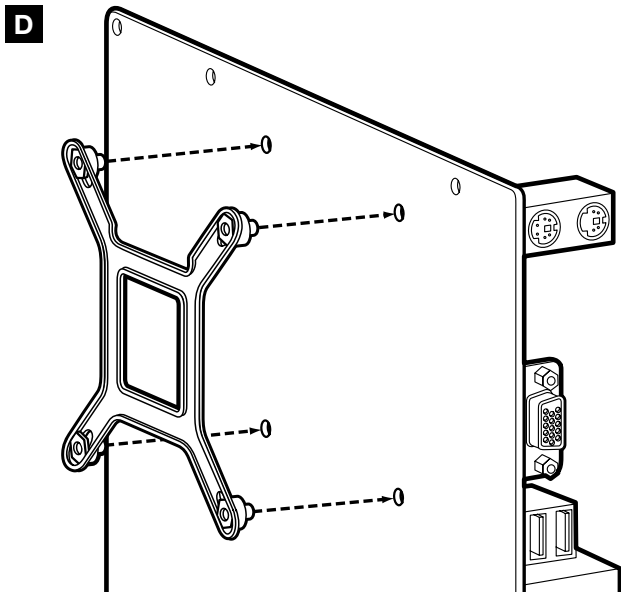

Adjust backplate for your required socket.

NOTE: Intel LGA 2066/2011-3/2011 do not require backplate installation. Proceed to step 2.

2. INSTALLING THE INTEL STANDOFF SCREWS

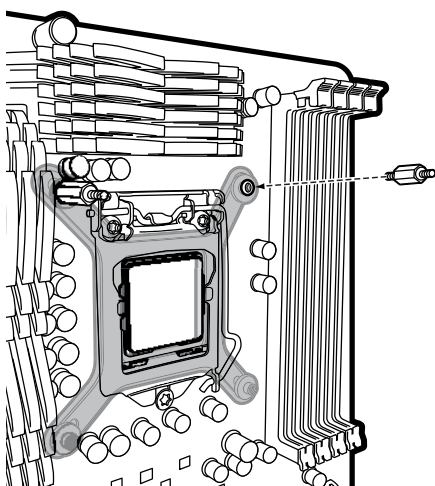

A LGA 1200/1150/
1151/1155/1156

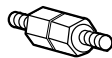

B LGA 2011/
2011-3/2066

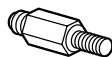

C LGA 1700

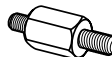

> Attach the provided Intel standoff for your socket.

> Use (A) for LGA 1200/115X, (B) for LGA 2011/2011-3/2066 or (C) for LGA 1700.

> Tighten all four standoffs until firmly secured.

3. INSTALL THE FANS AND RADIATOR

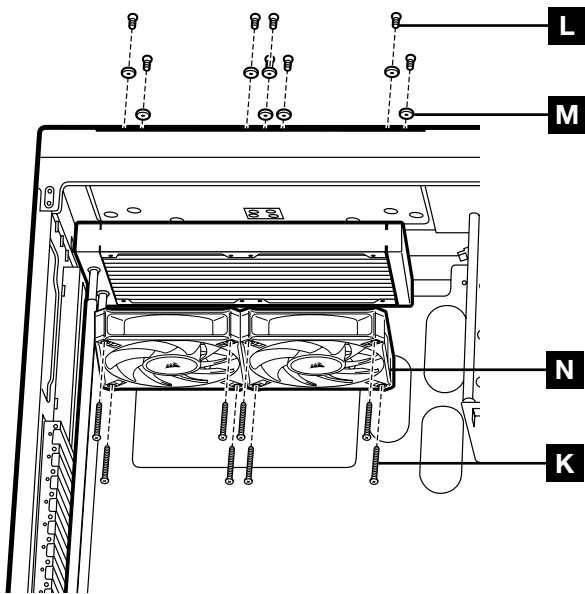

Attach the radiator and the fans as shown. For the best cooling performance, we recommend mounting the fans as an air-intake to your PC case.

4. INSTALLING THE PUMP UNIT

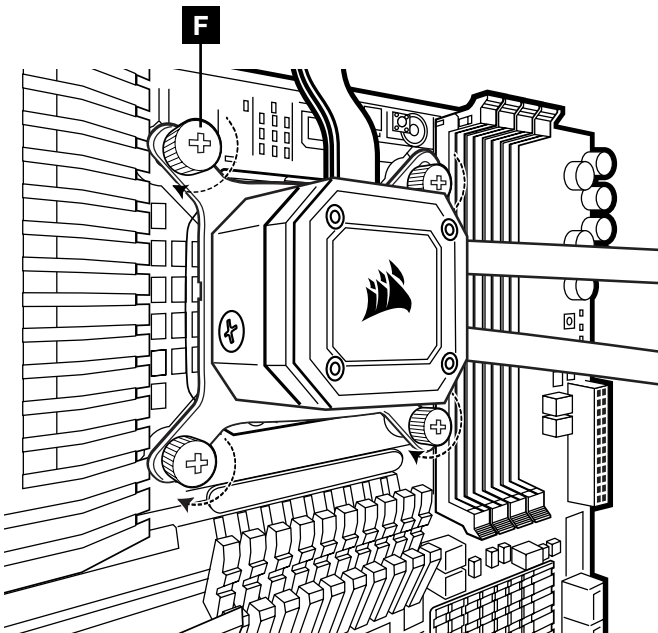









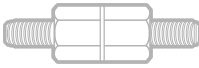

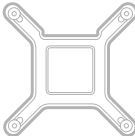
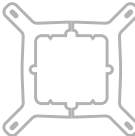
- > Align the bracket and pump over the standoff screws as shown.
- > Attach the thumb nuts (F) to the standoff screws as shown.
- > Tighten the thumb nuts until all four corners are firmly secured.

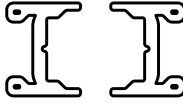
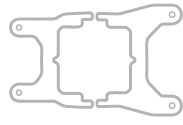
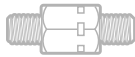
Please continue to Page 10 to continue your installation.

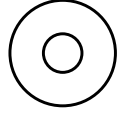
INCLUDED HARDWARE

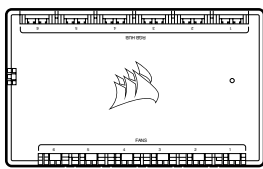
Highlighted parts for AMD AM5/AM4 installation only

<p>A</p>  <p>x4 INTEL 1200/1156/1155/1151/1150 STANDOFFS</p>	<p>B</p>  <p>x4 INTEL 2066/2011-3/2011 STANDOFFS</p>	<p>C</p>  <p>x4 INTEL 1700 STANDOFFS</p>
<p>D</p>  <p>x1 INTEL BACKPLATE (1200/115X/1700 ONLY)</p>	<p>E</p>  <p>x1 INTEL MOUNTING BRACKET (PRE-INSTALLED)</p>	<p>F</p>  <p>x4 THUMB NUTS</p>
<p>G</p>  <p>x4 AMD AM5/AM4 STANDOFFS</p>	<p>H</p>  <p>x1 AMD AM5/AM4 MOUNTING BRACKET</p>	<p>I</p>  <p>x1 AMD sTR4/sTRX4 MOUNTING BRACKET</p>
<p>J</p>  <p>x4 AMD sTR4/sTRX4 STANDOFFS</p>	<p>K</p>  <p>x16 LONG FAN SCREWS (H100i/H115i) x24 LONG FAN SCREWS (H150i/H170i)</p>	<p>L</p>  <p>x8 RADIATOR SCREWS (H100i/H115i) x12 RADIATOR SCREWS (H150i/H170i)</p>
<p>M</p>  <p>x8 WASHERS (H100i/H115i) x12 WASHERS (H150i/H170i)</p>	<p>N</p>  <p>x2 AF RGB ELITE FANS (H100i/H115i) x3 AF RGB ELITE FANS (H150i/H170i)</p>	<p>O</p>  <p>COMMANDER CORE</p>
<p>P</p>  <p>CAP REMOVAL TOOL</p>	<p>Q</p>  <p>x2 ALTERNATIVE PUMP CAP</p>	

1. INSTALLING THE AMD AM5/AM4 MOUNTING BRACKET

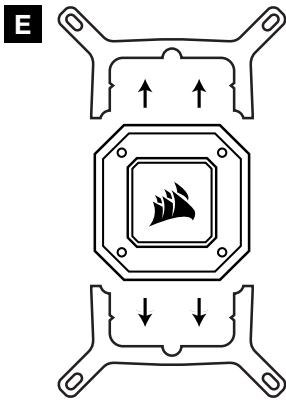

Figure 1

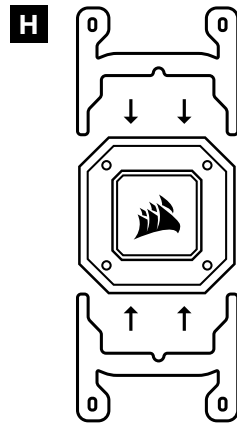
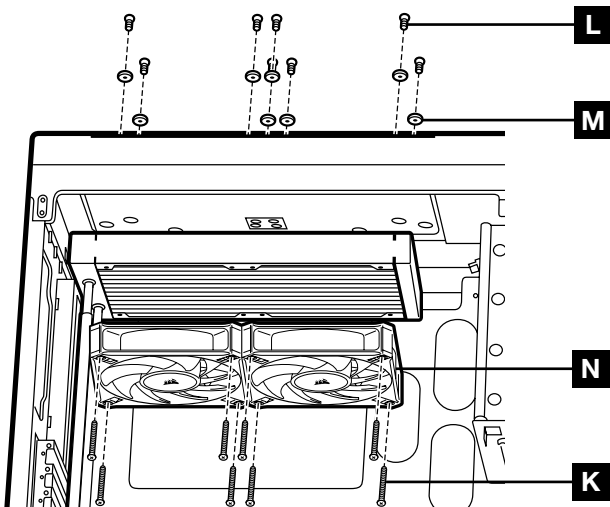

Figure 2

- > Remove the integrated Intel mounting bracket (Figure 1).
- > Install the AMD AM5/AM4 bracket by pushing both sides into the slot on the pump until secure (Figure 2).

Note: It is important that the AMD AM5/AM4 retention bracket be evenly secured on all sides before installation.

2. INSTALL THE FANS AND RADIATOR



Attach the radiator and the fans as shown. For the best cooling performance, we recommend mounting the fans as an air-intake to your PC case.

3. PREPARE THE MOTHERBOARD FOR INSTALLATION

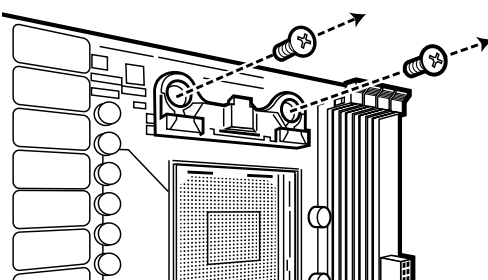

Remove the existing AMD AM5/AM4 mounting brackets shown.

4. INSTALLING THE AMD AM5/AM4 STANDOFF SCREWS

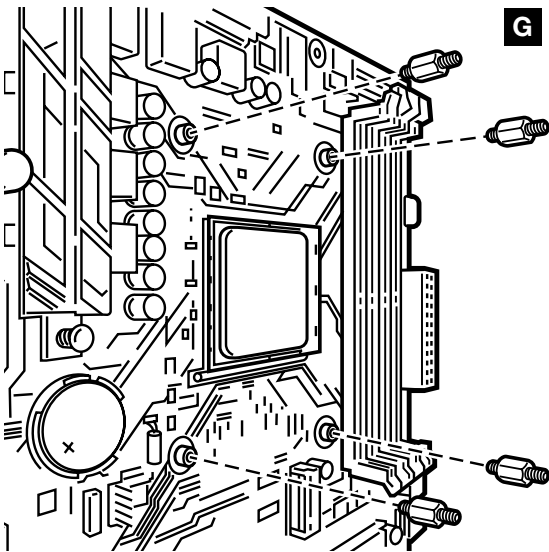

- > Attach the provided AMD AM5/AM4 standoffs to the CPU socket.
- > Tighten all four screws until firmly secure.

5. INSTALLING THE PUMP UNIT

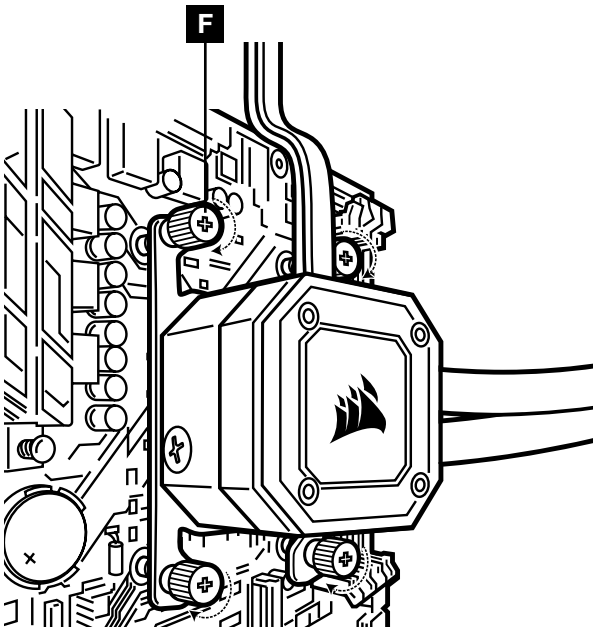









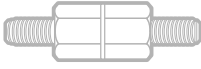

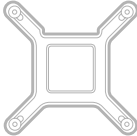
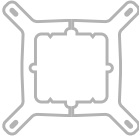
- Align the bracket with the AMD AM5/AM4 standoffs as shown. Tighten the thumb nuts (F) until secure.

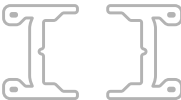
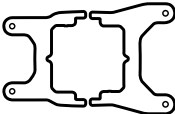
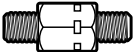
Please continue to Page 10 to continue your installation.

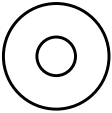
INCLUDED HARDWARE

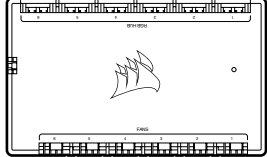
Highlighted parts for AMD sTRX4 installation only

<p>A</p>  <p>x4 INTEL 1200/1156/1155/1151/1150 STANDOFFS</p>	<p>B</p>  <p>x4 INTEL 2066/2011-3/2011 STANDOFFS</p>	<p>C</p>  <p>x4 INTEL 1700 STANDOFFS</p>
<p>D</p>  <p>x1 INTEL BACKPLATE (1200/115X/1700 ONLY)</p>	<p>E</p>  <p>x1 INTEL MOUNTING BRACKET (PRE-INSTALLED)</p>	<p>F</p>  <p>x4 THUMB NUTS</p>
<p>G</p>  <p>x4 AMD AM5/AM4 STANDOFFS</p>	<p>H</p>  <p>x1 AMD AM5/AM4 MOUNTING BRACKET</p>	<p>I</p>  <p>x1 AMD sTR4/sTRX4 MOUNTING BRACKET</p>
<p>J</p>  <p>x4 AMD sTR4/sTRX4 STANDOFFS</p>	<p>K</p>  <p>x16 LONG FAN SCREWS (H100i/H115i) x24 LONG FAN SCREWS (H150i/H170i)</p>	<p>L</p>  <p>x8 RADIATOR SCREWS (H100i/H115i) x12 RADIATOR SCREWS (H150i/H170i)</p>
<p>M</p>  <p>x8 WASHERS (H100i/H115i) x12 WASHERS (H150i/H170i)</p>	<p>N</p>  <p>x2 AF RGB ELITE FANS (H100i/H115i) x3 AF RGB ELITE FANS (H150i/H170i)</p>	<p>O</p>  <p>COMMANDER CORE</p>
<p>P</p>  <p>CAP REMOVAL TOOL</p>	<p>Q</p>  <p>x2 ALTERNATIVE PUMP CAP</p>	

1. INSTALLING THE AMD sTRX4 MOUNTING BRACKET

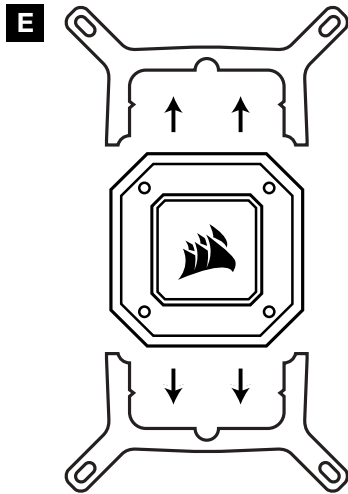

Figure 1

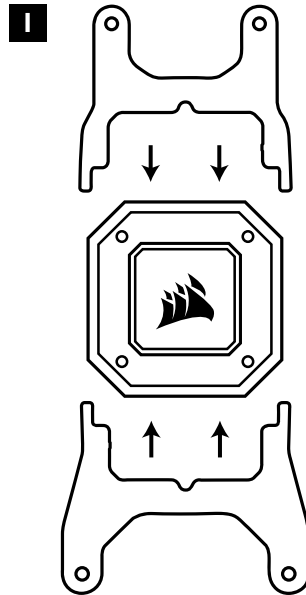
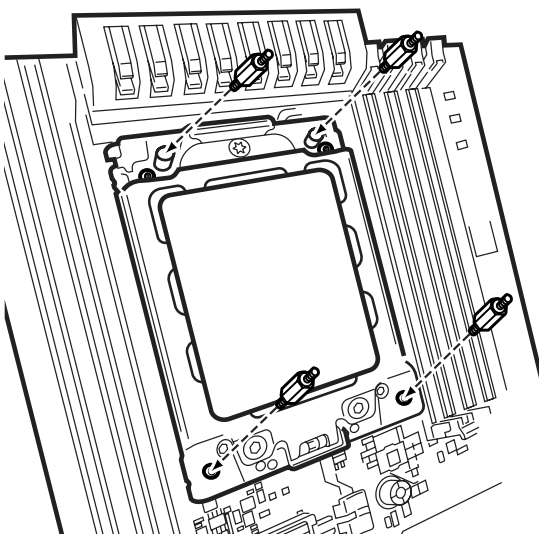

Figure 2

- > Remove the integrated Intel mounting bracket (Figure 1).
- > Install the AMD sTRX4 bracket by pushing both sides into the slot on the pump until secure (Figure 2).

Note: It is important that the AMD sTRX4 retention bracket be evenly secured on all sides before installation.

2. INSTALLING THE AMD sTRX4 STANDOFF SCREWS



- > Attach the provided AMD sTRX4 standoffs to the CPU socket.
- > Tighten all four standoff screws until firmly secure.

3. INSTALL THE FANS AND RADIATOR

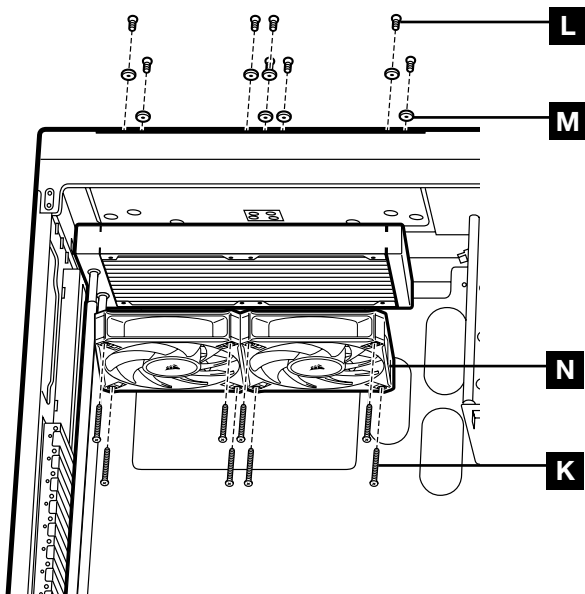

Attach the radiator and the fans as shown. For the best cooling performance, we recommend mounting the fans as an air-intake to your PC case.

4. INSTALLING THE PUMP UNIT

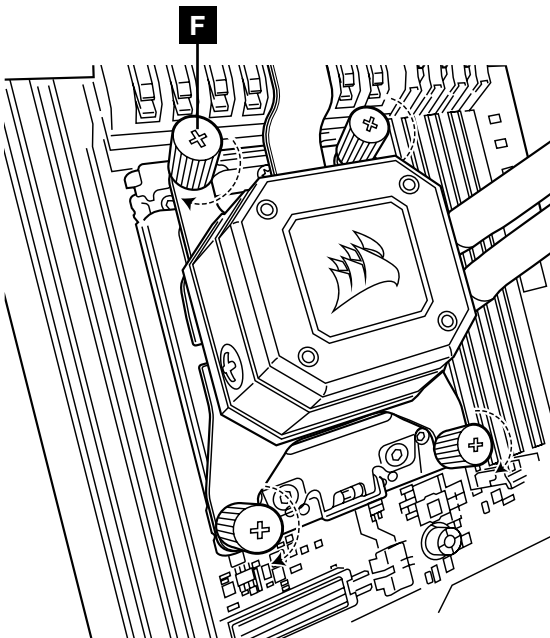

- > Align the bracket and pump over the standoff screws as shown.
- > Attach the thumb nuts (F) to the standoff screws as shown.
- > Tighten the thumb nuts until all four corners are firmly secured.

Please continue to Page 10 to continue your installation.

CONNECT FANS AND PUMP TO iCUE COMMANDER CORE

- > Connect pump 24-pin cable to your Commander CORE (Figure 1).
- > Connect pump tach cable to the CPU_FAN header on your motherboard (Figure 2).
- > Connect each fan to the Commander CORE (Figure 3).
- > Connect each fan RGB lead to the Commander CORE (Figure 3).

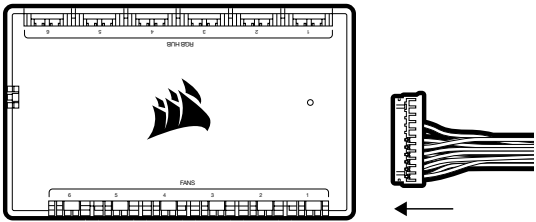

Figure 1

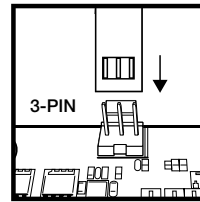

Figure 2

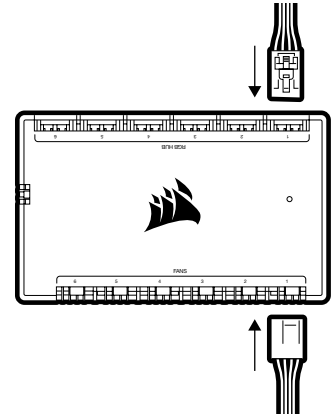
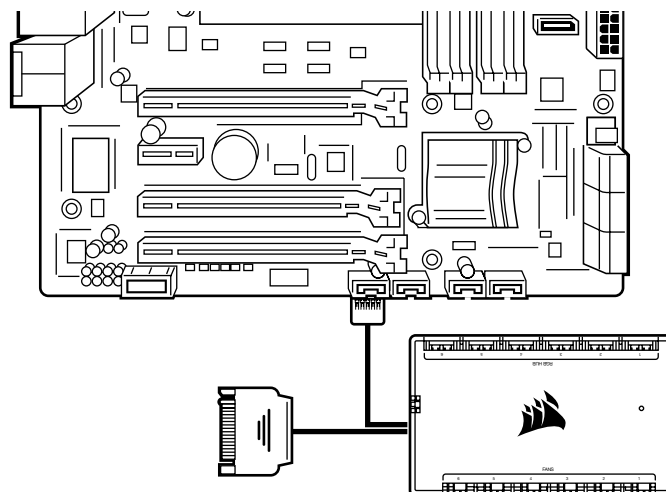

Figure 3

CONNECT COMMANDER CORE TO USB 2.0 HEADER AND POWER

- > Using the attached USB cable, connect the Commander CORE to a motherboard USB 2.0 header.
- > Connect pump power cable to an available SATA power plug from your power supply.



FAQ

1. How do I know the direction of the airflow of the fan?

An arrow located on the side of the fan indicates the direction of airflow.

2. Can I reuse the pre-applied thermal paste on the cooler for re-installation?

Re-installation of the cooler will require you to clean off the pre-applied thermal paste and re-apply the XTM70 thermal paste (sold separately).

3. What orientation should I install my radiator?

The best way to install a radiator is with the tubes on the bottom of the case, though you can install it with the tubes in any position, including an inverted radiator, as long as the highest point in the radiator is visibly higher than the CPU pump.

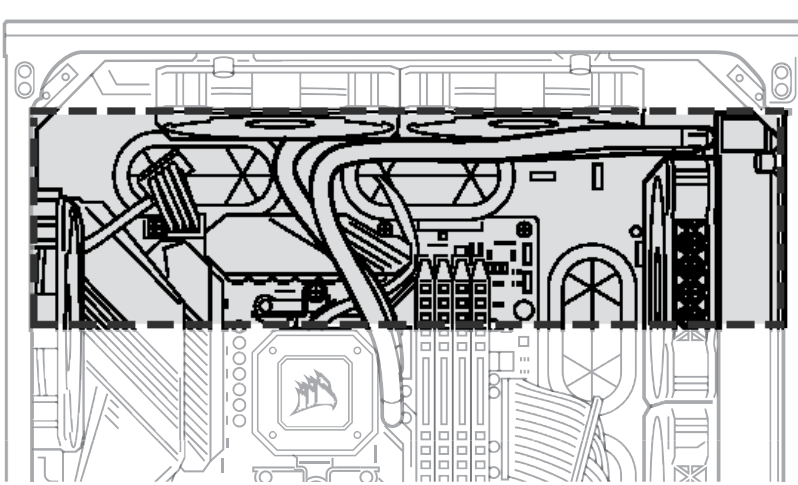

4. My cooler and fans are blinking red or not functioning. What do I do?

Please double check all connections between the cooler and fans. Ensure that the cooler is updated to the most recent firmware via iCUE. If this does not resolve your problems, please open a support ticket at support.corsair.com or contact our customer support team for further troubleshooting and assistance.

<https://help.corsair.com/hc/en-us/requests/new>



Web: corsair.com

Phone: (888) 222-4346

Warranty: corsair.com/support/warranty

Support: support.corsair.com

Blog: corsair.com/blog

Forum: forum.corsair.com

YouTube: youtube.com/corsairhowto

© 2023 **CORSAIR MEMORY, Inc.** All rights reserved. CORSAIR and the sails logo are registered trademarks of CORSAIR in the United States and/or other countries. All other trademarks are the property of their respective owners. Product may vary slightly from those pictured.

49-002642 AA



 **R-R-CSI-RWF0048**
R-R-CSI-RWF0077
R-R-CSI-RWF0085