



## vario2<sup>iP</sup> HYBRID

### Installation and Setup Guide

Installation by suitably trained and qualified personnel only  
Suitable for Internal and External Applications

**Box Contents:**

VARIO2 IPPOE Hybrid Illuminator - Infra-Red (IR) & White-Light (WL)  
35° x 10° beam angle IHD  
60° x 25° beam angle IHD  
Waterproof RJ45 connector

**Accessories (optional):**

80° x 30° beam angle IHD  
120° x 50° beam angle IHD

System requirements: PC running Windows 7 with IE9 (or equivalent) and network access.



## Safety Information

Install in a well ventilated area.

### Eye Safety : IR Light (850nm and 940nm)

Caution – IR emitted from this product EN62471 Risk Group 2. Do not stare at the lamp. Avoid exposure or use appropriate shielding / eye protection. Risk Group 2 for cornea / lens infrared hazard. Hazard distance is 2000mm.

### Eye Safety : White Light

Caution – EN62471 Risk Group 2 Classification - Possible hazardous optical radiation emitted from this product. May be harmful to eyes, do not stare at the lamp. Hazard distance is 1500mm.

### Eye Safety : EHV (Exposure Hazard value)

69.2% of RG2 limit at 200mm from the lamp

## Product Introduction

Vario2 IPPOE Hybrid is a Network Illuminator that uses the latest in Infra-Red and White Light LED technology in the same illuminator package. The Vario2 IPPOE Hybrid is designed to connect to a suitable network and is provided with an integrated Web Interface.

The Raytec Discovery Tool allows for easy identification and connection to the illuminator or you can connect directly to the illuminator via its IP address.

The illuminator has a CAT 5 cable for data connection, can be powered from PoE, and is supplied with a waterproof CAT 5 connector. The illuminator also has an auxiliary cable if low voltage 24V DC operation is preferred.

The Vario2 IPPOE Hybrid comes with a number of features that allow the user to change between the two wavelengths.

The illuminator has a photocell for automatic day/night switching and has an External Input (to act as a telemetry, trigger input, volt free or TTL) and an External Output (volt free output). It also benefits from Raytecs interchangeable lens system so that the correct angle of illumination can always be achieved easily.

The illuminator has Operator and Administrator log-in and access rights. The Operator has access to the Homepage and Diagnostic pages. The Administrator has access to all pages.

An API is available for programmers for integration within a VMS / BMS environment. The illuminator also has a HTTP API to control the illuminator via HTTP commands.

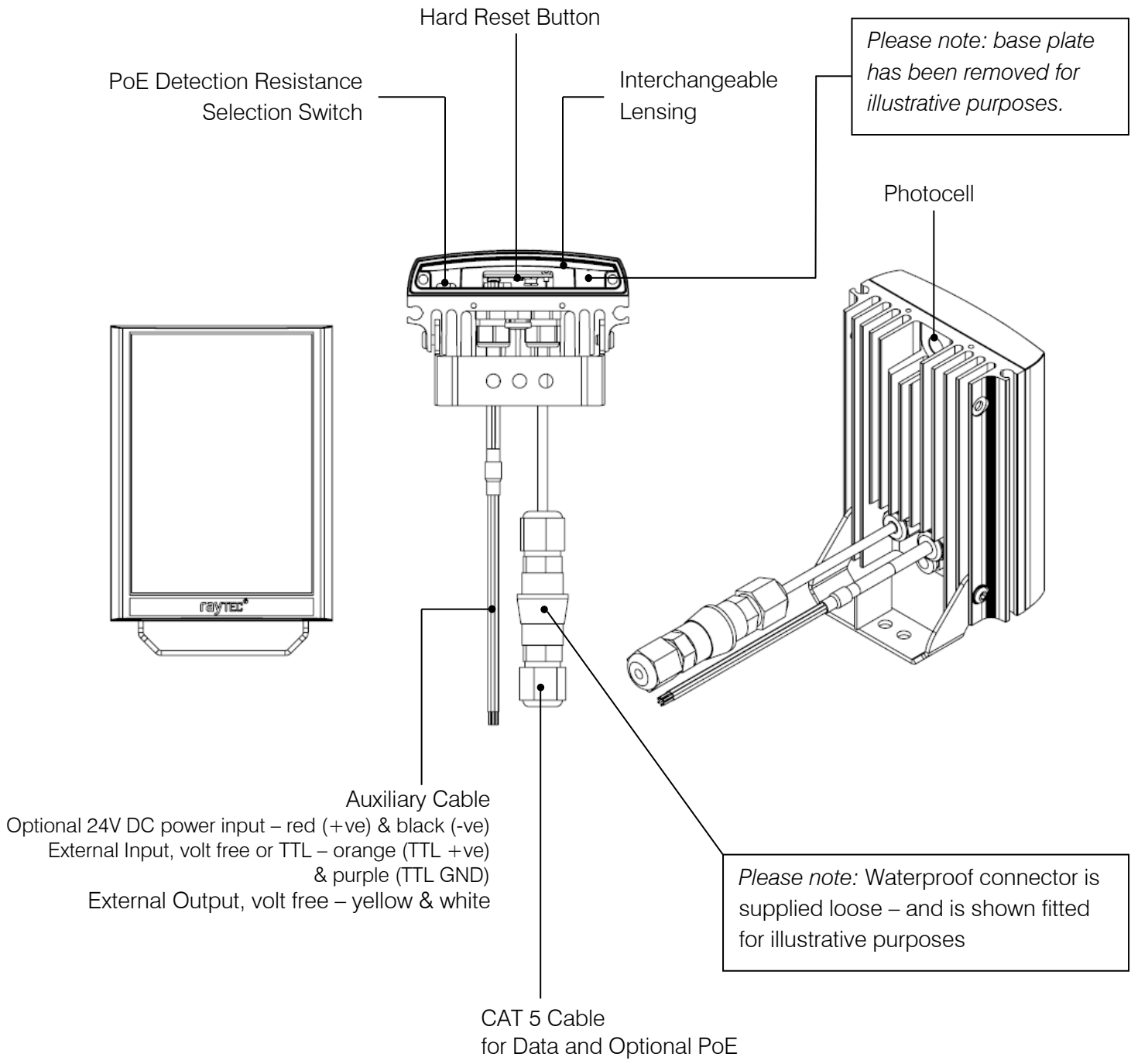

# Basic Steps

(Quick Installation Guide P1-19/ Detailed Guide – see Raytec website)

## **STEP 1: Safety Information (Pg. 2)**

## **STEP 2: Wiring (Pg. 7)**

For PoE, use standard CAT 5 or better for both power and data. For all 8 sized products, check the PoE detection resistance of the illuminator is compatible with your PoE equipment (24.9K $\Omega$  is factory default).

For low voltage (non-PoE) apply 24V DC to red and black cores of auxiliary cable and use standard CAT 5 or better for data connection. Connect external inputs and external output wires as required.

### **IMPORTANT:**

To choose between Infra-Red and White Light configure using the GUI interface

Default is IR for P/cell senses darkness and WL for Ext. Input if active when P/Cell senses darkness.

Ensure PoE equipment or 24V PSU are suitably rated

For 8 sized products check PoE detection resistance is set correctly

Ensure Cat 5 cable and auxiliary cable are correctly terminated and waterproofed after installation

If using low voltage, a CAT 5 cable must still be connected to the network for communication

If not using auxiliary cable, it must still be suitably terminated and waterproofed

## **STEP 3: Physical Installation (Pg. 9-10)**

Adjust interchangeable lens if required.

Fix to wall, pole or camera unit using U bracket provided or other Raytec bracketry.

### **IMPORTANT:**

Ensure illuminator is rated to provide required viewing distances and select correct angle

Ensure illuminator is orientated in the correct direction

#### **STEP 4: Change IP address and connect to the illuminator (Pg. 11)**

All Vario2 IPPOE Hybrids have the same default IP address and this must be changed immediately to avoid any potential conflicts or communication errors.

We recommend the easiest and fastest way to identify and connect to illuminators is using the Raytec Discovery Tool where the IP address can be altered or DHCP enabled.

Alternatively, type the IP address of illuminator into a web browser – default is 192.168.2.80 – and use the web interface to manually alter IP address.

#### **IMPORTANT:**

We recommend Raytec Discovery Tool as the easiest way to establish communication. If using IP address for direct communication, illuminator and computer must be in same network range.

#### **STEP 5: Illuminator Set-Up (Pg. 12-18)**

Raytec Discovery Tool Basics  
Log-in, Security & Basic Illuminator Setup  
Basic Web Page Functionality

#### **STEP 6: Basic Troubleshoot (Pg. 19)**

## Wiring

The illuminator is supplied with a terminated CAT 5 cable with a waterproof Ethernet connector (supplied loose i.e. not fitted) and an auxiliary multi-core cable.

### Option 1 – Power via PoE

Connect an Ethernet cable (category 5 or better) using the T-568B wiring standard between the Power Sourcing Equipment (PSE) and the illuminator. Ensure that the PSE is sufficiently rated to power the Vario2 IPPOE Hybrid device as follows:

Model	PoE Requirement
VAR2-IPPOE-hy4-1, hy4-1-C, hy6-1	IEEE 802.3at (HP PoE) $\geq 25.5W$
VAR2-IPPOE-hy8-1, hy8-1-C	4-pair PoE $\geq 51W$

The CAT5 cable is both the power and data connection for the illuminator. The maximum Ethernet cable length is 100m (328 ft) without boosting the signal.

Ensure you make a waterproof connection to the RJ45 as shown below. Ensure the connector is waterproof and sealed after the connection is made.



To illuminator

RJ45-RJ45 connector

To Network

### Option 2 – Power from 24V DC

If using low voltage power, connect **24V DC** to the red (+ve) and black (-ve) cables of the auxiliary cable. In this case the Ethernet cable is a data connection only.

For either Option 1 or Option 2 above, connect external input trigger and external output as required – see table below:

Colour	Description	Wire Gauge (AWG)
Orange	External Input -Volt free or TTL +ve	22
Purple	External Input -Volt free or TTL GND	22
Yellow	External Output – Volt free	22
White	External Output - Volt free	22

**WARNING:** To maintain the IP rating of the product the multi-core auxiliary cable must be waterproofed and terminated appropriately even if it is not in use.

## PoE Detection – Resistance Selection Switch

There is a switch on the VAR2-IPPOE-hy8-1 and hy8-1-C illuminators which can be used to change the PoE detection resistance of the illuminator (24.9K $\Omega$  is the factory default setting).

Turn the power to the illuminator OFF, remove the baseplate and access the switch as shown.

The majority of PSE equipment requires a detection resistance of 24.9K $\Omega$  to establish a PoE link. Some models of PSE equipment require a 12.5K $\Omega$  detection resistance. Check with your supplier of PSE equipment.

For 24.9 K $\Omega$ , slide switch to the LEFT (factory default – as shown). For 12.5 K $\Omega$ , slide switch to the RIGHT.

Detection Resistance Selection Switch

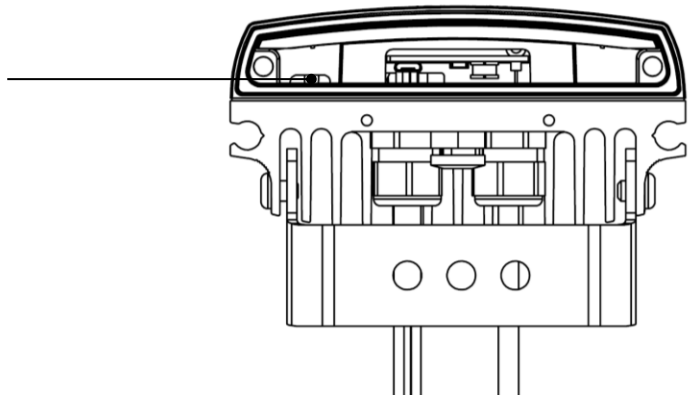



## Interchangeable Lenses: Changing the Angle

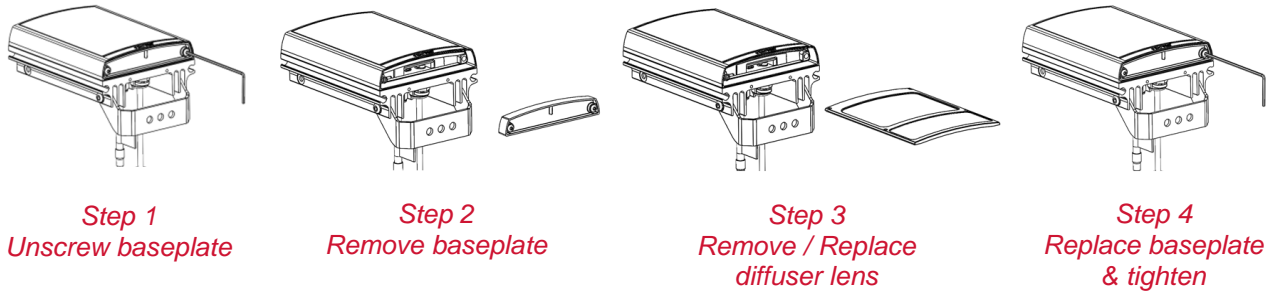

The illuminator is delivered with a 35° beam angle. To alter to 10°, remove the baseplate from the bottom of the product and remove the existing lens and then re-attach the baseplate securely. With no lens insert the product produces a 10° beam angle.

To alter to any other angle, remove the existing lens and insert the required lens which will have its angle indicated on it. Ensure the baseplate is securely re-attached to maintain waterproof integrity of the product.

The angles available as standard are: 10°x10° (NO lens / diffuser in place), 35°x10° and 60°x25°. Other angles are available to order: 80°x30° and 120°x50°.

## Installation

Vario2 IPPOE Hybrid is delivered as standard with a bracket at the bottom of the unit. This can be moved to the top of the unit if required.

Attach illuminator to wall, housing or pole using U-bracket provided or dedicated Raytec bracketry.

### Connect lamp to PSE and network.

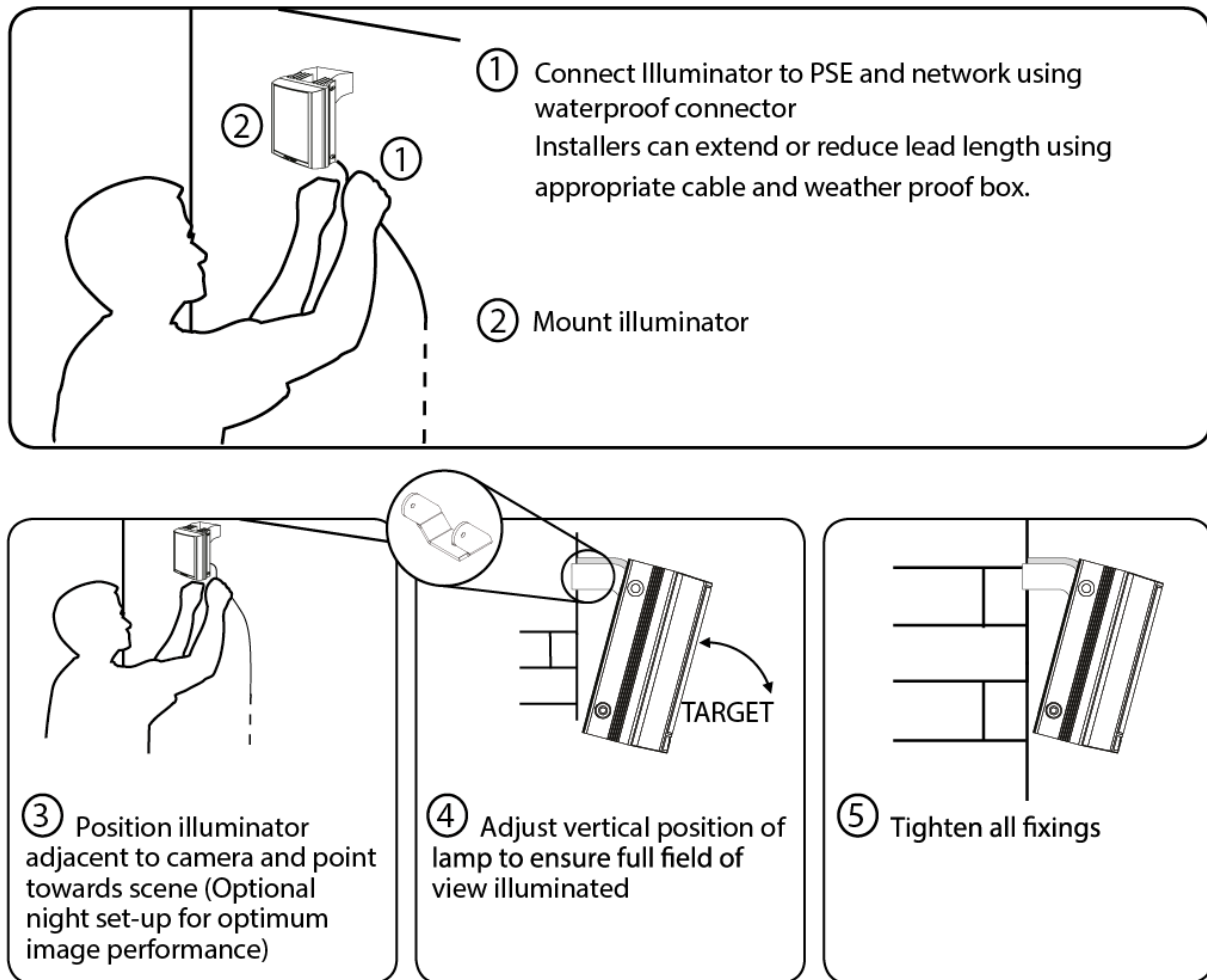

Notes :

Unit can alternatively be powered by 24V DC if required

Multi-core auxiliary cable also fitted to unit

- Use for alternative power (24V DC) if required
- Use for connecting external input and external output as required

To maintain the IP rating of the product, any cable not in use must be waterproofed and terminated appropriately.

## Connecting to the Network

### Assign an IP Address

All Vario2 IPPOE Hybrids have the same default IP address (192.168.2.80) and this must be changed immediately to avoid any potential conflicts or communication errors.

There are two main ways to change the IP address of an illuminator:

#### **OPTION 1: Raytec Discovery Tool**

We recommend the easiest and fastest way to identify and connect to illuminators is using the Raytec Discovery Tool where the IP address can be altered or DHCP enabled. Using the Raytec Discovery Tool avoids the need to have the computer and illuminator in the same network range in order to alter the IP address. This free application is downloadable from our website or please contact Raytec.

To change the IP address using the Raytec Discovery Tool so that you can communicate with the illuminator(s) you can:

#### **Use DHCP**

Run the Raytec Discovery Tool. Single click on illuminator to highlight it. Select **Network** from bottom menu. Highlight DHCP option. Press **OK**, then **OK** again to the “Confirm Changes” dialog box. Press **Discover**. The illuminator should now appear with a valid IP address. You can now double click illuminator to navigate to it.

WARNING: Your network must have DHCP capability.

#### **Manually set the IP address**

Run Raytec Discovery Tool. Single click on illuminator to highlight it. Select **Network** from bottom menu. Type in a new IP address and subnet mask - which must be compatible with your network. Check with your IT manager. After changing the IP address and subnet mask, press **OK**, then **OK** again to the “Confirm Changes” dialog box. Press **Discover**. You can now double click illuminator to navigate to it.

#### **OPTION 2: Use the Illuminators Web Interface**

Alternatively, type the IP address of illuminator into a web browser – default is 192.168.2.80 – and use the web interface using the “Network” tab on the left hand side to manually alter the IP address or enable DHCP. For manual allocation of a static IP address it is important that the network administrator controls and ensures the IP addresses issued are unique and not repeated. In order to establish communication the computer and illuminator must be in the same network range.

In either option above, if DHCP is enabled, your network must have DHCP capability.

Note: - If assigning the IP address fails, check that there is no firewall blocking the operation and that the computer and illuminator have IP addresses in the same range.

### Raytec Discovery Tool Basics

The Raytec Discovery Tool is downloadable from our website or you may request it from Raytec.

During the initial set-up we strongly recommend that you use the Raytec Discovery Tool on a computer on the same network as the Vario2 IPPOE Hybrid illuminators to discover and establish connection.

The illuminator responds to multicast messages - and therefore does not need to have a valid IP address in the same network range for the Raytec Discovery Tool to find it. But it does require a valid IP address for connection and communication. ALL IP addresses need to reside within the same network address range to ensure these components can communicate with each other.

With the Vario2 IPPOE Hybrid powered and attached to the same network, press **Discover** and the Raytec Discovery Tool will display a list of illuminators available on the network.

See instructions above on how to change IP address or enable DHCP in order to allow communication with the illuminator.

Once the IP address of the illuminators have been changed, you can double click on the illuminator from the Raytec Discovery Tool to navigate directly to the illuminators web interface.

The Raytec Discovery Tool allows you to:-

- Discover all illuminators on the network – illuminators do not need a valid IP address to be discovered
- Alter IP address of illuminator – the illuminator must have a valid IP address to allow communication
- Enable DHCP
- Navigate directly to each illuminator – once a valid IP address has been assigned
- See the illuminators status
- See whether the illuminator is ON / OFF
- View the MAC address of each illuminator
- Change Network Settings

- Change the Name and Group Name
- See additional illuminator details including name, firmware version, model and the time the illuminator has been powered.

### Hierarchy of Photocell vs. Telemetry

- The telemetry function enables the choice of wavelength. The photocell must detect that it is dark for the telemetry function to operate.
- The photocell overrides the telemetry function during the day. If the external input/telemetry function needs to be operated 24 / 7, then the photocell function should be disabled from the settings / groups page.
- If the external input/telemetry is not active, then the unit will follow the photocell settings.

The system requires 15 seconds of light to deactivate the photocell and turn the illuminators off to avoid accidental turn off of the illuminators via car headlights or torches.

If illuminators are in groups, the following rules apply:

- ANY sending illuminator within a group which says it is dark will turn all the illuminators in the group on (subject to local illuminator settings)
- ALL illuminators in the group need to say it is light before all the group illuminators will go off together (subject to local conditions)

### Log-in, Security & Basic Illuminator Setup

Log-in using Operator or Administrator user names and passwords. Operator has limited access rights. Administrator has full access rights.

Defaults (User Names & Passwords are case sensitive):

Users & Passwords	Name	Password
Operator	user	password
Administrator	admin	password

In order to maintain maximum security of your system, we recommend you change the passwords at the earliest opportunity (for further information, please see GUI Access page and “Access / Passwords Section” of full installation instructions).

Take instant control of a illuminator by pressing the Override button on the home page. This will countdown for 30 minutes to allow the user to control the illuminator and then will revert to standard settings automatically or if the Override button is deselected. Override is only available when the illuminator mode is set to **Local**, **HTTP + Local** or **VMS + Local**.

To operate the illuminator via a VMS or third party application that uses the Raytec API, then the illuminator mode should be set to **VMS** or **VMS + Local**. In VMS mode the illuminator will ignore Photocell and External Input triggers and respond only to valid VMS commands. In **VMS + Local**

mode the illuminators can be controlled via a VMS system whilst also still responding to local photocell and telemetry triggers.

To operate the illuminator with an application that uses the HTTP API, then the illuminator mode should be set to **HTTP** or **HTTP + Local**. In HTTP mode the illuminator will ignore Photocell and External Input triggers and respond only to valid HTTP commands. In **HTTP + Local** mode the illuminators can be controlled with HTTP commands whilst also still responding to local photocell and telemetry triggers.

VMS integration allows the illuminator(s) to be directly controlled and triggered by events within the VMS environment such as scheduled events, alarm triggers, camera commands, etc.

HTTP Integration allows the illuminator to be directly controlled and triggered on receipt of valid HTTP commands generated on the network from VMS, cameras or other components capable of generating HTTP commands.

The illuminator mode can be changed on the Settings / Groups page. The default illuminator mode is **Local**.

### Standard Setup – Factory Defaults

The illuminator is operating in Local mode and will respond only to its own photocell and telemetry status. By default the illuminator is NOT assigned to a group.

The illuminator will turn ON / OFF automatically when the photocell detects it is dark / light at 100% (soft start) via the photocell.

The External Input will activate the illuminator at 100% (NOT soft start) for the duration of the input provided the photocell detects it is dark.

External Output: activated by photocell and will become active when short circuit, unless changed in advanced settings on the GUI.

### Factory Defaults

Name	VARIO2 IP
Group Name	<<Deliberately Left Blank>>
IP Address	192.168.2.80

Enable DHCP Checkbox	Not Selected – IP addresses will NOT be automatically allocated. If illuminator is being operated on a DHCP enabled network, DHCP can be selected for automatic allocation of IP address.
Illuminator Mode	<i>Local</i> : Control the illuminator using the web interface. Illuminator will respond to its own photocell and telemetry events.

	<i>Photocell</i>	<i>External Input</i>
Trigger Control	Lamp Control	Lamp Control
Light Type	IR	WL
Respond to Group Commands	No, ignore group command	No, ignore group command
Lamp Mode on Trigger	On	On
Power (%)	100%	100%
Duration	All night	Duration of Input
Soft Start	On	Off

Deterrent

Pattern = SOS  
Frequency = Slow

Advanced Settings

Manual Override

Countdown Duration = 30 mins

External Input

Type of Input = Volt Free  
Active State = Short Circuit / Low

External Output

Trigger State = Photocell Only  
Active State = Short Circuit / Low

Photocell

Photocell Sensitivity = 20 lux

Basic Web Page Functionality

All web pages have the following information in the header bar



Model Type / Lamp Name / Group Name

- Home
- Settings/Groups
- Adv. Settings
- Access
- Network
- System Information
- Diagnostics
- Adv. Diagnostics
- Software Update
- Log Off

## Home

This page allows the user to take direct/override control of the lamp or the group of lamps with which this lamp is associated.



Type:Var2-IP-hy6  
Name:VARIO2IP  
Group:Site  
Trig:None  
Status:

Override



Rev 3.0.7c

Copyright © Raytec

User has access to Home Page and Diagnostics pages.  
Administrator has access to all pages.



<u>Page Name</u>	<u>Functions available</u>
Home Page	Allows manual control of an individual illuminator or group of illuminators including power adjustment, wavelength choice and deterrent controls. Select override to operate above functions.
Settings / Groups	Allows detailed set-up and configuration of the illuminator including how it responds to Photocell and External Inputs, light type, duration on period, power levels, soft start, response to group commands, deterrent patterns and speeds. Allows illuminators to be allocated to a group or to create a new group. Selectable control of illuminator either locally, by VMS or HTTP commands.
Adv. Settings	Allows for further detailed setup of External Input, External Output, Photocell sensitivity level and duration of Override.
Access	Change passwords
Network	Allocate IP address and other network settings, select DHCP operation, allocate illuminator name
System Information	Indicates basic information about the illuminator. Ability to restore factory settings or restart illuminator.
Diagnostics	Basic diagnostics to enable 1 <sup>st</sup> level troubleshooting
Adv. Diagnostics	Advanced diagnostics to enable 2 <sup>nd</sup> level troubleshooting
Software Update	Indicates current software / firmware version. Ability to upload updated software / firmware version.
Log Off	We recommend logging off illuminator after every session

## Illuminator web interface note

You may see the model name of your illuminator cut short on the home page of your illuminator like below:



Due to a change to the format of our model names, the size of the illuminator details box above has been increased. If you have previously used a Vario IP PoE on your machine, your browser will have remembered the old style and will re-use this. You can force your browser to pull the size change in by removing temporary Internet files, this procedure is explained for Chrome and Internet Explorer browsers below.

### **Chrome**

1. Hold Ctrl-Shift-Del keys
2. Change drop down box to "the beginning of time"
3. Tick "*Cached images and files*" **ONLY. If others are ticked, untick.**
4. Select *Clear browsing data*

### **Internet Explorer**

1. Hold Ctrl-Shift-Del keys
2. Tick "*Preserve Favourites website data*" and "*Temporary Internet files and website files*" **ONLY. If others are ticked, untick.**
3. Select *Delete*

After performing the steps above, refresh the illuminator home page and the longer illuminator details box will appear.

Instructions for this procedure for other browsers can be found online.

## Ping

The illuminator will respond to a standard Ping command sent to its valid IP address. For the ping command to work the illuminator and computer must reside in the same network range.

## Basic Troubleshoot

- Check if the camera and illuminator are aligned correctly.
- For Infra-Red illumination, ensure that a Day and Night or Black and White camera is used and that the camera switches correctly into night mode.
- Check camera and lens. Is iris fully open at night and set correctly. Ensure camera is fully operational and has correct night time settings and capability.
- Ensure correct illuminator lens angle selected for required distance – check stated performance.
- Check the LED status indicator: if green LED indicator is lit on the bottom of the unit, then the unit is receiving power.
- If powering from PoE, ensure Power Sourcing Equipment (PSE) is suitably rated for the VARIO2 IPPOE HYBRID unit – see page 6 for required ratings – and for all 8 size units check correct PoE Detection Resistance has been selected – see page 7.
- If powering from low voltage 24V DC, check voltage applied and that power supply is suitably rated for the VARIO2 IPPOE HYBRID unit – see page 6 for required ratings.
- Check connection and wiring of CAT5 / 6 cable to VARIO2 IPPOE HYBRID. Verify link has been established with the router / switch to which the illuminator is connected and that the wiring is compatible with T-568B wiring standard.
- If the illuminators are correctly wired to the network, run the Raytec Discovery Tool and try to discover the illuminator on the network.

If the illuminator is discovered and the “State” indicator is grey, this indicates that there is no communications with the illuminator. Ensure IP Address and Subnet Mask of computer and illuminator are set within the same range. If not, alter IP address of illuminator or Enable DHCP on illuminator for automatic allocation of suitable IP address.

Use a Ping command to see if the illuminator and device are on the same network and have communication.

- If still unsuccessful try a different web browser.
- If unit still cannot be discovered then type default IP address into browser: 192.168.2.80
- If no communication possible after above steps, please contact Raytec for further support or consider a Hard Reset of the illuminator.

# Detailed Installation Guide

## Contents

Box Contents: .....	1
Accessories (optional):.....	1
Safety Information.....	2
Product Introduction.....	3
Basic Steps.....	5
Wiring .....	7
PoE Detection – Resistance Selection Switch .....	8
Interchangeable Lenses: Changing the Angle .....	9
Installation .....	10
Connecting to the Network.....	11
Raytec Discovery Tool Basics .....	12
Hierarchy of Photocell vs. Telemetry.....	13
Log-in, Security & Basic Illuminator Setup.....	13
Factory Defaults.....	14
Basic Web Page Functionality.....	15
Illuminator web interface note .....	18
Ping .....	18
Raytec Discovery Tool in Depth .....	23
Network Settings.....	24
DHCP – Automatic allocation of IP address .....	25
Static Network Configuration – Manual allocation of IP address .....	26
Name and Group Name .....	27
Illuminator Status .....	29

Other Information .....	29
Unit Details – Parameters .....	29
<b>Detailed Illuminator Setup: Web Interface Pages .....</b>	<b>31</b>
Log-In Page.....	31
Home Page .....	32
<b>Settings / Groups .....</b>	<b>35</b>
Illuminator Mode .....	36
Groups .....	38
Group Name .....	38
Trigger Control .....	38
Respond to Group Commands.....	39
Lamp Mode On Trigger .....	39
Power .....	40
Duration.....	40
Soft Start.....	41
Deterrent Pattern & Frequency.....	41
<b>Advanced Settings .....</b>	<b>42</b>
Manual Override - Countdown Duration .....	42
External Input – Select type of Input & Active State on Input .....	43
External Output .....	43
Photocell Sensitivity .....	44
<b>Access / Passwords.....</b>	<b>45</b>
<b>Network.....</b>	<b>47</b>
Enable DHCP .....	47
Manual IP Address.....	48
Network - IP Address Changed- Reboot .....	48

Restore Factory Settings .....	49
Reboot / Restart Illuminator .....	49
Diagnostics .....	51
Advanced Diagnostics.....	52
Software Update .....	53
Log Off.....	55
Hard Reset Button – Located on illuminator .....	56
Raytec APIs (VMS and HTTP) .....	57
Troubleshooting & FAQs.....	57

## Raytec Discovery Tool in Depth

The Raytec Discovery Tool can be obtained from the Raytec website. Once installed, run the application and press **Discover**.

The Raytec Discovery Tool will discover and display all Vario2 IPPOE Hybrid Illuminators on your network.

The illuminator responds to multicast messages - and therefore does not need to have a valid IP address in the same network range for the Raytec Discovery Tool to find it. But it does require a valid IP address for connection and communication.

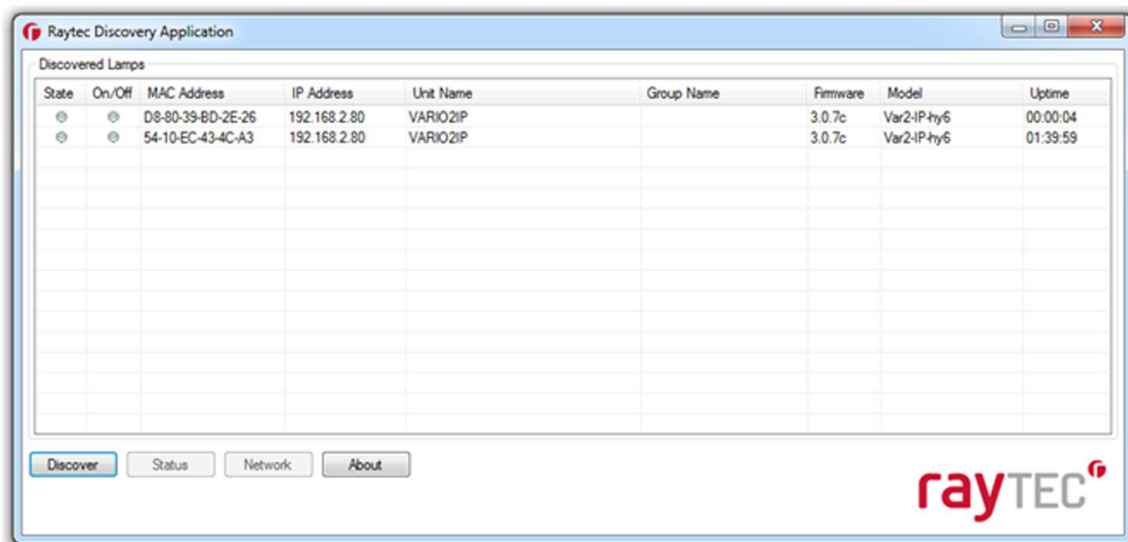

The Raytec Discovery Tool allows you to:-

- Discover all illuminators on the network – illuminators do not need a valid IP address to be discovered
- Alter IP address of illuminator – it must have a valid IP address to allow communication
- Enable DHCP
- Navigate directly to each illuminator – once a valid IP address has been assigned
- See the illuminators status
- See whether the illuminator is ON / OFF
- View the MAC address of each illuminator
- Change Network Settings
- Change the Name and Group Name

- See additional illuminator details including name, firmware version, model and the time the illuminator has been powered.

On the image above, two illuminators have been discovered on the network. They are unique in that they have different MAC addresses, but the same IP Address and Unit Name. The application allows the illuminators to be configured.

### Network Settings

To change the network settings, highlight the illuminator to be changed and press **Network**.

The “Network Configuration” screen will be shown.

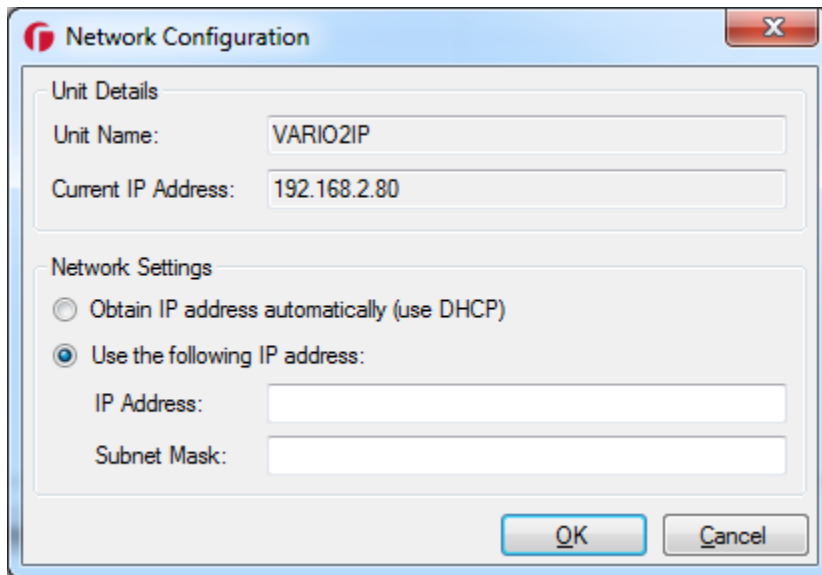

**Network Configuration**

Unit Details

Unit Name: VARIO2IP

Current IP Address: 192.168.2.80

Network Settings

Obtain IP address automatically (use DHCP)

Use the following IP address:

IP Address:

Subnet Mask:

OK Cancel



Two options are available to set the IP Address at this stage:-

1. Enable DHCP – if the network is DHCP enabled
2. Enter a Static IP Address and Subnet Mask

### DHCP – Automatic allocation of IP address

Select *Obtain IP address automatically (use DHCP)* and press *OK*.

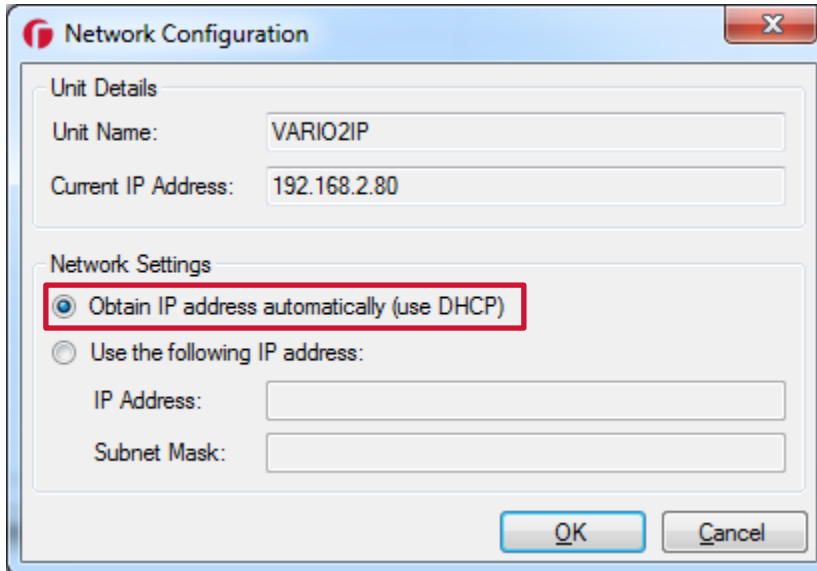

The unit will now be allocated an IP Address via the networks DHCP server. Refresh the Raytec Discovery Tool by pressing *Discover* . The illuminators IP address should automatically be updated into the required range and the illuminator can now be accessed directly from the Raytec Discovery Tool by double clicking on the illuminator from the list of discovered illuminators.

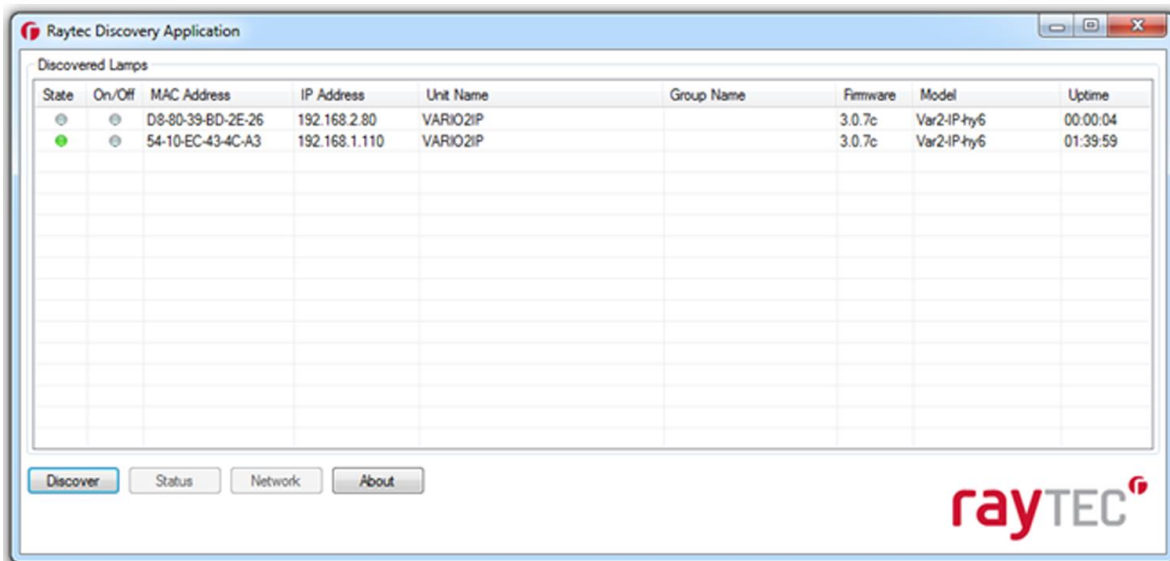

## Static Network Configuration – Manual allocation of IP address

To use static network configuration it is important that the network administrator controls and ensures the IP Addresses issued are unique and not repeated. Enter the appropriate IP Address and Subnet Mask having selected *Use the following IP address* and press **OK**.

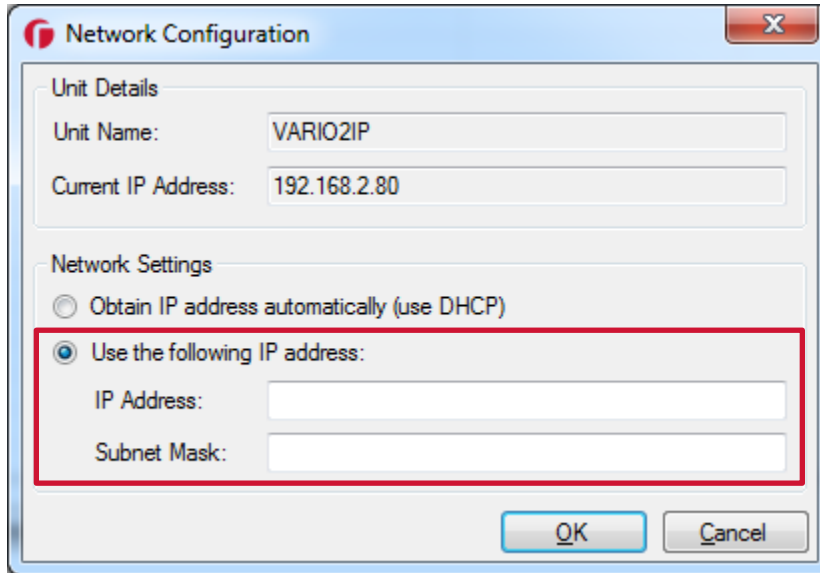

The image shows a 'Network Configuration' dialog box with two sections: 'Unit Details' and 'Network Settings'. In 'Unit Details', 'Unit Name' is 'VARIO2IP' and 'Current IP Address' is '192.168.2.80'. In 'Network Settings', the radio button 'Use the following IP address:' is selected and highlighted with a red box. Below it are empty text boxes for 'IP Address' and 'Subnet Mask'. 'OK' and 'Cancel' buttons are at the bottom.

The unit will now be allocated the IP Address as entered. Refresh the Raytec Discovery Tool by pressing **Discover**.

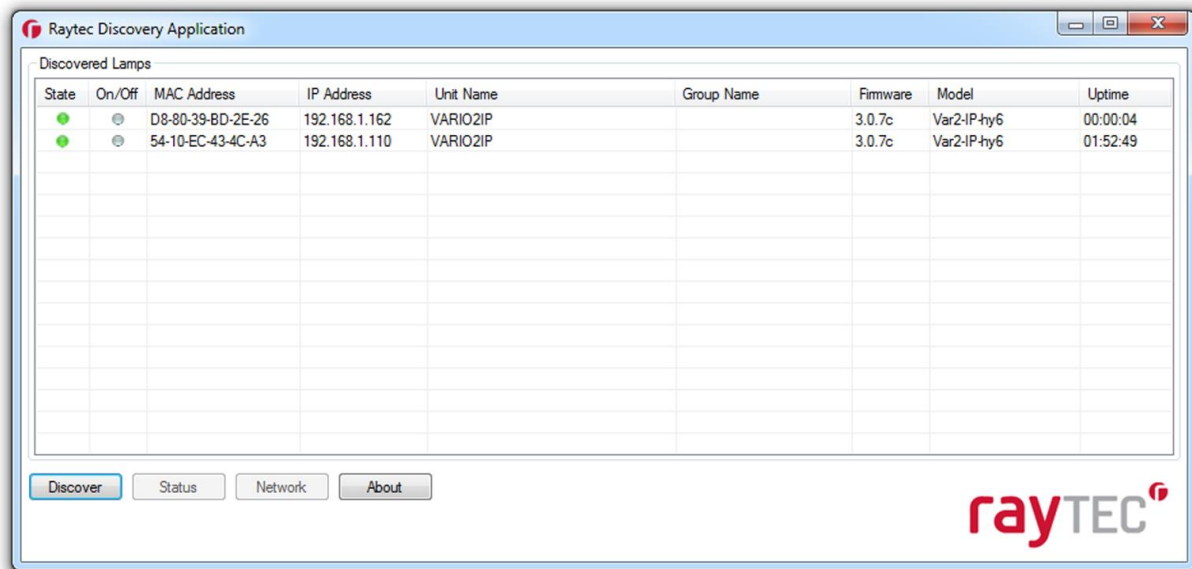

The image shows the 'Raytec Discovery Application' window with a table of discovered lamps. The table has columns for State, On/Off, MAC Address, IP Address, Unit Name, Group Name, Firmware, Model, and Uptime. Two lamps are listed.

State	On/Off	MAC Address	IP Address	Unit Name	Group Name	Firmware	Model	Uptime
●	●	D8-80-39-BD-2E-26	192.168.1.162	VARIO2IP		3.0.7c	Var2-IP-hy6	00:00:04
●	●	54-10-EC-43-4C-A3	192.168.1.110	VARIO2IP		3.0.7c	Var2-IP-hy6	01:52:49

Buttons: Discover, Status, Network, About. Raytec logo is in the bottom right.

## Name and Group Name

All illuminators have the default name of “VARIO2IP”. This should be changed so that the illuminator can be easily identified.

The group name is left blank by default. The group name is used to associate / group illuminators together and allows them to interact using group commands.

Both “Name” and “Group Name” can be modified directly from the Raytec Discovery Tool or via the web interface.

To change these via the Raytec Discovery Tool, highlight the illuminator you want to change. Then press **Status**.

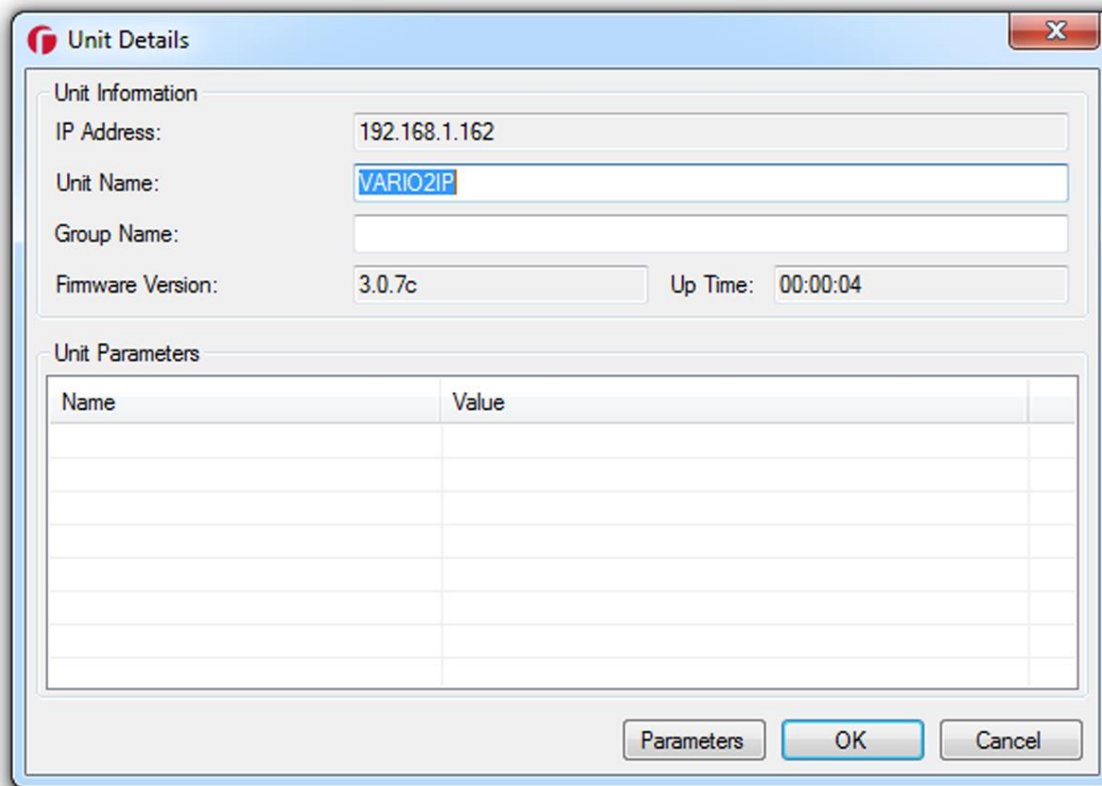

**Unit Details**

Unit Information

IP Address: 192.168.1.162

Unit Name: VARIO2IP

Group Name:

Firmware Version: 3.0.7c Up Time: 00:00:04

Unit Parameters

Name	Value

Parameters OK Cancel

“Unit Name” and “Group Name” can both be edited by entering a new value in their fields.

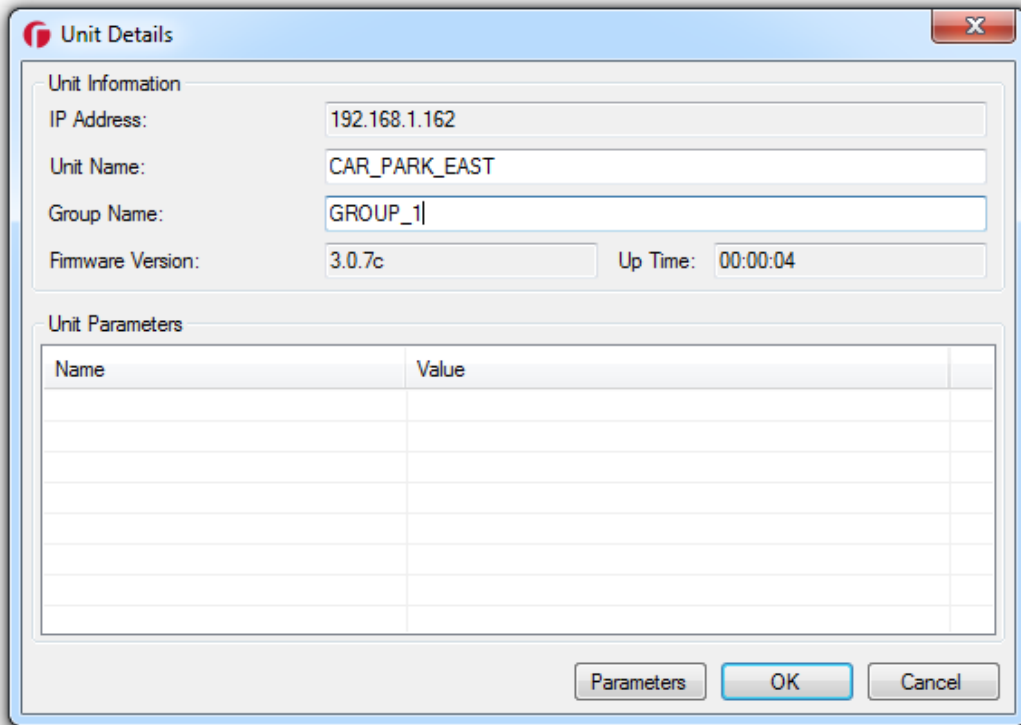

After the change has been made save the edited names by pressing **OK**.

The selected unit name and group have now been changed. Refresh the Raytec Discovery Tool by pressing **Discover** and the updated information should be displayed.

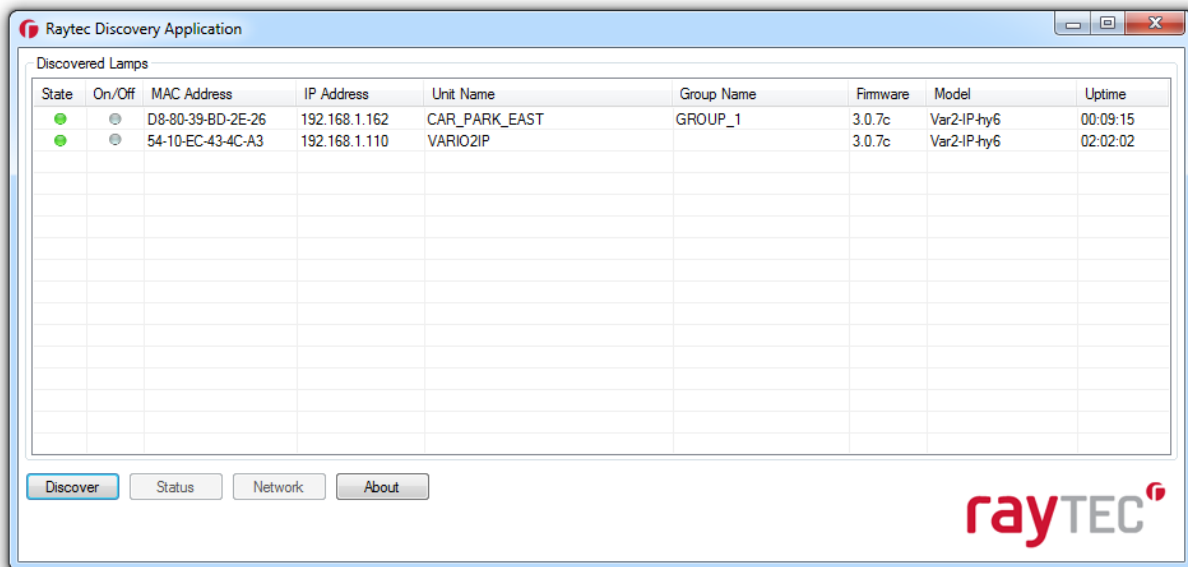

## Illuminator Status

The Raytec Discovery Tool has two status indicators for each illuminator. The colours of these indicators change depending on the state of the illuminators as described below:-

	Red	Green	Grey
State	Illuminator Fault	Illuminator OK	No communication
On / Off	N/A	Illuminator On	Illuminator Off

An illuminator fault is indicated if:-

1. An LED fault exists within the illuminator.
2. The input voltage is outside specified limits.

## Other Information

The Raytec Discovery Tool does not automatically refresh, therefore to view any changes it is important that the page is refreshed by pressing **Discover**.

When changes are made to an illuminator or a new illuminator is added there may be a small delay in making contact or updating the information and so **Discover** may need to be pressed more than once.

## Unit Details – Parameters

Selecting the Parameters button within the “Unit Details” screen provides a high level of detailed information regarding the performance and operation of the illuminator. This is designed to be used during technical support of the illuminator with Raytec or your supplier.

**Unit Details**

Unit Information

IP Address: 192.168.1.162

Unit Name: CAR\_PARK\_EAST

Group Name: GROUP\_1

Firmware Version: 3.0.7c Up Time: 00:09:15

Unit Parameters

Name	Value
NET_ADDR	192.168.1.162
NET_SUBNET	255.255.255.0
NET_GATEWAY	192.168.1.254
NET_DHCP	64
NET_PORT	52055
NET_MCAST	55.0.255.239
DEV_FIRMWARE	3.0.7c
DEV UPTIME	0d, 0h, 11m

Parameters OK Cancel

# Detailed Illuminator Setup: Web Interface Pages

## Log-In Page

Access Log-In Page for individual illuminator by double-clicking on the illuminator from the Raytec Discovery Tool or by typing the IP address into the web browser.

The screenshot shows the Raytec web interface for a Var2-IP-hy6 / VARIO2IP / Site. The header includes the Raytec logo and the text "Raytec Vario2 Hybrid IP Light Controller". A navigation menu on the left lists: Home, Settings/Groups, Adv. Settings, Access, Network, System Information, Diagnostics, Adv. Diagnostics, Software Update, and Log Off. The main content area is titled "User Log On" and contains the instruction "Enter the user name and password to access the lamp." Below this is a login form with two input fields: "User name:" and "Password:". A "Log On" button is positioned below the fields. At the bottom of the page, there is a copyright notice: "Copyright © Raytec".

User Names & Passwords are case sensitive. (Max 32 characters – alphanumeric, symbols allowed)

Log on using either Operator User Name and Password or Administrator User Name and Password.

The Operator only has access to Home Page and Diagnostic Pages only.  
Administrator has access to all pages.

The Administrator can change passwords by using the "Access" Page.  
Ensure you keep a note of passwords used in a secure place.

User	User name	Password
Operator	user	password
Administrator	admin	password

## Forgotten Password

If you are an operator, please request the assistance of the administrator. They can reset the password through the "Access" Web Page.

If you are an administrator, you will have to use the Hard Reset button on the illuminator – refer to Access / Passwords section. This will restore the illuminator to factory defaults which includes user names and passwords.

## Home Page

The screenshot displays the Raytec Vario2 Hybrid IP Light Controller web interface. At the top, the Raytec logo is visible. Below it, a red banner contains the text "Var2-IP-hy6 / VARIO2IP / Site" on the left and "Raytec Vario2 Hybrid IP Light Controller" on the right. A vertical navigation menu on the left side includes the following items: Home, Settings/Groups, Adv. Settings, Access, Network, System Information, Diagnostics, Adv. Diagnostics, Software Update, and Log Off. The main content area is titled "Home" and contains the text: "This page allows the user to take direct/override control of the lamp or the group of lamps with which this lamp is associated." Below this text is an image of the light controller device. To the right of the image, the following information is displayed: Type:Var2-IP-hy6, Name:VARIO2IP, Group:Site, Trig:None, and Status: (indicated by a green light icon). Below the status information is a red "Override" button with a power symbol. At the bottom left of the page, it says "Rev 3.0.7c". At the bottom center, it says "Copyright © Raytec".

After a successful log-in, the Home Page / Manual Override Page will be displayed.

You can navigate to all pages using the side navigator bar which is available on all pages.



The Home Page / Manual Override Page displays the current status of the illuminators including the following information:

- A visual representation of the product and its current state (ON or OFF)
- Product Type & Model
- Product Name - if a name has been assigned (using Network Page or Raytec Discovery Tool)
- Group Name - if a name has been assigned (using Settings / Group Page or Raytec Discovery Tool)
- Trig – if illuminator is on, this will indicate the type of input trigger
- Status – LED indicator will indicate if the illuminator is healthy (green LED) or if there is potentially an issue with the illuminator (amber LED)

### Home Page / Manual Override

All users can access Manual Override features shown below by selecting the **Override** button.

When selected, additional features will appear and Manual Override countdown will commence. Factory default Manual Override countdown is 30 minutes. This setting can be adjusted by the administrator on the “Adv. Settings” Page. The countdown duration can be reset at any time and will restart from maximum time. The Manual Override function can be deselected at any time and the illuminator will return to normal operating mode.

### On & Group On

The current wavelength ON / OFF status will be displayed by the red / green button together with the current power level of the illuminator at its set . Use the slider bar to change the power level.

To turn all illuminators ON in the same group and control power level – select the **Group ON** button.











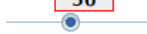

All illuminators in a group will turn on to the power setting selected.

When **ON** or **GROUP ON** button is turned OFF, illuminators will return to their normal operating mode.

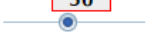
- Home
- Settings/Groups
- Adv. Settings
- Access
- Network
- System Information
- Diagnostics
- Adv. Diagnostics
- Software Update
- Log Off

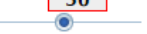
**Home**

This page allows the user to take direct/override control of the lamp or the group of lamps with which this lamp is associated.

 Type:Var2-IP-hy6 Name:VARIO2IP Group:Site Trig:None Status: <b>Override</b>  Duration:00:09 Restart 	<b>IR ON</b>   Power(%) 50 	<b>WL ON</b>   Power(%) 50 	<b>WL DETERRENT</b>  Pattern: SOS Freq: Slow  Power(%) 50 
	<b>IR Group ON</b>	<b>WL Group ON</b>	<b>WL Group DETERRENT</b>
			

Rev 3.0.7c

Copyright © Raytec

Important - If an illuminator is in group override control from another illuminator you will not be able to access the override control on that illuminator.

**Deterrent & Group Deterrent**

This will turn the individual illuminator or all illuminators in the group (if GROUP DETERRENT selected) into deterrent mode. The current pattern and frequency of the deterrent is displayed and can be changed on settings / groups page. Power setting of illuminator(s) in deterrent mode can also be adjusted by using slider bar.

# Settings / Groups

This page is used to configure the operation of the illuminator based on Photocell and / or External Inputs, configure the illuminator to operate in Local, VMS or HTTP mode, assign the illuminator to a Group and configure the deterrent mode of the illuminator.

The illuminator can be configured to operate from the above inputs independently and the power level, duration and soft start function can be configured.



Var2-IP-hy6 / VARIO2IP / Site
Raytec Vario2 Hybrid IP Light Controller

Home

Settings/Groups

Adv. Settings

Access

Network

System Information

Diagnostics

Adv. Diagnostics

Software Update

Log Off

## Settings / Groups

This page allows the administrator to amend settings associated with this lamp.

Press the 'Save' button to store any changes.

**Lamp Mode:** Local

**Name:** VARIO2IP

**Enter Group Name:** Site

or select from existing ▼

	Photocell	Ext Input
Trigger Control:	<span style="border: 1px solid gray; padding: 2px;">Lamp Control</span> ▼	<span style="border: 1px solid gray; padding: 2px;">Lamp Control</span> ▼
Light Type:	<span style="border: 1px solid gray; padding: 2px;">IR</span> ▼	<span style="border: 1px solid gray; padding: 2px;">WL</span> ▼
Respond to Group Commands:	<span style="border: 1px solid gray; padding: 2px;">No, Ignore group commands</span> ▼	<span style="border: 1px solid gray; padding: 2px;">No, Ignore group commands</span> ▼
Lamp Mode On Trigger:	<span style="border: 1px solid gray; padding: 2px;">On</span> ▼	<span style="border: 1px solid gray; padding: 2px;">On</span> ▼
Power (%):	<input style="width: 80%;" type="range"/> <span style="border: 1px solid gray; padding: 2px 5px;">100</span>	<input style="width: 80%;" type="range"/> <span style="border: 1px solid gray; padding: 2px 5px;">100</span>
Duration (mins):	All Night <input checked="" type="checkbox"/> <input style="width: 80%;" type="range"/> <span style="border: 1px solid gray; padding: 2px 5px;">60</span>	Duration of Input <input checked="" type="checkbox"/> <input style="width: 80%;" type="range"/> <span style="border: 1px solid gray; padding: 2px 5px;">60</span>
Soft Start:	<span style="border: 1px solid gray; padding: 2px;">On</span> ▼	<span style="border: 1px solid gray; padding: 2px;">Off</span> ▼

	Pattern	Frequency (Hz)
Deterrent	<span style="border: 1px solid gray; padding: 2px;">SOS</span> ▼	<span style="border: 1px solid gray; padding: 2px;">Slow</span> ▼

Save

Copyright © Raytec

**WARNING:** For changes to take effect, the SAVE button must be pressed

Raytec Global (excluding Americas)  
 Tel: +44 (0) 01670 520055  
 Fax: +44 (0)1670 819760  
 sales@rayteccctv.com

Raytec Americas:  
 Tel: +1 613 270 9990  
 Toll Free: +1 888 505 8335  
 ussales@rayteccctv.com

35

www.rayteccctv.com

**WARNING:** You cannot see the effect of your changes if the *Override* button on the Home Page is still active (green) or your illuminator is in group Override control from another illuminator

## Illuminator Mode

The illuminator can be operated in five different modes:

1. Local
2. VMS
3. VMS + Local
4. HTTP
5. HTTP + Local

These modes are selected in the illuminator mode selection box.

	Photocell	Ext Input
Trigger Control:	Lamp Control ▼	Lamp Control ▼
Light Type:	IR ▼	WL ▼
Respond to Group Commands:	No, Ignore group commands ▼	No, Ignore group commands ▼
Lamp Mode On Trigger:	On ▼	On ▼
Power (%):	<input type="range"/> 100	<input type="range"/> 100

## 1. Local

The illuminator will respond ONLY to photocell and telemetry events. The user may also take direct Manual Override control through the Home Page interface. This is the default setting.

## 2. VMS

The illuminator will respond ONLY to third party VMS systems and any applications that use the Raytec API. The illuminator will NOT respond to photocell and telemetry events. The user CANNOT take direct manual override control through the web interface.

## 3. VMS + Local

The illuminator will respond to third party VMS systems and any applications that use the Raytec API and the illuminator will ALSO respond to photocell and telemetry events. The user may ALSO take direct Manual Override control through the home page of the illuminators web interface.

### **IMPORTANT:**

For detailed instructions on "VMS" and "VMS + Local" modes please refer to the Raytec API Document.

## 4. HTTP

The illuminator will respond ONLY to any device / application generating valid HTTP commands and any applications that use the Raytec HTTP API. The illuminator will NOT respond to photocell and telemetry events. The user CANNOT take direct Manual Override control through the web interface.

## 5. HTTP + Local.

The illuminator will respond to any device / application generating valid HTTP commands and any applications that use the Raytec HTTP API and the illuminator will ALSO respond directly to photocell and telemetry events. The user may ALSO take direct Manual Override control through the web interface.

### **IMPORTANT:**

For detailed instructions on "HTTP" and "HTTP + Local" modes please refer to the Raytec HTTP API Document.

### **VMS Options – Additional Information :**

There is a RaytecAPIInstaller.exe and a Raytec API Quick Start guide available to support VMS integration.

### **HTTP Options – Additional Information :**

There is a Raytec HTTP Command Summary guide and a Raytec HTTP API guide available to support HTTP integration.

## Groups

The Vario2 IPPOE Hybrid illuminator is configured so that it can work individually or as part of a group of illuminators. This group control gives the user more flexibility and capability in terms of how they want their illuminators to operate.

Illuminators can respond to Group commands in three ways and each illuminator can be configured individually to respond to Photocell or External Input triggers:

- **Ignore group commands** – the illuminator will ignore all group commands
- **Yes, Send and Receive** – the illuminator can both originate a group command and will respond to group commands
- **Yes, Receive only** – the illuminator will only respond to group commands

The maximum possible number of illuminators in a group is 16.

Some examples of illuminator functionality in a group:

- All illuminators to come ON at the same time and go OFF at the same time
- One illuminators External Input trigger can turn all illuminators in the group ON (E.g. Car park entrance / Alarm)
- The Group Override function on the Home Page allows the user to take instant control of the group of illuminators all at the same time

## Group Name

An illuminator can be associated with a new or existing group to enable it to follow group commands from the photocell input and / or External Input. A new group name can be created by typing into the “Enter Group Name” box. Ensure that duplicate names are avoided. Or the illuminator can be allocated to an existing group by selecting an existing group from the drop down list of groups.

## Trigger Control

	Photocell	Ext Input
Trigger Control:	Lamp Control ▾ Inactive	Lamp Control ▾ Inactive
Light Type:	Lamp Control Group Control	Lamp Control Group Control
Respond to Group Commands:	No, Ignore group commands ▾	No, Ignore group commands ▾
Lamp Mode On Trigger:	On ▾	On ▾

For both Photocell and External Input, the user can select 3 action states:

1. Inactive                      The illuminator ignores the input
2. Lamp Control              The illuminator will respond to its own input
3. Group Control              The illuminator will respond to an input from illuminators within its group – based on selection from Respond to Group Commands below

**Factory Defaults:**              *Photocell*                      *Lamp Control*  
    *External Input*                      *Lamp Control*

**Respond to Group Commands**

Respond to Group Commands:	No, Ignore group commands ▾	No, Ignore group commands ▾
Lamp Mode On Trigger:	No, Ignore group commands	No, Ignore group commands
	Yes, Send & Receive	Yes, Send & Receive
	Yes, Receive only	Yes, Receive only
Power (%):	<input type="range"/> 100	<input type="range"/> 100

If Group control is NOT selected from Trigger Control options, then the illuminator will not respond to any Group commands.

If Group Control is selected from Trigger Control options, then the user can select two modes of operation in response to Group Commands:

1. Yes, Send & Receive              The illuminator will both originate group commands based on the trigger AND respond to group commands from other illuminators in its group.
2. Yes, Receive only                  The illuminator will only respond to group commands from other illuminators in its group but it will NOT originate any group commands.

**Factory Defaults:**              *Photocell*                      *No, ignore group commands*  
    *External Input*                      *No, ignore group commands*

Some examples of illuminator functionality in a group:

- All illuminators can come on at the same time and go off at the same time by either Photocell or Ext input control from a single illuminator
- The Group Override function on the Home Page allows the user to take instant control of the group of illuminators all at the same time

**Lamp Mode On Trigger**

Lamp Mode On Trigger:	<input type="range"/> On ▾	<input type="range"/> On ▾
	Off	Off
Power (%):	<input type="range"/> On	<input type="range"/> On
		Deter
Duration (mins):	All Night <input checked="" type="checkbox"/>	Duration of Input <input checked="" type="checkbox"/>

This dictates the status of the illuminator on receipt of a valid instruction from Photocell and/or External Input. For both the Photocell and the External Input, the illuminator can either be programmed to stay off or to turn on.

In addition, the External Input can activate the Deter mode – which can be configured below.

**Factory Defaults:**      *Photocell*                      *On*  
   *External Input*                      *On*

### Power

Power (%):		100		100
------------	--	-----	--	-----

This dictates the power level that the illuminator turns on at in response to a valid instruction. Power levels can be set from 20% to 100% using the slider bar.

**Factory Defaults:**      *Photocell*                      *100%*  
   *External Input*                      *100%*

### Duration

Duration (mins):	All Night <input checked="" type="checkbox"/>	Duration of Input <input checked="" type="checkbox"/>	
		60	

This will dictate how long the illuminator will stay on (if ON command is selected) on receipt of a valid instruction.

For the Photocell input the user can select **All Night** in which case the illuminator will stay ON (if ON command is selected) for the whole period of time that the photocell indicates it is dark. Alternatively, a specific time period can be selected using the slider bar.

The timer will only operate whilst the photocell indicates it is dark. If the photocell indicates it is light before the timer has elapsed then the timer is ignored and the light turns OFF.

For the External Input, the user can select **For Duration of Input** in which case the illuminator will stay ON or deter (if ON or deter command is selected) for the whole period of the duration of the input.

Alternatively, a specific time period can be selected using the slider bar. The illuminators will operate immediately and the timer duration starts from the end of the External Input signal. The External Input can be reactivated within the timer period and it will have the effect of restarting the timer.

The illuminator will stay ON until the end of the timed period even if the illuminators photocell states it is daylight.

Min and Max timer settings are:

Photocell Min: 30 mins                      External Input Min:      1 mins  
Photocell Max:                      720 mins                      External Input Max:      60 mins

**Factory Defaults:**      *Photocell*                      *All Night*  
   *External Input*                      *Duration of Input*



**Soft Start**

Soft Start:	On ▾	Off ▾
	Off	Off
	On	On

There is the option, when a valid on instruction is received, for the illuminator to either start immediately (**Soft Start Off**) or to ramp up to selected power level (**Soft Start On**).

The length of time of the ramp up depends on power level selected. (Max 10 seconds for 100% power)

**Factory Defaults:**      *Photocell*                      *On*  
    *External Input*      *Off*

**Deterrent Pattern & Frequency**

	Pattern	Frequency (Hz)
Deterrent	SOS ▾ Wave Hi-Lo SOS	Slow ▾ Slow Medium Fast

There are 3 selectable deterrent patterns available if Deter Feature selected from Illuminator Mode on Trigger:

Traditional SOS pattern                      3 short on/off, 3 longer on/off, 3 short on/off  
 Wave    The illuminator slowly ramps up and down from 100% to 20%  
 Hi-Lo    The illuminator alternates between 100% and 20% power

**Factory Default:**                                      **SOS**

There are 3 selectable deterrent speeds available; Slow, Medium, Fast

**Factory Default:**                                      **Slow**

# Advanced Settings

This page is used to further configure the operation of the illuminator based on more detailed requirements of the Photocell, External Input, External Output and to set the duration of the Override Timer.

The screenshot shows the 'Advanced Settings' page for a Raytec Var2-IP-hy6 VARIO2IP lamp. The interface includes a navigation menu on the left with options like Home, Settings/Groups, Adv. Settings, Access, Network, System Information, Diagnostics, Adv. Diagnostics, Software Update, and Log Off. The main content area is titled 'Advanced Settings' and contains a description: 'This page allows the administrator to amend advanced settings associated with this lamp. Press the 'Save' button to store any changes.' Below this are three sections: 'Manual Override' with a 'Countdown Duration (mins)' dropdown set to 30; 'External Input' with 'Type Of Input' set to 'Volt Free' and 'Active State' set to 'Short Circuit / Low'; and 'External Output' with 'Trigger State' set to 'Photocell Only' and 'Active State' set to 'Short Circuit / Low'. A 'Photocell Sensitivity' slider is also present. A 'Save' button is located at the bottom of the settings area. The footer of the page reads 'Copyright © Raytec'.

## Manual Override - Countdown Duration

There are 8 selectable durations from a drop down list for the Countdown Duration of the Manual Override feature on the Home Page. This determines the amount of time that the user can manually override the illuminator or group of illuminators.

Manual Override		
Countdown Duration (mins)		
Manual Override		30 ▼
		10
		15
		20
External Input		
Type Of Input		Active State
External Input	Volt	Short Circuit / Low ▼
		480

**Factory Default:** 30 minutes

### External Input – Select type of Input & Active State on Input

The External Input wires will accept either volt free or TTL inputs – see polarity on wiring instructions on page 6. The correct type of input must be selected from the drop down list to match the input to ensure correct operation.

The Active State lets the user define the External Input State, either Short or Open Circuit. For example: configuring the setting to Short Circuit will activate the illuminator White Light when the Input is closed, short circuit, Infra-red when it is open circuit.

	Type Of Input	Active State
External Input	Volt Free ▼	Short Circuit / Low ▼
	Volt Free	Short Circuit / Low
<b>External Output</b>	TTL	Open Circuit / High

**Factory Default:** Volt free

**Factory Default:** Short Circuit/Low

### External Output

	Trigger State	Active State
External Output	Photocell Only ▼	Short Circuit / Low ▼
	Disable	Short Circuit / Low
<b>Photocell</b>	Photocell Only	Open Circuit / High
Photocell Sensitivity	Photocell AND Ext I/P	
	Ext I/P	
	Photocell OR Ext I/P	

The External Output is a volt free open / short output.

External Output Trigger State: The drop down box gives you the option to disable the external output signal or make the signal dependant on active states of either the photocell or External Input or a combination of the two. (Photocell Active State = Darkness. External Input Active State = Valid Trigger received.)

The External Output active state, provided above conditions are met, can be selected to be open / high or closed / low.

Note: External Output is triggered by the local illuminator Photocell and the local illuminator External Input only.

**Factory Default:**        *Photocell Only*

**Factory Default:**        *Short Circuit / Low*

### Photocell Sensitivity

The photocell switch-on level can be altered using the slider bar.

Levels are:

Minimum level =        5 lux  
Maximum level =        65 lux

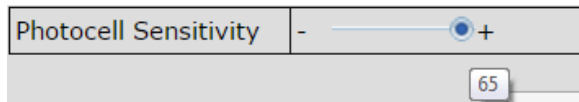

**Factory Default:**        *20 lux*

There is a high level of hysteresis and an in-built delay incorporated to avoid switching ON / OFF in marginal lighting conditions.

**WARNING: For changes to take effect, the SAVE button must be pressed**

## Access / Passwords

**rayTEC**

Var2-IP-hy6 / VARIO2IP / Site Raytec Vario2 Hybrid IP Light Controller

**Home**  
**Settings/Groups**  
**Adv. Settings**  
**Access**  
**Network**  
**System Information**  
**Diagnostics**  
**Adv. Diagnostics**  
**Software Update**  
**Log Off**

**Access**

This page allows the configuration of the lamp's security. The administrator and operator passwords are set here. Operators have restricted access.

**Administrator**

User Name:   
 Password:

**Operator**

User Name:   
 Password:

**Note:**

The 'Administrator' account can access any page.  
 The 'Operator' account can only access the following pages:

- Home
- Diagnostics
- Adv. Diagnostics

Copyright © Raytec

### Caution:

All passwords are case sensitive.  
 Keep a note of all passwords in a safe place.

### Defaults:

User	User name	Password
Administrator	admin	password
Operator	user	password

Only the Administrator can change passwords.

Maximum number of characters:

User Name 32 characters – alphanumeric and symbols allowed

Passwords 32 characters – alphanumeric and symbols allowed

<b>WARNING: For changes to take effect, the <i>SAVE</i> button must be pressed</b>
--

### Recovery of Lost Passwords

If you are an Operator, please request the assistance of the Administrator. They can reset the password through the “Access” web page.

If you are an Administrator, you will have to use the Hard Reset button on the illuminator – refer to “Hard Reset Button – Located on illuminator” Section in the Full Instructions . This will restore the illuminator to factory defaults which includes user names and passwords.

# Network

This page allows the configuration of the illuminators network settings.

**rayTEC**<sup>®</sup>

Var2-IP-hy6 / VARIO2IP / Site Raytec Vario2 Hybrid IP Light Controller

**Home**  
**Settings/Groups**  
**Adv. Settings**  
**Access**  
**Network**  
**System Information**  
**Diagnostics**  
**Adv. Diagnostics**  
**Software Update**  
**Log Off**

### Network

This page allows the configuration of the lamp's network settings.

MAC Address:	D8:80:39:BD:2E:26
Lamp Name	VARIO2IP
<input checked="" type="checkbox"/> Enable DHCP	
IP Address	192.168.1.162
Gateway:	192.168.1.254
Subnet Mask:	255.255.255.0
Primary DNS:	192.168.1.220
Secondary DNS:	192.168.1.221

**CAUTION:** Incorrect settings may cause the lamp to lose network connectivity. Recovery options will be provided on the next page.

Copyright © Raytec

The MAC Address is a unique identifier and cannot be changed

The Illuminator Name can be changed on this page. Avoid duplicates. Maximum number of characters is 15 – alphanumeric.

## Enable DHCP

You may enable DHCP if your network is compatible and then IP addresses will be allocated automatically without creating duplicates.

## Manual IP Address

Alternatively, manually change the IP address into a suitable range for your network by unchecking the "Enable DHCP" box. It is vital to avoid duplicate IP addresses.

Gateway, Subnet Mask, Primary DNS and Secondary DNS can all be changed on this page if "Enable DHCP" is NOT selected.

**WARNING:** Please check with your IT Manager to ensure changes are compatible with your network and the Vario2 IPPOE Hybrid illuminator. We suggest that these settings should only be changed by experienced users.

**WARNING: For changes to take effect, the SAVE button must be pressed**

## Network - IP Address Changed- Reboot

After a network change the system will reboot to ensure that all changes have been applied. The Reboot Screen is shown to instruct the user on how to access the illuminator after the new network settings have been applied.



Var2-IP-hy6 / VARIO2IP / SiteRaytec Vario2 Hybrid IP Light Controller

<b>Home</b>	<h3 style="margin: 0;">Reboot</h3> <p>The the lamp has now been restarted.</p> <p style="text-align: center;"><b>Your lamp is now located at:</b></p> <div style="text-align: center; background-color: red; color: white; padding: 5px; margin: 10px auto; width: 150px;">http://VARIO2IP</div> <p style="text-align: center;"><b>Reconnection Instructions</b></p> <ol style="list-style-type: none"><li><b>1. Did you change the hostname or IP address?</b> It is necessary to clear the address caches in your web browser and OS. From the command prompt in Windows, enter "nbtstat -R" to clear the hostname cache, close your current web browser, open a new web browser, and then try to access the web address above.</li><li><b>2. Did you try the IP address?</b> Try accessing the lamp directly with the IP address you set. (e.g. enter "http://192.168.5.23/" into your browser). If this fails, then the IP address you set is not reachable. Try the step below.</li><li><b>3. Still not working?</b> The factory default settings can be restored to the lamp using the hard reset switch by holding down the reset button for 5 seconds whilst powering up the unit. Refer to the user instruction for location and access of "Hard Reset" switch.</li></ol>
<b>Settings/Groups</b>	
<b>Adv. Settings</b>	
<b>Access</b>	
<b>Network</b>	
<b>System Information</b>	
<b>Diagnostics</b>	
<b>Adv. Diagnostics</b>	
<b>Software Update</b>	
<b>Log Off</b>	

Copyright © Raytec

**Warning:** We strongly recommend that IP addresses are changed via the Raytec Discovery Tool. This is the safest way to ensure that the connection to the illuminator is not lost as a result of setting an invalid IP address. All other settings remain unchanged.



# System Information

This page shows basic information about the illuminator including software version, product type, illuminator name and group name. This is for information only and cannot be altered on this page.

**rayTEC**<sup>®</sup>

**Var2-IP-hy6 / VARIO2IP / Site** **Raytec Vario2 Hybrid IP Light Controller**

**Home**  
**Settings/Groups**  
**Adv. Settings**  
**Access**  
**Network**  
**System Information**  
**Diagnostics**  
**Adv. Diagnostics**  
**Software Update**  
**Log Off**

### System Information

This page presents basic information for the lamp.

**Software Version: 3.0.7c**  
**Product Type: Var2-IP-hy6**  
**Lamp Name: VARIO2IP**  
**Group Name: Site**

**Restore Factory Settings**

Restore Factory Settings will revert the lamp back to factory settings.  
All local settings, including network, lamp name, group name and access accounts will be restored to default values.

**Reboot / Restart Lamp**

Reboot / Restart Lamp will power down the lamp and restart it.  
Settings will not be changed.

Copyright © Raytec

## Restore Factory Settings

At any stage, it is possible to restore ALL the original factory settings of the illuminator. Any settings that have been previously changed will be lost. During the “Restore Factory Settings” the illuminator may come on / flash for a short period.

**WARNING:** Please be aware that this will restore the default IP address of the illuminator, 192.168.2.80, which will likely be out of the normal range of IP addresses on your network. See Pages 10 onwards on how to set the IP address of your illuminator.

## Reboot / Restart Illuminator

It is also possible to reboot / restart the illuminator. The illuminator will restart using the existing settings of the illuminator.

A reboot / restart is generally recommended if a system becomes unresponsive or you want to ensure settings have been reloaded correctly.

During the reboot / restart process the illuminator may come on / flash for a short period.

# Diagnostics

**rayTEC**

Var2-IP-hy6 / VARIO2IP / Site Raytec Vario2 Hybrid IP Light Controller

**Home**  
**Settings/Groups**  
**Adv. Settings**  
**Access**  
**Network**  
**System Information**  
**Diagnostics**  
**Adv. Diagnostics**  
**Software Update**  
**Log Off**

## Diagnostics

This page presents basic diagnostic information for the lamp.  
 To see the latest diagnostic information this page must be refreshed.

<b>Input Voltage Status:</b> <span style="color: green;">●</span>
<b>LED Status*:</b> <span style="color: grey;">●</span>
<b>Photocell Status:</b> Day
<b>Ext.Input Status:</b> Inactive
<b>Auxiliary Output Status:</b> Open
<b>Deterrent Pattern:</b> SOS
<b>Duration - Lamp On:</b> 0 days, 0 hours, 0 minutes
<b>Duration - Power Connected:</b> 0 days, 0 hours, 1 minutes

\* During sub-zero start up the LED status indicator may turn amber until warm up is complete.  
 \* If the lamp is not on the LED status cannot be measured and the status indicator will be grey.

Copyright © Raytec

This page is useful for first level troubleshooting and displays basic diagnostics and information of the illuminator as follows:

Input Voltage Status	Green LED – Input voltage correctly within specified range Amber LED – Potential fault  Check Adv Diagnostics for more information
LED Status	Green LED – All LED strings of illuminator operating correctly Amber LED – Potential fault Grey LED – LED status is unknown e.g. LEDs not currently on.  Check Adv Diagnostics for more information
Photocell Status	Indicates if photocell status is day or night
Ext Input Status	Indicates if external input is being received (active) or not (inactive)
Auxiliary Output Status	Indicates if external output is active (closed) or not (open)

Deterrent Pattern	Indicates which deterrent pattern is selected
Duration – Lamp On	Indicates the amount of time the illuminator has been on
Duration – Power connected	Indicates the amount of time the illuminator has been connected to a power source.

Note: Information on this page is NOT constantly updated or refreshed automatically. To refresh the page, press Function Key F5 or select the page again from the navigation bars on the left.

## Advanced Diagnostics

This page is useful for detailed troubleshooting and displays diagnostics and information about the illuminator. It is intended to be used for detailed troubleshooting with Raytec.



Var2-IP-hy6 / VARIO2IP / Site
Raytec Vario2 Hybrid IP Light Controller

[Home](#)  
[Settings/Groups](#)  
[Adv. Settings](#)  
[Access](#)  
[Network](#)  
[System Information](#)  
[Diagnostics](#)  
[Adv. Diagnostics](#)  
[Software Update](#)  
[Log Off](#)

### Advanced Diagnostics

This page presents advanced diagnostic information for the lamp.

This information will be useful when troubleshooting the lamp with Raytec Technical Support.

<b>Voltage Input: 56.0 Volts</b>
<b>Photocell Voltage: 1643 mVolts.</b>
<b>Model Type Voltage: 2184 mVolts.</b>
<b>Ideal Feedback: 0.00 mVolts.</b>
<b>LED String 1 In: 992 mVolts.</b>
<b>LED String 2 In: 973 mVolts.</b>
<b>LED String 3 In: 499 mVolts.</b>
<b>LED String 4 In: 251 mVolts.</b>
<b>LED String 5 In: 148 mVolts.</b>
<b>LED String 6 In: 90 mVolts.</b>
<b>LED String 7 In: 976 mVolts.</b>
<b>LED String 8 In: 502 mVolts.</b>

Copyright © Raytec

Note: Information on this page is NOT constantly updated or refreshed automatically. To refresh the page, press Function Key F5 or select the page again from the navigation bars on the left.

# Software Update

This page indicates the current version of the software / firmware and also enables the software / firmware to be updated over the network.

**rayTEC**<sup>®</sup>

Var2-IP-hy6 / VARIO2IP / Site Raytec Vario2 Hybrid IP Light Controller

**Home**  
**Settings/Groups**  
**Adv. Settings**  
**Access**  
**Network**  
**System Information**  
**Diagnostics**  
**Adv. Diagnostics**  
**Software Update**  
**Log Off**

## Software Update

This page allows the software / firmware of the lamp to be updated.

**Current Software Version: 3.0.7c**

**To update software, choose file below:**

**File:** Choose file No file chosen

Install New Software

**Note:**

The lamp will restart after the update.

The following lamp settings will remain unchanged after the update:

- All network settings (including current IP address configuration)
- Lamp name and Group name
- Admin account name and password
- User account name and password

All other settings will be reset to their factory default values.

Copyright © Raytec

To upload a new version of software / firmware, please contact Raytec to receive the latest version.

Upload new version onto a computer on the network, **Choose File**, select file to upload – then press **Install New Software**.

We would recommend that the software/firmware update is undertaken when network traffic is low.

The update will restart the unit. From software / firmware version 2.0.0 and above, the following settings will remain unchanged:

- IP Address (if configured statically)
- DHCP mode
- Gateway address

- Subnet mask
- Primary DNS
- Secondary DNS
- Illuminator name
- Group name
- Operator user name and password
- Admin user name and password

All other settings will revert to the Factory Defaults of the new software / firmware version uploaded.

# Log Off

We recommend after using the illuminator web interface that users log off using the Log Off Page.

The screenshot shows the Raytec web interface for the 'Var2-IP-hy6 / VARIO2IP / Site'. The page title is 'Raytec Vario2 Hybrid IP Light Controller'. The navigation menu on the left includes: Home, Settings/Groups, Adv. Settings, Access, Network, System Information, Diagnostics, Adv. Diagnostics, Software Update, and Log Off. The main content area is titled 'Log Off' and contains the following text: 'Logging off will close this window and access to the lamp. You will not be able to take direct / override control of the lamp. You will need to log on to the lamp to be able to take direct / override control.' A 'Log off' button is centered in the main content area. The footer contains the text 'Copyright © Raytec'.

## Hard Reset Button – Located on illuminator

A hardware reset button feature has been provided that will restore ALL factory default settings including IP address, user names and passwords etc. and can be used in cases where communication is lost and the illuminator does not respond.

**WARNING:** We recommend attempting to reconnect with the illuminator by firstly restarting the illuminator or restoring factory settings via the integrated web interface. The hard reset button on the illuminator should be used only as a last resort.

To reset all parameters and the IP address to Factory Default settings:

1. Disconnect power from the illuminator.
2. Remove the baseplate on the illuminator to access the reset button.
3. Press and hold the Reset button and reconnect power.
4. Keep the Reset button pressed for approximately 5 seconds until the illuminator flashes. Release the Reset button.
5. Replace the baseplate securely to ensure unit remains waterproof.

The illuminator can now be discovered using the Raytec Discovery Tool and can be configured as normal following the instructions in this manual. Be aware that the IP address will have been restored to factory default, 192.168.2.80.

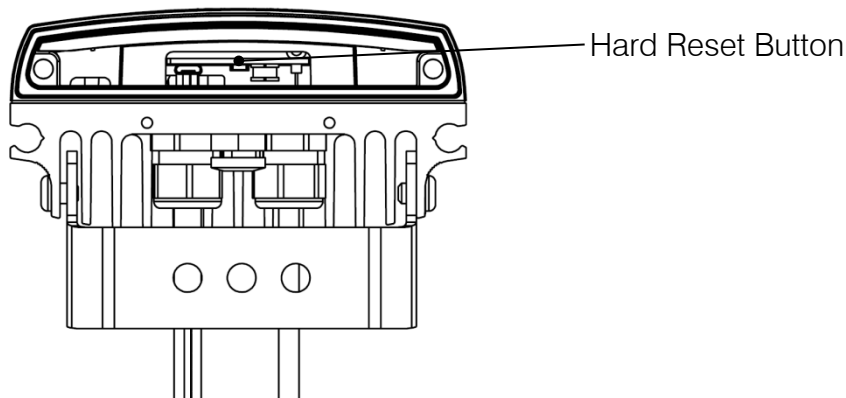



## Raytec APIs (VMS and HTTP)

The Raytec Network Illuminator has been designed such that it can be integrated into 3<sup>rd</sup> party systems such as a VMS, BMS etc. as well as receiving HTTP commands and Raytec have suitable APIs to support such integrations. Please contact Raytec to discuss your particular requirements.

For full documentation to support API implementation, please contact Raytec.

## Troubleshooting & FAQs

### Typical Questions:

*Please see Basic Troubleshooting on pages 18*

Also, please feel free to contact us directly on the contact numbers below.

Can I run the illuminator from auxiliary power? – Yes, *Vario2 IPPOE Hybrid can be operated from PoE power or 24V DC. See page 6.*

What PoE cable type is compatible? – *Use CAT 5 or CAT 6 cable with T-568B wiring standard.*

What is a suitable Power Sourcing Equipment for IP? – *VARIO2 IPPoE hy4 is .at compliant and requires 25.5W minimum. Vario2 IPPOE Hy8 requires an .at handshake and power of 51W minimum.*

I have forgotten my Password. – *If you are an operator, contact your administrator. If you are an administrator, then you may need to perform a hard reset of the illuminator – see previous page.*

I cannot discover my illuminator on the network using the Raytec Discovery Tool. – *Check that there is power to the illuminator, check that the correct CAT 5 / 6 wiring is being used, check that your computers Firewall is allowing the illuminator access and is not blocking UDP traffic.*

I cannot communicate with my illuminator from the Raytec Discovery Tool – *Make sure the IP address of the computer and the illuminator are set to the same range to allow communication. The default IP address of the illuminator is 192.168.2.80.*

My illuminator turns on too early or too late – *First adjust the Photocell Sensitivity on the **Adv. Settings** web page. Make sure the illuminator is not mounted under or next to another another light source which may affect the performance of the photocell.*

I want my illuminator to turn ON via the photocell – *Photocell operation is activated as a factory default setting and will turn the illuminator on/off automatically provided the illuminator is in “Local”, “VMS + Local” or “HTTP + Local” mode. See page 35 for more information.*

My illuminator does not trigger from an external input – *In standard mode, the photocell must detect that it is dark (or be disabled) before the illuminator will respond to an external input. Does your External Input work correctly? Are the respective telemetry wires (orange and purple) wired*

correctly? Has the illuminator been set to trigger from an External input on the illuminators web interface?

My illuminator is not responding to group messages correctly – Are all the illuminators in the same network range with correct IP Addresses and Subnet Masks? Have all illuminators been assigned to the correct group? Trigger Control must be set to “**Group Control**”. Make sure under the “Respond to Group Commands” is set to “**Yes, Receive Only**” or “**Yes, Send and Receive**”. Ensure that if an external trigger is used then that unit is set to “**Yes, Send and Receive**”. Ensure that override function is not running on the illuminators web interface.

## Vario2 IPPOE Hybrid Instruction Guide Rev 1.0.0 Full