

# Robot Vacuum Cleaner



# SAFETY WARNING

## PRODUCT SAFETY PRECAUTIONS



Before using this product, please read all the contents of this user manual carefully, install the device accordingly and save this manual for future reference properly. To lower the risk of fire, electric shock or other injuries, please observe the following operation requirements:

- This appliance is not intended for use by people (including children) with reduced physical, sensory or mental capabilities, or lack of experience and knowledge, unless they have been given supervision or instruction concerning use of the appliance by a person responsible for their safety. Children should be supervised to ensure that they do not play with the appliance.
- For European, this appliance can be used by children aged from 8 years and above and people with reduced physical, sensory or mental capabilities or lack of experience and knowledge if they have been given supervision or instruction concerning use of the appliance in a safe way and understand the hazards involved. Cleaning and user maintenance shall not be made by children without supervision. Children should not play with the appliance.
- Please don't suction high-temperature substances (unextinguished cigarette butts, matches, hot ashes and etc.), superfine substances (like lime, cement, sawdust, gesso, ashes and toner), large sharp fragments (not physically definite matters like glass).
- No action needed to shift the product between 50 and 60Hz, product can adapt itself for both 50 and 60Hz.
- If the supply cord is damaged, it must be replaced by the manufacturer, its service agent or similarly qualified persons in order to avoid a hazard.
- When charging, please use the Auto-empty Base ZD21 offered by EZVIZ.
- **WARNING: To Reduce The Risk Of Electric Shock - Do not use outdoors or on wet surfaces, commercial or industrial environments.**
- **WARNING: To Reduce The Risk Of Electric Shock - Use indoors only.**
- **WARNING: To Reduce The Risk Of Electric Shock – Unplug Before**

## Servicing.

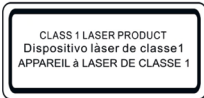

- Do not look directly at the optical interface when the device is working.
- Class 1 laser, output 1.5mW, wavelength 760nm~810nm, IEC 60825-1:2014.
- This product contains a laser with a laser class 1, which is safe under reasonably foreseeable circumstances.
- CAUTION: Changing the function or performance of the optical module arbitrarily without complying with the provisions of this manual may lead to the danger of laser radiation.
- The Auto-empty Base can only charge lithium-ion batteries containing no more than 4 cells with a rated capacity of no more than 4930mAh.
- The Auto-empty Base can not be charged to non-rechargeable batteries.

## PROPER USE OF THE DEVICE

- The device is only used for cleaning the floor of the home environment, and should not be used in outdoor environment (such as open balconies), non-ground environment (such as stairs), and industrial environment.
- Don't use the device in suspended environment (such as duplexes, open balconies and the top of furniture) without protective facilities.
- Children are not allowed to use the device as a toy. Please keep children and pets away from the device when using it. Don't put accessories such as side brush in the place where children can reach, so as to prevent children from eating by mistake. Don't place children and pets on the device body.
- Don't use the device in an environment with open fire or fragile objects.
- Don't use the device on waterlogged floors or wet ground.
- Don't use the device in an environment higher than 40°C or lower than 0°C.
- Don't use the device to clean any flammable materials (such as gasoline,

toner). Don't use the device in the area with flammable materials.

- Don't use the device to clean burning items, such as matches, cigarettes and other items that may cause fire.
- Don't use the product to absorb large stones, waste paper and other items that may block the product. When the suction port is blocked, please clean the product in time and remove the dust, cotton, hair, etc. at the suction port.
- Use only the accessories recommended or sold by the manufacturer. Don't use the batteries or docking station of any third party, and don't use damaged batteries or docking station.
- Dispose of used batteries in accordance with local laws and regulations.
- Don't burn the device under any circumstances, as the battery may cause explosion.
- If the rear surface of the robot is too dusty, it will affect the recharging of the robot. It is recommended to clean it regularly or as needed. It is also recommended to use a paper towel or soft dry cloth to clean it.
- If the surface of the edge sensor on the side of the robot is contaminated with lots of dust, it will affect the posture and mapping positioning effect of the robot when walking along the wall. It is recommended to clean it regularly or as needed. Since the sensor is located inside the body, it is recommended to use the air blowing tool/ paper towel/soft dry cloth for cleaning the camera to wipe the sensor. Don't put your fingers into it for cleaning.
- The bottom of the robot is easy to be contaminated with lots of dust, so it is recommended to clean it regularly or as needed.
- Please use the device according to the instructions in the manual. Any loss and injury caused by improper use shall be borne by the user.
- Please don't touch the plug or any electrified part of the product with your wet hands in case of electric shock hazard.
- If you will not use the product for a long time, please turn off the power and unplug the charging plug.

## Regulatory Information



This product and - if applicable - the supplied accessories too are marked with "CE" and comply therefore with the applicable harmonized European standards listed under the Radio Equipment Directive 2014/53/EU, the EMC Directive 2014/30/EU, the RoHS Directive 2011/65/EU, the ErP Directive 2009/125/EC, the LVD Directive 2014/35/EU.



2012/19/EU (WEEE directive): Products marked with this symbol cannot be disposed of as unsorted municipal waste in the European Union. For proper recycling, return this product to your local supplier upon the purchase of equivalent new equipment, or dispose of it at designated collection points. For more information see: [www.recyclethis.info](http://www.recyclethis.info)



2006/66/EC and its amendment 2013/56/EU (battery directive): This product contains a battery that cannot be disposed of as unsorted municipal waste in the European Union. See the product documentation for specific battery information. The battery is marked with this symbol, which may include lettering to indicate cadmium (Cd), lead (Pb), or mercury (Hg). For proper recycling, return the battery to your supplier or to a designated collection point. For more information see: [www.recyclethis.info](http://www.recyclethis.info)



## DECLARATION OF CONFORMITY

Hereby, Hangzhou EZVIZ Software Co., Ltd. declares that the radio equipment type [CS-RE5P-TWT2] is in compliance with EU Directive 2014/53/EU and UK Radio Equipment Regulations 2017. The full text of the EU and UK declaration of conformity is available at the following web link: <https://www.ezviz.com/page/declaration-of-conformity>.

## EXPOSURE TO RADIOFREQUENCY RF

The frequency bands and the nominal limits of transmitted power (radiated and/or conducted) applicable to this radio device are the following:

<b>Band</b>	Wi-Fi 2.4 GHz
<b>Frequency</b>	From 2.412 GHz to 2.472 GHz
<b>Power transmission [EIRP]</b>	≤100mW

## Technical Parameters

	Class II
	Direct current
	Alternating current
	For indoor use.
	Before charging, read the instructions.

## Robot

<b>Model</b>	CS-RE4P-PWT2
<b>Overall Dimension</b>	345x345x95mm
<b>Battery Capacity</b>	4,930 mAh
<b>Weight</b>	Approx. 3.09kg
<b>Battery Rated Voltage</b>	14.76V
<b>Rated Input</b>	24V $\overline{\text{---}}$ 1.5A MAX
<b>Rated Power</b>	45W

## Auto-empty Base

<b>Model</b>	ZD21
<b>Rated Input Voltage</b>	220-240V~, 50/60Hz
<b>Rated Output</b>	24V $\overline{\text{---}}$ 1.5A MAX
<b>Rated Power</b>	950W
<b>Dimensions</b>	220×180×380 mm

Any and all information, including, among others, wordings, pictures, graphs are the properties of Hangzhou EZVIZ Software Co., Ltd. (hereinafter referred to as “EZVIZ”). This user manual (hereinafter referred to as “the Manual”) cannot be reproduced, changed, translated, or distributed, partially or wholly, by any means, without the prior written permission of EZVIZ. Unless otherwise stipulated, EZVIZ does not make any warranties, guarantees or representations, express or implied, regarding to the Manual.

### **About this Manual**

The Manual includes instructions for using and managing the product. Pictures, charts, images and all other information hereinafter are for description and explanation only. The information contained in the Manual is subject to change, without notice, due to firmware updates or other reasons. Please find the latest version in the EZVIZ™ website (<http://www.ezviz.com>).

### **Revision Record**

New release – January 2023

### **Trademarks Acknowledgement**

EZVIZ™, ™, and other EZVIZ's trademarks and logos are the properties of EZVIZ in various jurisdictions. Other trademarks and logos mentioned below are the properties of their respective owners.

### **Legal Disclaimer**

TO THE MAXIMUM EXTENT PERMITTED BY APPLICABLE LAW, THE PRODUCT DESCRIBED, WITH ITS HARDWARE, SOFTWARE AND FIRMWARE, IS PROVIDED “AS IS”, WITH ALL FAULTS AND ERRORS, AND EZVIZ MAKES NO WARRANTIES, EXPRESS OR IMPLIED, INCLUDING WITHOUT LIMITATION, MERCHANTABILITY, SATISFACTORY QUALITY, FITNESS FOR A PARTICULAR PURPOSE, AND NON-INFRINGEMENT OF THIRD PARTY. IN NO EVENT WILL EZVIZ, ITS DIRECTORS, OFFICERS, EMPLOYEES, OR AGENTS BE LIABLE TO YOU FOR ANY SPECIAL, CONSEQUENTIAL, INCIDENTAL, OR INDIRECT DAMAGES, INCLUDING, AMONG OTHERS, DAMAGES FOR LOSS OF BUSINESS PROFITS, BUSINESS INTERRUPTION, OR LOSS OF DATA OR DOCUMENTATION, IN CONNECTION WITH THE USE OF THIS PRODUCT, EVEN IF EZVIZ HAS BEEN ADVISED OF THE POSSIBILITY OF SUCH DAMAGES.

TO THE MAXIMUM EXTENT PERMITTED BY APPLICABLE LAW, IN NO EVENT SHALL EZVIZ'S TOTAL LIABILITY FOR ALL DAMAGES EXCEED THE ORIGINAL PURCHASE PRICE OF THE PRODUCT.

EZVIZ DOES NOT UNDERTAKE ANY LIABILITY FOR PERSONAL INJURY OR PROPERTY DAMAGE AS THE RESULT OF PRODUCT INTERRUPTION OR SERVICE TERMINATION CAUSED BY: A) IMPROPER INSTALLATION OR USAGE OTHER THAN AS REQUESTED; B) THE PROTECTION OF NATIONAL OR PUBLIC INTERESTS; C) FORCE MAJEURE; D) YOURSELF OR THE THIRD PARTY, INCLUDING WITHOUT LIMITATION, USING ANY THIRD PARTY'S PRODUCTS, SOFTWARE, APPLICATIONS, AND AMONG OTHERS.

REGARDING TO THE PRODUCT WITH INTERNET ACCESS, THE USE OF PRODUCT SHALL BE WHOLLY AT YOUR OWN RISKS. EZVIZ SHALL NOT TAKE ANY RESPONSIBILITIES FOR ABNORMAL OPERATION, PRIVACY LEAKAGE OR OTHER DAMAGES RESULTING FROM CYBER ATTACK, HACKER ATTACK, VIRUS INSPECTION, OR OTHER INTERNET SECURITY RISKS; HOWEVER, EZVIZ WILL PROVIDE TIMELY TECHNICAL SUPPORT IF REQUIRED. SURVEILLANCE LAWS AND DATA PROTECTION LAWS VARY BY JURISDICTION. PLEASE CHECK ALL RELEVANT LAWS IN YOUR JURISDICTION BEFORE USING THIS PRODUCT IN ORDER TO ENSURE THAT YOUR USE CONFORMS TO THE APPLICABLE LAW. EZVIZ SHALL NOT BE LIABLE IN THE EVENT THAT THIS PRODUCT IS USED WITH ILLEGITIMATE PURPOSES.

IN THE EVENT OF ANY CONFLICTS BETWEEN THE ABOVE AND THE APPLICABLE LAW, THE LATTER PREVAILS.

# Table of Contents

<b>Overview</b> .....	<b>9</b>
Package Contents.....	9
Basis .....	10
<b>Quick Start Guide</b> .....	<b>14</b>
Preparation.....	14
Connect the Power Supply to the Auto-empty Base.....	14
Remove Shields .....	15
Charging.....	15
Add Clean Water .....	17
Install Mop Assembly .....	18
Get the EZVIZ App .....	18
Add the Robot to EZVIZ App.....	19
Start Cleaning.....	19
<b>Operations on the EZVIZ App</b> .....	<b>20</b>
<b>Basic Operations</b> .....	<b>20</b>
Power On/off .....	20
Pause Cleaning.....	21
Sleep .....	21
System Resetting .....	21
<b>Routine Maintenance</b> .....	<b>21</b>
Dump the Dust Box.....	22
Clean/replace Mop Assembly.....	23
Clean Water Tank.....	24
Clean the Main Brush.....	24
Clean/Replace the Side Brush .....	25
Clean Universal Wheel .....	26
Clean Sensor .....	27
Clean the Charging Electrode .....	27
Replace the Dust Bag.....	28
Clean the Dust Channel.....	28



**FAQ** ..... 29

**List of Faults** ..... 32

**Appendix** ..... 33

**Environmental Precautions** ..... 33

**Rechargeable Lithium ion Battery** ..... 34

**INFORMATION FOR PRIVATE HOUSEHOLDS** ..... 34

# Overview

## Package Contents



Robot Vacuum Cleaner \*1  
(hereinafter referred as to "Robot")



Auto-empty Base \*1



Side Brush \*2  
(One has pre-installed)

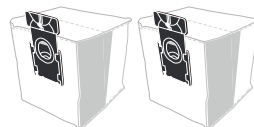

Disposable Dust Bag \*2  
(One has pre-installed)



Cleaning Tool \*1



High-performance Filter \*2  
(One has pre-installed)

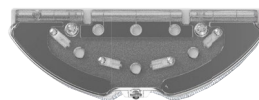

Mop Assembly\*1



Mop Cloth \*1



Quick Start Guide \*2



Regulatory Information \*1

**i** The device's appearance is subject to the actual one you have bought.



# Basis Robot



## Power Switch

For the first use, please toggle the power switch from "0" to "1".

## Button

	Recharge Button	<ul style="list-style-type: none"> <li>Press once: back to charge</li> </ul>
	Clean/On-off Button	<ul style="list-style-type: none"> <li>Press once: Turn on the Robot/Start full-house cleaning (under standby mode)</li> <li>Press twice: Start fixed-point cleaning</li> <li>Press and hold for 4s: Turn off the Robot</li> </ul>
	Clean/On-off Button + Recharge Button	<ul style="list-style-type: none"> <li>Press and hold for 4s: network configuration mode</li> <li>Press and hold for 15s: Restore to factory settings</li> </ul>

## Power Indicator



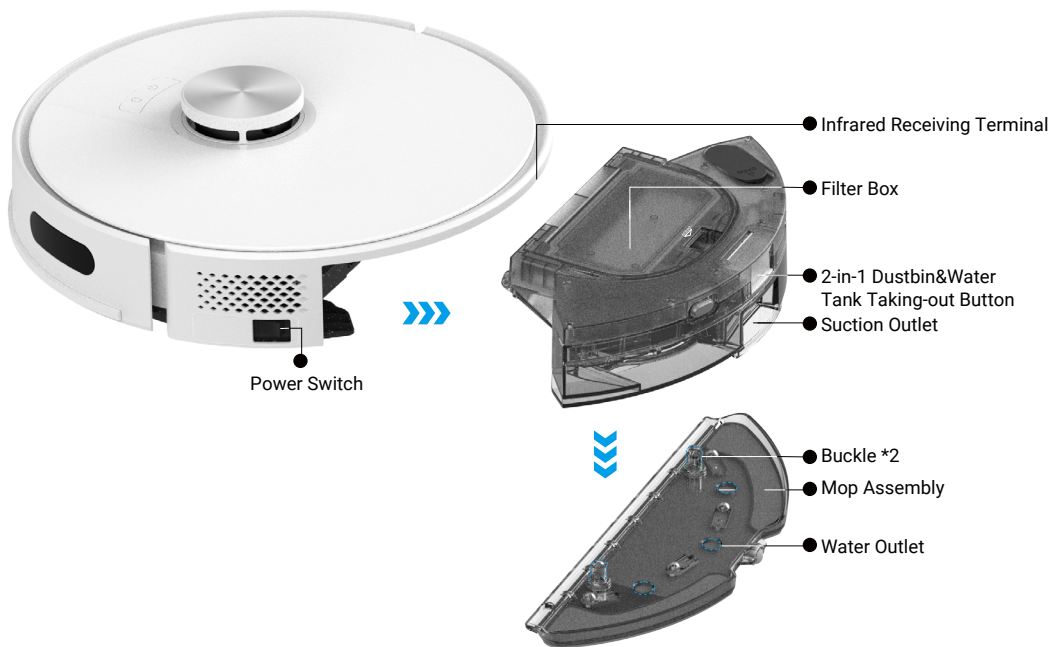
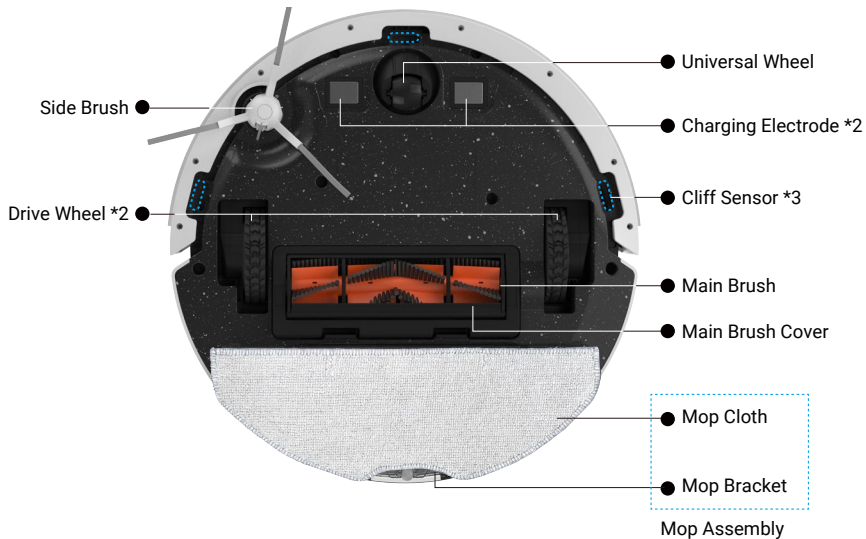

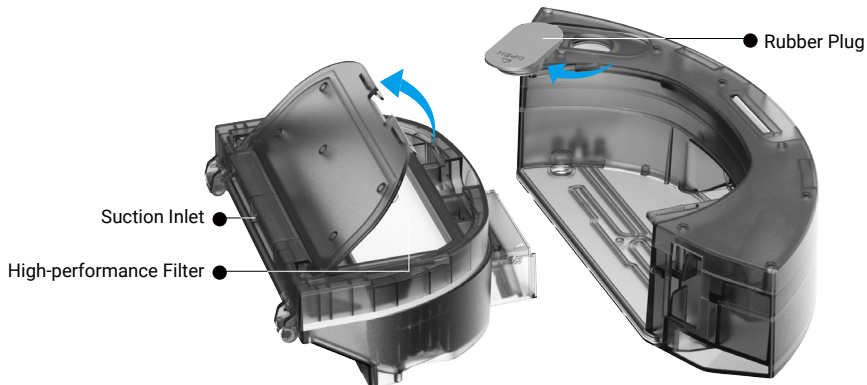
	Power Indicator (on Cleaning/On-off Button & Recharge Button)	<ul style="list-style-type: none"> <li>White: battery level <math>\geq 20\%</math></li> <li>Pink: battery level <math>&lt; 20\%</math></li> <li>Red: fault or exceptions</li> <li>Slow-flashes white: In charging</li> </ul>
--	--	--





## Auto-empty Base



Name	Description	
Auto-empty Base LED Indicator		Solid White: under standby mode
		Off: both of Robot and Auto-empty Base are correctly connected/ the Auto-empty Base is sleeping
		Solid Red: the Dust Bag is not in place
		Fast-flashing Red: abnormal state

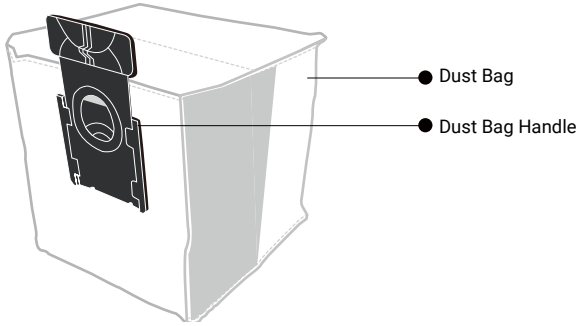

# Quick Start Guide

## Preparation

Try to avoid using in the environment with stairs (if must, please set up a guardrail), and try to remove the obstacles on the ground before use.

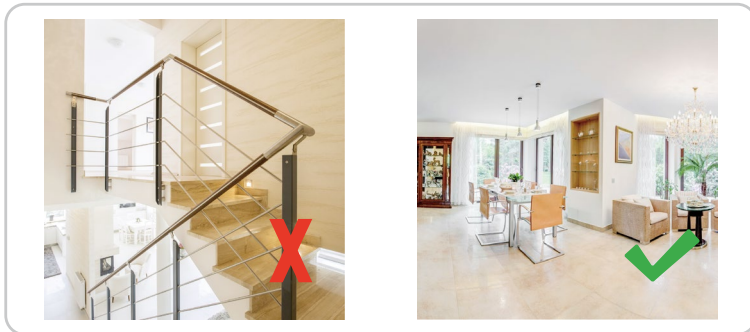

## Connect the Power Supply to the Auto-empty Base

Install the Auto-empty Base in a location that the Robot can easily access. It is recommended to place the Auto-empty Base against a wall, and on a hard-level surface rather than on rugs or carpets.



- In order to avoid external heat damage to the Auto-empty Base, please do not place it next to radiators, heaters, fireplaces, etc.
- For a normal charging process, please do not place the Auto-empty Base in environments subjected to direct sunlight, rain, snow or humidity.

## Remove Shields

Before use, remove the shields on both sides of the Front Bumper and all protective films on both of the Robot and the Auto-empty Base.



## Charging

1. For the first use, please toggle the **power switch** to "I" to turn on the Robot.





2. Place the Robot on the Auto-empty Base and align it with the Charging Electrodes. When the Auto-empty Base Indicator light goes out and the power indicator slow-flashes white, charging will begin.



3. Automatic recharging: the Robot will automatically return for recharging after the cleaning task is completed, or you can do by following figure.

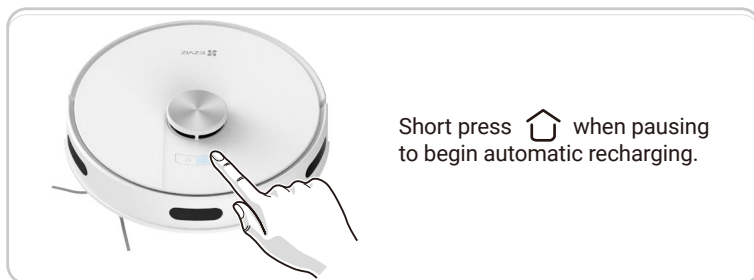

- The Robot needs to be fully charged ( approximately 5 hours) to ensure a normal operation.
- If the Robot is stucked or cannot find the Auto-empty Base, please manually put the Robot back to the the Auto-empty Base.
- When the Robot is being charged or idle, please remove the mop assembly.
- When mopping is paused or finished, the Robot will automatically cut off water. However, the mop cloth remains wet and should not be left in place for too long but removed in time.
- To avoid damaging your wood floor, please make sure to take out the mop assembly immediately after floor mopping is complete.

# Add Clean Water

Take out the 2-in-1 dustbin & water tank.



Open the rubber plug and add clean water to the water tank.

- Please do not add disinfecting water to avoid corrosion of Robot.
- Please wipe the charging contact on the 2-in-1 dustbin and water tank after water added.



# Install Mop Assembly

1. Align the mop bracket with the point as shown in the figure and press them down. Hearing a “click” indicates that they are installed in place.
2. Put the 2-in-1 dustbin & water tank back into the Robot.

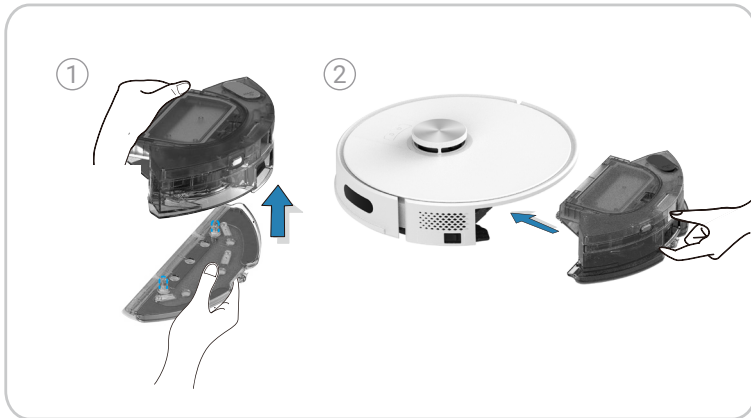

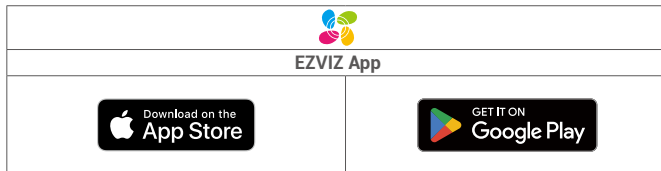

## Get the EZVIZ App





1. Connect your mobile phone to Wi-Fi (only 2.4 GHz WiFi is supported).
2. Download and install the EZVIZ App by searching for “EZVIZ” in the App Store or Google Play™.
3. Launch the App and register an EZVIZ user account.

- If you have already used the App, please make sure that it is the latest version. To find out if an update is available, go to the App store or Google Play™ and search for “EZVIZ”.
- The actual process may vary due to ongoing App updates. Follow the instructions provided in the App.

## Add the Robot to EZVIZ App

1. Log in to your account through EZVIZ App, tap the device adding icon and then the QR code scanning interface will be displayed.
2. Press and hold the  +  on the Robot for 4s until the Power indicator start flashing white and you will hear a voice prompt "start network configuration".
3. Scan the QR code on the Robot body, and complete the network configuration and addition of the Robot according to the interface prompts.

- Before Wi-Fi connection, please ensure the following conditions:
  1. The Robot has enough power (over 20%) or docked to the Auto-empty Base;
  2. The Robot does not support 5GHz Wi-Fi, please connect it with 2.4GHz Wi-Fi.
- If Wi-Fi connection failed, or you want to connect the robot to another Wi-Fi, you need to press and hold the  +  for 4s, and then the robot will be restarted and you can add the robot to EZIVZ App again.



## Start Cleaning

Short press the  button to start the Full-house Cleaning Mode.

Recommended start the Full-house Cleaning Mode when the Robot is on the Auto-empty Base. The Robot will leave the Auto-empty Base to clean the area along the wall, and then clean in a zigzagging way.

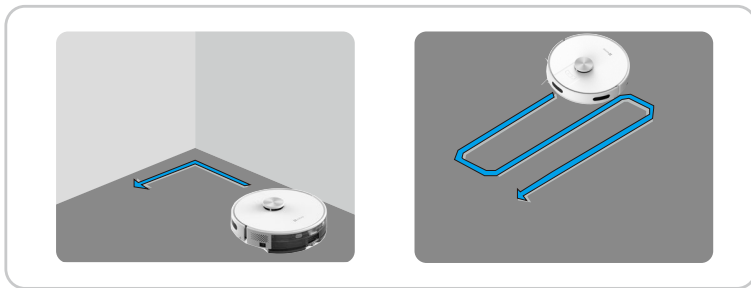

- Do not turn off the power switch during cleaning, otherwise the data of the Robot cannot be saved.
- If the battery level is too low to start cleaning, please charge it first.
- Do not move the Auto-empty Base during cleaning, and make sure that the Auto-empty Base is powered on, otherwise the Robot may not be able to return for charging.
- Under Full-house Cleaning Mode, the Robot will clean twice by default if the cleaning area is less than 10 square meters.

# Operations on the EZVIZ App

**i** The App interface may be different due to version update, and the interface of the App you installed on your phone shall prevail.

## Remote Control Cleaning

Manual remotely-controlled cleaning is available in EZVIZ App to make the Robot go to the area to be cleaned.

## Map for Cleaning

Map editing (area dividing, area merging, area building, room naming, no-go area, invisible wall), map zoning, carpet display, real-time cleaning route display, and multi-map saving.

## Cleaning Method

General cleaning, personalized cleaning, scheduled cleaning, designated room cleaning, and area cleaning.

## Cleaning Settings

Suction setting, water volume setting, cleaning sequence setting, carpet boost.

## Information Display

Cleaning history, Robot power, consumables and maintenance.

## More Features

Firmware upgrade, volume adjustment, Do Not Disturb mode, etc.

# Basic Operations

## Power On/off

Before turn on/off the Robot, please remove it from the Auto-empty Base.

**Power on:** Press the  button once on the operation panel.

**Power off:** When the Robot is not in the Auto-empty Base, press and hold the  button for 4s on the operation panel.

- i** · If the Robot fails to response, please toggle the power switch from "I" to "O" to forcibly turn off it.
- If not in use for a long time, please toggle the power switch to "O".
- If the power switch is in "O" position, the Robot will turn on automatically if placing it on the Auto-empty Base, and will turn off when moving it from the Auto-empty Base.



## Pause Cleaning

Pressing  will pause the Robot while cleaning.

Pressing  will stop the Robot while cleaning, and pressing the button again, the Robot will start returning to the Auto-empty Base.



## Sleep

There are two ways for Robot to switch to Sleep Mode automatically:

- The Robot is inactive and the Auto-empty Base is not connected for 10 minutes.
- There is no operation within 10 minutes after the Robot is fully charged.

 Under the Sleep Mode, the Robot will enter a low energy-consumption state.

## System Resetting

In Standby Mode, press and hold the  +  button for 15s to reset the system.

After resetting the system, the Robot will restore to factory settings.

 Under the Standby Mode, the Robot will stop the current task.

## Routine Maintenance

To maintain the best condition of the device, please maintain the device and replace parts with following frequencies:

Robot Part	Maintenance Frequency	Replacement Frequency
Side Brush	Once every 2 weeks	Every 6-12 months
Main Brush	Once per week	Every 6-12 months
High-performance Filter	Once per week	Every 3-6 months
Edge Sensor Obstacle Sensor Cliff Sensor Infrared Receiving Terminal Bumper Charging Electrode Universal Wheel/Drive Wheel	Once per week	/
Dust Bag	About 90 days	About 90 days
Mop Cloth	/	Every 3-6 months

-  Before performing cleaning and maintenance tasks on the Robot, turn the Robot OFF and unplug the Auto-empty Base.
- A multi-function Cleaning Tool is provided for easy maintenance. Handle with care, this Cleaning Tool has sharp edges.
- EZVIZ manufactures various replacement parts and fittings. Please visit [www.ezviz.com](http://www.ezviz.com) for more information on replacement parts.

# Dump the Dust Box

Take the 2-in-1 dustbin & water tank out, and then take the dustbin out.



Open the top cover of the dustbin and pour out the garbage.



Remove the Filter out of the dustbin.

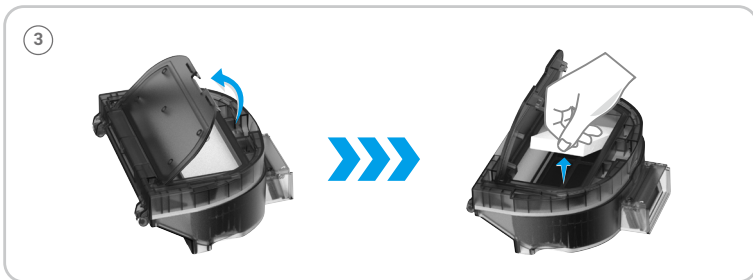

Clean the Filter with Cleaning Tool and flush the Filter and Dustbin thoroughly with water as necessary, and then all cleaned elements shall be thoroughly dried.

**i** Do not clean with hot water or detergent.

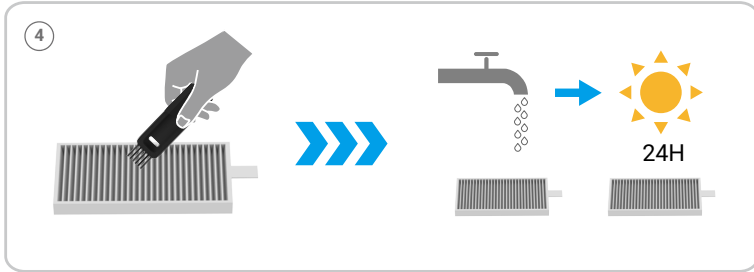

## Clean/replace Mop Assembly

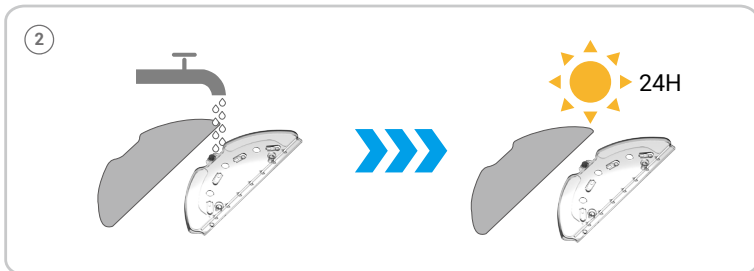



## Clean Water Tank

When not use the Robot for a long time, please empty the water tank.

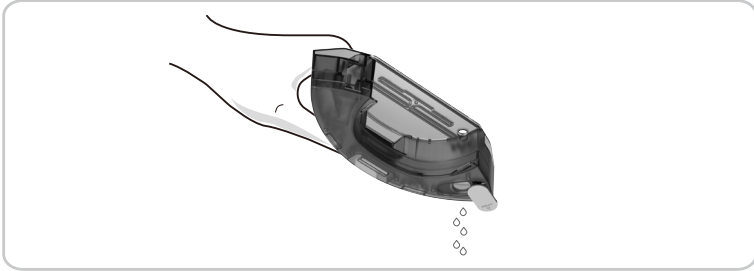

## Clean the Main Brush

Press the buckles to take out the Main Brush cover and the Main Brush.



Use the blade of the Cleaning Tool to cut off the hair entangled on the Main Brush and remove the roller at one end of the Main Brush to clean it, and then re-install the Main Brush into place.

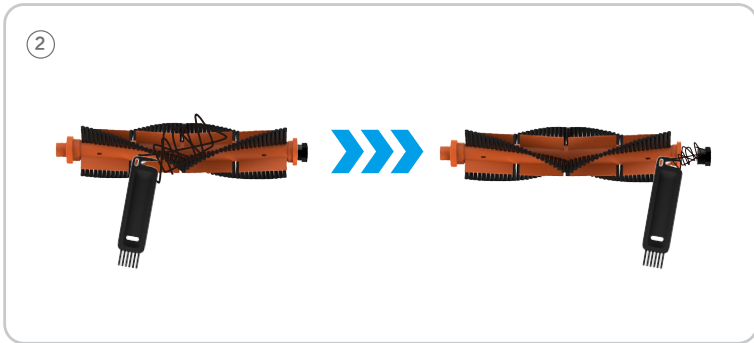

## Clean/Replace the Side Brush

Pull the side brush out and then clean the foreign matters like hairs.

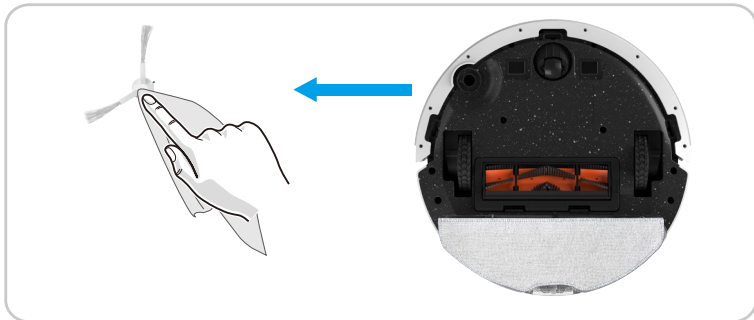

Pull out the old side brush and then press the new one into the position.

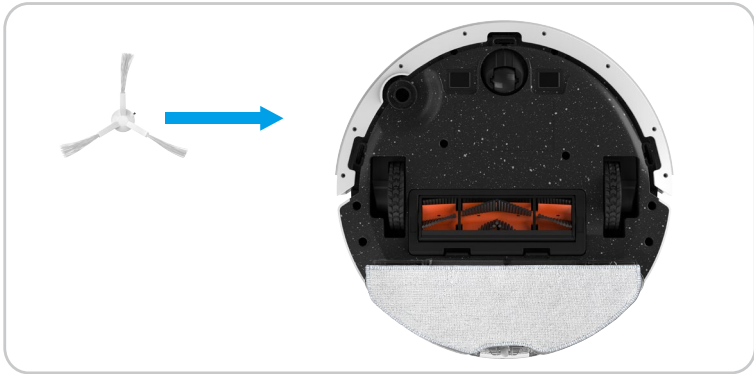

## Clean Universal Wheel

- ① Pull up the Universal Wheel directly by hand then clean it with the hidden Cleaning Tool and then re-install it into place.
- ② Clean the Driven Wheels with the hidden Cleaning Tool.



# Clean Sensor

Wipe dust off with a soft dry cloth or cleaning brush.

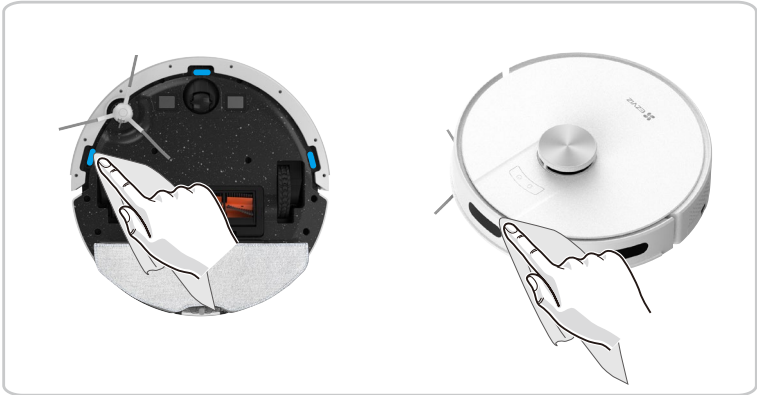

# Clean the Charging Electrode

Wipe off the dust on the Charging Electrodes with a soft dry cloth or cleaning brush.



## Replace the Dust Bag

When the Dust Bag is full, the Auto-empty Base LED Indicator flashes in red.

- ① Open the top cover and pull up the handle of the Dust Bag to take it out;
- ② Install a new one and close the top cover.

**i** Violent disassembly is prohibited.

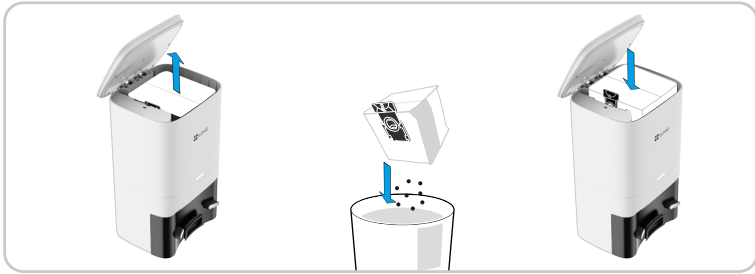

## Clean the Dust Channel

If the Auto-empty Base LED Indicator flashes in red after replacing the Dust Bag, it is recommended to unplug the power plug, reverse the Auto-empty Base to check whether the Dust Channel is blocked by foreign objects.

Use a screwdriver to remove the transparent cover of the Dust Channel, and clean out foreign objects.

**i** Violent disassembly is prohibited.



Problem	Solution
Startup failure	The battery level is low. Please place the Robot on the Auto-empty Base and align with the Charging Electrodes, and then toggle the power switch to "I". (When it is completely out of power, it needs to be charged for a while before automatic startup).
	The ambient temperature is too low (below 0 °C ) or higher than (above 50 °C ). Please use it within the environmental temperature range of 0-40°C .
	Make sure the power switch on side of the Robot is turned on.
Charging failure	Please remove the Robot and check whether the indicator light of the Auto-empty Base is on, and make sure that both ends of the power adapter of the Auto-empty Base are plugged in.
	<p>Poor contact. Please clean up the spring contacts on the Auto-empty Base and the Charging Electrodes on the Robot.</p> <p>Make sure the power switch on side of the Robot is turned on.</p>
Recharge failure	There are lots of obstacles near the Auto-empty Base. Please place or the Auto-empty Base in an open area.
	The Robot is far from the Auto-empty Base. Please place the Robot near the Auto-empty Base and try again.
Abnormal operation	Shut down and restart.
Abnormal noise during cleaning	There may be foreign matter entangled in the Main Brush, Side Brush or Wheels. Please clean up after shutdown.
Decreased cleaning ability or dirt leakage	The Dustbin is full. Please clean the Dust Box.
	The Filter is clogged. Please clean or replace the Filter.
	The Main Brush is entangled by foreign matter. So please clean the Main Brush.
	The suction port is stucked by foreign matters. Please take out the Dustbin and clean it.

Problem	Solution
Cannot connect to Wi-Fi	Poor Wi-Fi signal. Please make sure that the Robot is in a good Wi-Fi signal covered area.
	Wi-Fi connection exception. Please reset Wi-Fi and download the newest EZVIZ App and try again.
	Incorrect password.
	The router is 5GHz, but the Robot only support 2.4GHz.
Scheduled cleaning doesn't work	The battery level is low. Scheduled cleaning will be started when the remaining battery level is $\geq 20\%$ .
whether the Robot consumes power when it is placed on the Auto-empty Base all the time	The power consumption is very low when the Robot is placed on the Auto-empty Base all the time, which helps to keep the battery in the best status of performance.
Whether the Robot needs to be charged for 16 hours for the first three times	No lithium battery has no memory effect when in use, and there is no need to wait when it is fully charged.
After the Robot returns to the Auto-empty Base, automatic dust collection does not start	Please check whether the Auto-empty Base is normally powered on. When the Robot automatically returns for recharging after more than 5 minutes of cleaning, automatic dust collection will be started.
	When the Auto-empty Base LED Indicator is flashing red, Please check: <ul style="list-style-type: none"> <li>· whether the top cover of the Auto-empty Base is not closed or improperly closed;</li> <li>· whether a Dust Bag is installed in the Auto-empty Base.</li> </ul>
	To ensure a smooth dust collection, recommended let the Robot recharge automatically after cleaning (manually moving the Robot back to the Auto-empty Base will cause unstable connection, thus affecting dust collection).
	Please check the Dust Bag regularly to see if it is full, because overloaded Dust Bag may break, block the dust collection pipe and cause damage to the Auto-empty Base.
	If the problem persists after the above possible causes have been considered, the components may be abnormal. Please contact the customer service department.

Problem	Solution
Automatic dust collection is interrupted after startup or garbage collection is not thorough	Check whether the Dustbin is full. If the Dustbin is full, replace it.
	The dust collection outlet of the Dustbin of the Robot is jammed by foreign objects, causing the Dustbin baffle to fail to open.
	Check whether the air duct of the Auto-empty Base is blocked.
	During dust collection, the Robot is moved (Please do not move the Robot during dust collection for fear of damage).
	There may be water in the Dustbin of the Robot, so that dust can not be extracted easily. Please try to prevent the Robot extracting excessive water, which will affect the dust collection performance.
The inner chamber for the Dust Bag of the Auto-empty Base is dirty	Fine particles will pass through the Dustbin and be adsorbed on the inner wall of the dust barrel. Please check and clean up them regularly;
	The Dustbin may be damaged. Please check and replace if necessary
	Severe dirt accumulation in the inner chamber has a certain impact on the fan and air pressure sensor. Recommended to clean up the garbage in the inner chamber regularly.
Overlapped map appeared	Delete the current map and try to build a new one by press (U).

 For additional information about the Robot, please refer to [www.ezviz.com/eu](http://www.ezviz.com/eu).



# List of Faults

The power indicator will flash in red and the buzzer will give a beep in case that there is an abnormality in the operation of the Robot. Please check the table below to solve your problems.

Voice Prompts	Solutions
Error 1: Battery abnormal Please refer to the user manual or EZVIZ App	<ul style="list-style-type: none"><li>•Please open the battery cover to check whether the battery is connected well and try to restart the Robot.</li><li>•The battery temperature is too high or too low. Please wait until the battery temperature becomes normal (0 C ~40 C /32°F~104°F) before operation</li></ul>
Error 2: Wheel abnormal Please refer to the user manual or EZVIZ App	Please check whether there are foreign objects stuck in a wheel and try to restart the Robot.
Error 3: Side brush abnormal Please refer to the user manual or EZVIZ App	Please check whether there are foreign objects stuck in a side brush and try to restart the Robot.
Error 4: Fan abnormal Please refer to the user manual or EZVIZ App	<ul style="list-style-type: none"><li>•Please check whether there are foreign objects stuck in the fan and try to restart the Robot.</li><li>•Please clean the dustbin and filter, and restart the Robot.</li></ul>
Error 5: Main brush abnormal Please refer to the user manual or EZVIZ App	Please remove and clean it, its connections, its Cover and the Suction Inlet. Please try to restart the Robot after cleaning.
Error 6: Water pump abnormal Please refer to the user manual or EZVIZ App	Please clean the water tank, water pump connections on the tank and Robot, the water outlet at the Robot bottom, and check the mop assembly. Please try to restart the Robot after cleaning.
Error 7: Laser sensor abnormal Please refer to the user manual or EZVIZ App	Please check whether there are foreign objects in the laser sensor, and restart the Robot after cleaning.
Error 9: Charging abnormal Please clean the charging contact area.	<ul style="list-style-type: none"><li>•Please check whether the charging area is contaminated, and clean the charging contacts.</li><li>•Please check whether the battery is installed correctly.</li></ul>
Error 10: Robot abnormal Please clean restart the Robot after shutting it down.	Please toggle the power switch to 0 first and then toggle it to I, after that, try to restart the Robot.
Error 12: Operation abnormal Please check whether the power switch is turned on.	Please turn on the power switch.

If the corresponding faults cannot be eliminated by referring to the above methods, please refer to [www.ezviz.com/eu](http://www.ezviz.com/eu).

## Environmental Precautions

The chemical substances contained in the built-in lithium-ion battery of this product may cause environmental pollution. Please remove it before scrapping and send it to a professional battery recycling station for centralized disposal. Steps for removing the battery (the following information is only applicable when discarding the device, not the daily operation instructions):

1. Let the robot run to a low power state that cannot be cleaned without touching the auto-empty base.
2. Turn off the Robot and remove the side brush and dustbin.
3. Turn the Robot over and remove the screws at the bottom.
4. Remove the battery cover.
5. Take out the battery.

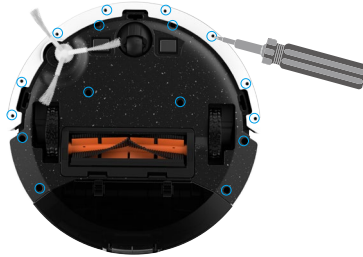

- 1 • When disassembling the battery, please ensure that the power is exhausted and operate with the Auto-empty Base disconnected.
- Please disassemble the whole battery pack together and do not damage the battery pack casing to avoid short circuit or leakage of hazardous substances.
- If the battery has exudate and accidentally touches it, please flush it with plenty of water and seek medical attention promptly.
- This product should not be discarded after the expiration date or after the repair cannot work normally, please hand it over to an enterprise qualified to dispose of WEEE, please refer to the national or local regulations on the disposal of WEEE for the correct method.

# Rechargeable Lithium ion Battery

1. The battery type of the device: Portable battery.
2. The battery of this device is non-removable, which is risky to remove.

Chemical Composition	Chemical Formula	CAS No.	Weight (%)
Lithium transition metal oxide <sup>(2)</sup>	Li <sub>x</sub> MO <sub>2</sub>	182442-95-1	37.3%
Carbon(graphite)	C	7782-42-5	21.0%
Aluminum	Al	7429-90-5	3.27%
Copper	Cu	7440-50-8	7.69%
Steel can	Fe	7439-89-6	13.53%
Electrolyte	C <sub>3</sub> H <sub>4</sub> O <sub>3</sub>	96-49-1	10.67%
	C <sub>4</sub> H <sub>8</sub> O <sub>3</sub>	623-53-0	
	C <sub>3</sub> H <sub>6</sub> O <sub>3</sub>	616-38-6	
	F <sub>6</sub> LiP	21324-40-3	
Others		proprietary	6.54%

## INFORMATION FOR PRIVATE HOUSEHOLDS

1. Separate collection of waste equipment: Electrical and electronic equipment that has become waste is referred to as waste equipment. Owners of waste equipment must dispose of it separately from unsorted municipal waste. In particular, waste equipment does not belong in household waste, but in special collection and return systems.

2. Batteries and rechargeable batteries as well as lamps: Owners of waste equipment shall, as a rule, separate waste batteries and rechargeable batteries that are not enclosed in the waste equipment, which can be removed from the waste equipment without being destroyed, from the waste equipment before handing them in at a collection point. This does not apply if waste equipment is prepared for reuse with the participation of a public waste management authority.

3. Options for returning waste equipment: Owners of waste equipment from private households can return it free of charge to the collection points of the public waste management authorities or to the take-back points set up by manufacturers or distributors within the meaning of the Electrical and Electronics Equipment Law. Stores with a sales area of at least 400 m<sup>2</sup> for electrical and electronic equipment and those grocery stores with a total sales area of at least 800 m<sup>2</sup> that offer electrical and electronic equipment several times a year or on a permanent basis and make it available in the market are required to take it back. This also applies in the case of distribution using means of distance communication, if the storage and shipping areas for electrical and electronic equipment are at least 400 m<sup>2</sup> or the total storage and shipping areas are at least 800 m<sup>2</sup>. Distributors shall, in principle, ensure take-back by providing suitable return facilities at a reasonable distance from the respective end user. The possibility of returning waste equipment free of charge exists for distributors who are obliged to take it back, among other things, if a new similar device that essentially fulfills the same functions is delivered to an end user.

4. Privacy Notice: Waste equipment often contains sensitive personal data. This applies in particular to devices of information and telecommunications technology such as computers and smartphones. In your own interest, please note that each end user is responsible for deleting the data on the waste equipment to be disposed of.

5. Meaning of the symbol “crossed-out wheelee bin”: The symbol of a crossed-out wheelee bin regularly depicted on electrical and electronic equipment indicates that the respective device is to be collected separately from unsorted municipal waste at the end of its service life.